



GENERAL CATALOGUE
2024

EN







Fondital is the first manufacturer of die-cast aluminium radiators worldwide as well as the international leader in heating systems. This is the result of the focus on sustainable innovation in R&D, production renewal related to study of the products, the constant development and training of human resources and the attention to well-being of its employees.

Fondital establishes with its clients strategic partnerships that go beyond a simple supplier-client relationship, but are based on information sharing and customer orientation, maintaining focus on environmental sustainability.





VISION

We want to be an innovative company in the production of efficient and sustainable products, creating strong partnerships with our stakeholders, enhancing our local roots to be a global reference.



MISSION

Our mission is to produce heating systems and structural castings for the automotive sector, manufacturing high-quality products using the latest industrial technologies. We are committed to operating efficiently, minimising our energy consumption and promoting sustainable processes that respect the environment. We also want to be a centre of expertise and added value for the territory in which we operate.

FONDITAL WORLDWIDE

Fondital is market leader internationally. Multilingual staff and representation offices assure a constant presence on the global market, as evidence of its customer oriented vision.

Fondital is constantly growing, thanks to its ability to interpret customer needs and changes, and to the ability to constantly adapt its supply to the new end market needs with process and product innovations.



CONTENTS



CONDENSING BOILERS

PAGE 15

Wall-hung boilers <35kW	page 16
High output boilers >35kW	page 44
Modules	page 50
Floor-standing boilers <35kW	page 62
Technical specifications of condensing boilers	page 64



STANDARD BOILERS

PAGE 81

Wall-hung boilers <35kW	page 82
Technical specifications of standard boilers	page 86



FLUE FITTINGS AND ACCESSORIES

PAGE 89

Flue fittings	page 90
Accessories	page 111



SOLAR THERMAL PRODUCTS

PAGE 117

Collectors	page 118
Systems	page 119
Accessories	page 124



HOT WATER STORAGE TANKS

PAGE 133

hot water storage tanks	page 134
Storage Tanks for Heat Pumps	page 133

PRODUCT RANGE



SOLAR THERMAL SYSTEMS



EXTRUDED RADIATORS



HEAT PUMPS



CONDENSING BOILERS AND STANDARD BOILERS



HOT WATER STORAGE TANKS



DESIGN RADIATORS



DISCOVER THE NEW FONDITAL APP!



Spot, the smart thermostat, allows you to set and monitor your boiler and heating system from wherever you are through a wi-fi connection.

- Smart multizone system with wireless chronothermostat and e-paper display
- Controllable with Amazon Alexa and Google Home
- Compatible with existing systems and with all the boilers of the Fondital domestic range

SPOT
smart thermostat



The app MySpot is available for free for Apple and Android devices



All installation or maintenance operations must be carried out by qualified personnel.

The manufacturer cannot be held responsible for any damage to people, animals and/or things, caused by improper use of the product or by failure to comply with these indications.

FONDITAL AND BIM: INNOVATION IN PROJECT DESIGN

Fondital products full range has been added to BIMobject, the world's largest platform of BIM content.

Therefore, you can download the product files and insert them into the desired project by directly accessing all the specific and detailed information for each prototype.

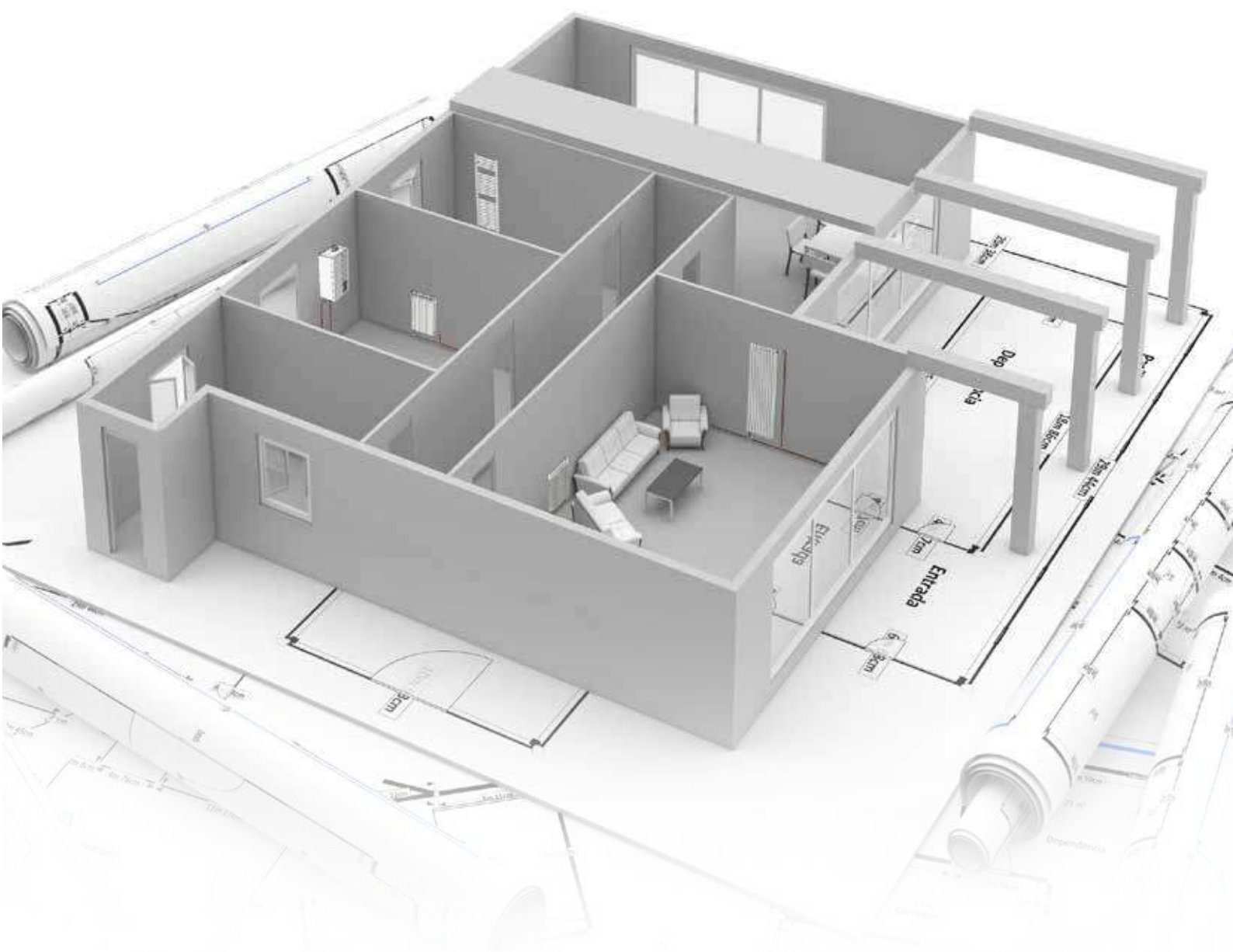

bimobject[®]

Download the Fondital products from www.bimobject.com/en/fondital

BOILERS

CODE OF THE PRODUCT



EXAMPLE

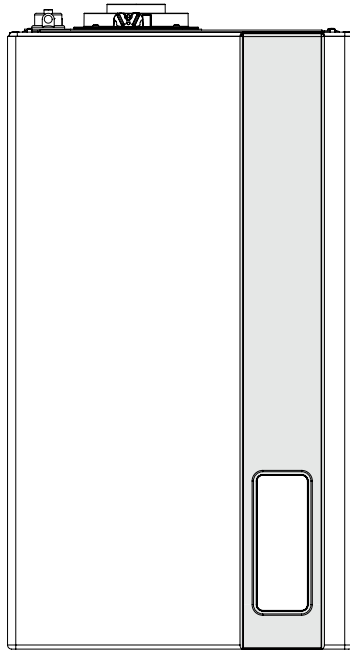

ITACA KC

WALL-HUNG CONDENSING BOILER WITH INSTANT PRODUCTION OF DHW

K = CONDENSING

C = COMBI BOILER WITH INSTANT DHW PRODUCTION

KEY

K	CONDENSING	RB	CH ONLY PLUS 3-WAY VALVE FOR HOT WATER STORAGE TANK
C	COMBI BOILER WITH INSTANT DHW PRODUCTION	S	WITH HYDRAULIC UNIT AND ELECTRONICS FOR MANAGING A SOLAR THERMAL PLANT
B	INTEGRATED HOT WATER STORAGE TANK	TN	NATURAL DRAUGHT
R	CH ONLY	TFS	FORCED DRAUGHT
AF	BI-THERMAL HEAT EXCHANGER	IN	BUILT-IN INSTALLATION

MODEL	CONDENSING	STANDARD	BOILER BODY	CENTRAL HEATING	INSTANTANEOUS DHW PRODUCTION	INTEGRATED STORAGE TANK	REMOTE STORAGE TANK	SOLAR EASY	WALL-HUNG	FLOOR-STANDING	CASCADE-TYPE INSTALLATION	< 35 KW	> 35 KW
ITACA KC	●				●			●	●			●	
ITACA KR	●			●			●	●	●			●	
ITACA KRB	●			●			●	●	●			●	
ITACA KB	●					●		●	●			●	
FORMENTERA KC	●				●			●	●			●	
FORMENTERA KR	●			●			●	●	●			●	
FORMENTERA KRB	●			●			●	●	●			●	
ANTEA NEXT KC	●				●			●	●			●	
ANTEA NEXT KR	●			●			●	●	●			●	
ANTEA NEXT KRB	●			●			●	●	●			●	
ANTEA KC	●				●			●	●			●	
ANTEA KR	●			●			●	●	●			●	
ANTEA KRB	●			●			●	●	●			●	
TENERIFE KC	●				●				●			●	
ITACA CH KR	●			●					●		●		●
ITACA CH KR MODULE FOR INDOOR INSTALLATION	●			●			●		●		●		●
ITACA CH KR CABINET MODULE	●			●							●		●
ITACA CH KR MODULE BACK ON BACK	●			●			●	●	●		●		●
GIAVA KRB	●					●				●		●	
FORMENTERA PRO CTN		●			●			●	●			●	
ANTEA PRO CTN		●			●				●			●	



SYMBOLS



CONDENSING
Condensing boiler



STANDARD
Standard boiler



OUTDOOR INSTALLATION
Boiler that can be installed outdoors, in a partially protected place



INDOOR INSTALLATION
Indoor wall-hung boiler



BUILT-IN INSTALLATION
Boiler to be installed in a suitable flush-mounting unit



FLOOR-STANDING INSTALLATION
Indoor floor-standing boiler



CASCADE-TYPE INSTALLATION
Boiler that can be installed in cascade-type connection



PLATE EXCHANGER
Plate DHW exchanger



26-PLATE HEAT EXCHANGER
26-plate DHW heat exchanger



ALUMINIUM PRIMARY EXCHANGER
Aluminium primary exchanger



STAINLESS STEEL PRIMARY EXCHANGER
Stainless steel heat exchanger



Primary copper heat exchanger
Primary copper heat exchanger



OUTDOOR DHW hot water storage tank
Boiler preset for connection to a remote hot water storage tank



INTEGRATED DHW hot water storage tank
Boiler with hot water storage tank



MODULATION RATIO 1:9
Modulation range of heat output in CH and DHW modes



MODULATION RATIO 1:10
Modulation range of heat output in CH up to 1:10

**SOLAR EASY**

Boiler that can be combined with natural or forced circulation solar systems

**EASY TO CONTROL**

Multilingual menu with detailed access to parameters

**FREEZE PROTECTION**

Boiler self-protection system

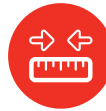
**REDUCED SIZE**

Reduced overall dimensions

**ELECTRONIC IGNITION**

Boiler equipped with electronic flame ignition board

**LOW NOx**

Low NOx emission boiler - class 6

**ENERGETIC SAVING**

Product with high energy efficiency

**TOP COMFORT DHW*****

High-performance boiler for DHW

**FRONT DOOR FOR ACCESS**

Front access for easy maintenance

**COMFORT FUNCTION**

Control for activating DHW comfort function

**HIGH-EFFICIENCY CIRCULATING PUMP**

High efficiency circulating pump for optimised consumption and performance

**MODULATING PUMP**

High efficiency modulating pump to optimize energy consumption and performance

**MADE IN ITALY**

Manufactured in Italy

**IOT - APP**

Control of the home heating system via Smartphone and possibility for the TAC to control all the parameters of the boiler and of the heating system via the home router (with the optional Spot thermostat and MySpot app)



CONDENSING BOILERS

WALL-HUNG BOILERS <35KW

ITACA KC	page 16
ITACA KR	page 18
ITACA KRB	page 20
ITACA KB	page 22
FORMENTERA KC	page 24
FORMENTERA KR	page 26
FORMENTERA KRB	page 28
ANTEA NEXT KC	page 30
ANTEA NEXT KR	page 32
ANTEA NEXT KRB	page 34
ANTEA KC	page 36
ANTEA KR	page 38
ANTEA KRB	page 40
TENERIFE KC	page 42

HIGH OUTPUT BOILERS >35KW

ITACA CH KR	page 44
-------------	---------

MODULES

ITACA CH KR MODULE FOR INDOOR INSTALLATION	page 50
Itaca CH KR module back on back	page 54
ITACA CH KR CABINET MODULE	page 58

FLOOR-STANDING BOILERS <35KW

GIAVA KRB	page 62
-----------	---------

TECHNICAL SPECIFICATIONS OF CONDENSING BOILERS

Technical specifications of condensing boilers	page 64
--	---------



ITACA KC

WALL-HUNG CONDENSING BOILER WITH INSTANTANEOUS PRODUCTION OF DHW CAN BE MATCHED TO OUTDOOR INSTALLATION KIT



- ▶ Ambient temperature probe supplied as standard
- ▶ Modulation ratio: 1:9
- ▶ Condensation also in DHW operation thanks to the thermally insulated 26-plate DHW heat exchanger
- ▶ Management of one heating zone with ambient temperature probe and two zones with zone kit
- ▶ Double filling system: automatic and manual
- ▶ High domestic hot water production, more power during DHW operation (18 - 28 - 30 - 35 kW)
-) Controls to manage two different types of solar thermal systems fitted as standard
-) Thermosetting polymer-covered stainless steel heat exchanger
-) Heating expansion vessel - 10 litres
-) Thermoregulation with external probe (optional)
-) Sanitary comfort function: ★★★
-) High-efficiency modulating circulation pump with built-in air purging device
-) Compatible with SPOT smart thermostat

Available in the following models:

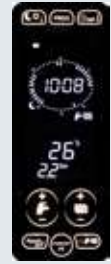

TOUCH SCREEN INTERFACE

- ▶ Modulation thermostat with ambient probe
- ▶ Day/night temperature level selection
- ▶ Weekly programming
- ▶ Timer and ambient temperature setting
- ▶ DHW "comfort" function enabling: ★★★

The TOUCH SCREEN interface of ITACA KC combined with the ambient temperature probe supplied is a class V temperature control system.

Model	Gas type	Code	Heat input		Energy efficiency class		W x H x D mm	Gross weight kg
			Nominal (Qn) kW	Nominal DHW kW	Room heating	Heating DHW		
KC 12	NATURAL GAS	KITXX2KC12	12,0	18,0	A	A _M	420x750x315	35,5
	PROPANE	KITXX6KC12						
KC 24	NATURAL GAS	KITXX2KC24	23,7	27,3	A	A _{XL}	420x750x315	38,0
	PROPANE	KITXX6KC24						
KC 28	NATURAL GAS	KITXX2KC28	26,4	30,4	A	A _{XL}	420x750x315	39,0
	PROPANE	KITXX6KC28						
KC 32	NATURAL GAS	KITXX2KC32	30,4	34,5	A	A _{XXL}	420x750x315	40,5
	PROPANE	KITXX6KC32						

DIMENSIONS AND CONNECTION CENTRE DISTANCES

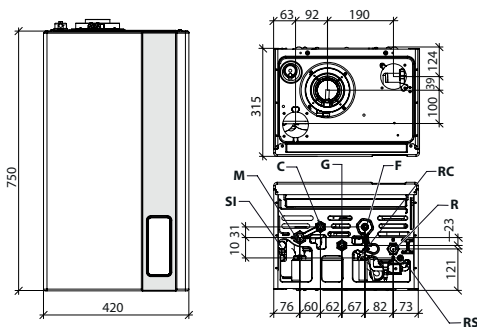

- SI Condensate drain
- M CH system flow (3/4")
- C DHW outlet (1 1/2")
- G Gas inlet (1/2")

- F Cold water inlet (1/2")
- RC Filler tap
- R CH system return (3/4")
- RS Discharge tap



Technical data	um	KC 12	KC 24	KC 28	KC 32
Rated output (Pn)	kW	12	23	26	29
Seasonal energy efficiency of ambient heating (η_s)	%	90	92	92	93
Seasonal energy efficiency of ambient heating (η_s) (Boiler + ambient temperature probe)	%	93	95	95	96
Water heating energy efficiency (η_{wh})	%	78 (**)	85 (**)	84 (**)	87 (**)
Nominal heat input (Qn)	kW	12,0	23,7	26,4	30,4
Nominal heat output (80-60°C) (Pn)	kW	11,7	23,0	25,5	29,4
Heat output (50-30°C)	kW	12,6	25,0	28,0	32,3
Reduced heat input (Qr)	kW	2,0	3,0	3,3	4,2
Useful efficiency at nominal input (80-60°C)	%	97,1	96,8	96,7	96,8
Useful efficiency at nominal input (50-30°C)	%	105,1	105,6	106,0	106,2
Useful efficiency at 30% (30°C return)	%	106,0	107,4	107,4	108,3
Heating expansion vessel capacity	l	10	10	10	10
DHW nominal heat input	kW	18,0	27,3	30,4	34,5
Specific DHW flow $\Delta T=30K$	l/min	8,8	13,4	15,5	16,2
NOx emission class	-	6	6	6	6
Electric protection rating	IP	IPX5D	IPX5D	IPX5D	IPX5D

(**) with comfort function disabled.

For other technical specifications, see from page 64 - Maximum length of flue gas venting, see page 90

Item	Description	Code	Item	Description	Code				
	Coaxial kit \varnothing 60/100 length 75cm	0CONDASP00		Kit for connection to solar plant	0KITSOLC07				
	Remote control, ErP V class (118x85x32 mm)	0CREMOTO04		Tap kit with filter KC-KRB-CT-RBT	0KITRUBI05				
	Thermostat starter kit + Spot gateway	0SPOTAPP01		Magnetic dirt separator filter	0AFILDEF00				
	Zone expansion for Spot thermostat	0EXPSPOT01	For other accessories, see from page 89						
	Coaxial fitting kit \varnothing 60/100	0KITATCO00	Accessories supplied as standard <table border="1"> <thead> <tr> <th>Item</th> <th>Description</th> </tr> </thead> <tbody> <tr> <td></td> <td>Ambient temperature probe</td> </tr> </tbody> </table>			Item	Description		Ambient temperature probe
Item	Description								
	Ambient temperature probe								
	Splitter kit \varnothing 80+80	0KITSDOP08							
	Electrical kit for zone management with external probe	0KITZONE05							
	External probe (60x45x31 mm)	0SONDAES01							

ITACA KC supplied with ambient temperature probe has a room heating seasonal efficiency of: 94% for model 12; 95% for model 24; 95% for model 28; 96% for model 32



How to increase energy efficiency?

Discover the most suitable solution

Seasonal energy efficiency of ambient heating (η_s)						
Regulation device		Code	KC 12	KC 24	KC 28	KC 32
Option 1	Boiler + external probe (ambient temperature probe is not supplied)	0SONDAES01	92%	94%	94%	95%
Option 2	Boiler + external probe (ambient temperature probe is supplied)	0SONDAES01	94%	96%	96%	97%
Option 3	Boiler + remote control (ambient temperature probe is not supplied)	0CREMOTO04	93%	95%	95%	96%
Option 4	Boiler + remote control + external probe (ambient temperature probe is not supplied)	0CREMOTO04	94%	96%	96%	97%
		0SONDAES01	94%	96%	96%	97%

ITACA KR

WALL-HUNG CONDENSING BOILER CH ONLY
CONNECTION TO AN EXTERNAL HOT WATER STORAGE TANK (OPTIONAL) WITH
EXTERNAL 3-WAY VALVE (OPTIONAL)



- ▶ Ambient temperature probe supplied as standard
- ▶ Modulation ratio: 1:9
- ▶ Multifunction relay for connection to systems with zone valves or to solar plant or to remote alarm signal
- ▶ Management of one heating zone with ambient temperature probe and two zones with zone kit
- ▶ Standard management of one type of solar thermal system
- ▶ External hot water storage tank heating setting (optional)
- ▶ Thermosetting polymer-covered stainless steel heat exchanger
- ▶ Heating expansion vessel - 10 litres
- ▶ Thermoregulation with external probe (optional)
- ▶ Automatic by-pass
- ▶ High-efficiency modulating circulation pump with built-in air purging device
- ▶ Compatible with SPOT smart thermostat

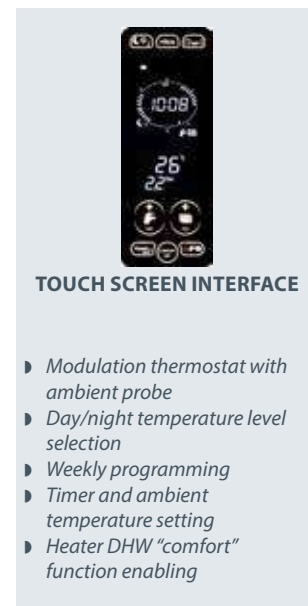

Available in the following models:



The TOUCH SCREEN interface of ITACA KR combined with the ambient temperature probe supplied is a class V temperature control system.

Model	Gas type	Code	Heat input		Energy efficiency class	W x H x D mm	Gross weight kg
			Nominal (Qn) kW	Nominal DHW kW			
KR 12	NATURAL GAS	KITXX2KR12	12,0	18,0 (*)	A	420x750x315	34,0
	PROPANE	KITXX6KR12					
KR 24	NATURAL GAS	KITXX2KR24	23,7	27,3 (*)	A	420x750x315	35,5
	PROPANE	KITXX6KR24					
KR 28	NATURAL GAS	KITXX2KR28	26,4	30,4 (*)	A	420x750x315	37,0
	PROPANE	KITXX6KR28					
KR 32	NATURAL GAS	KITXX2KR32	30,4	34,5 (*)	A	420x750x315	38,5
	PROPANE	KITXX6KR32					

(*) with optional hot water storage tank.

DIMENSIONS AND CONNECTION CENTRE DISTANCES

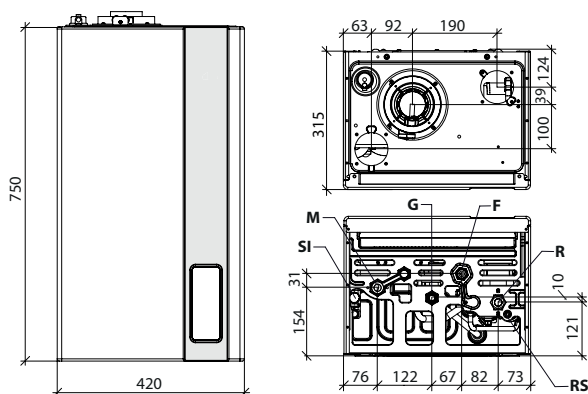

SI Condensate drain
M CH system flow (3/4")
G Gas inlet (1/2")

F Cold water inlet (1/2")
R CH system return (3/4")
RS Discharge tap



Technical data	um	KR 12	KR 24	KR 28	KR 32
Rated output (Pn)	kW	12	23	26	29
Seasonal energy efficiency of ambient heating (η_s)	%	90	92	92	93
Seasonal energy efficiency of ambient heating (η_s) (Boiler + ambient temperature probe)	%	93	95	95	96
Nominal heat input (Qn)	kW	12,0	23,7	26,4	30,4
Nominal heat output (80-60°C) (Pn)	kW	11,7	23,0	25,5	29,4
Heat output (50-30°C)	kW	12,6	25,0	28,0	32,3
Reduced heat input (Qr)	kW	2,0	3,0	3,3	4,2
Useful efficiency at nominal input (80-60°C)	%	97,1	96,8	96,7	96,8
Useful efficiency at nominal input (50-30°C)	%	105,1	105,6	106,0	106,2
Useful efficiency at 30% (30°C return)	%	106,0	107,4	107,4	108,3
Heating expansion vessel capacity	l	10	10	10	10
DHW nominal heat input	kW	18,0 (*)	27,3 (*)	30,4 (*)	34,5 (*)
NOx emission class	-	6	6	6	6
Electric protection rating	IP	IPX5D	IPX5D	IPX5D	IPX5D

(*) with optional hot water storage tank.

For other technical specifications, see from page 65 - Maximum length of flue gas venting, see page 90

Item	Description	Code	Item	Description	Code				
	Coaxial kit Ø 60/100 length 75cm	0CONDASP00		External probe (60x45x31 mm)	0SONDAES01				
	Remote control, ErP V class (118x85x32 mm)	0CREMOTO04		Tap kit with filter KR-KB-RT	0KITRUBI04				
	Thermostat starter kit + Spot gateway	0SPOTAPP01		Magnetic dirt separator filter	0AFILDEF00				
	Zone expansion for Spot thermostat	0EXPSPOT01		Coax. adapter kit D.60/100 to D.80/125	0KITADCO00				
	Coaxial fitting kit Ø60/100	0KITATCO00	For other accessories, see from page 89						
	Splitter kit Ø80+80	0KITSODOP08	Accessories supplied as standard <table border="1"> <thead> <tr> <th>Item</th> <th>Description</th> </tr> </thead> <tbody> <tr> <td></td> <td>Ambient temperature probe</td> </tr> </tbody> </table>			Item	Description		Ambient temperature probe
Item	Description								
	Ambient temperature probe								
	hot water storage tank temperature probe 3m	0KITSOND00							
	Electrical kit for zone management with external probe	0KITZONE05							

ITACA KR supplied with ambient temperature probe has a room heating seasonal efficiency of: 93% for model 12; 95% for model 24; 95% for model 28; 96% for model 32



How to increase energy efficiency?

Discover the most suitable solution

Seasonal energy efficiency of ambient heating (η_s)						
Regulation device		Code	KR 12	KR 24	KR 28	KR 32
Option 1	Boiler + external probe (ambient temperature probe is not supplied)	0SONDAES01	92%	94%	94%	95%
Option 2	Boiler + external probe (ambient temperature probe is supplied)	0SONDAES01	94%	96%	96%	97%
Option 3	Boiler + remote control (ambient temperature probe is not supplied)	0CREMOTO04	93%	95%	95%	96%
Option 4	Boiler + remote control + external probe (ambient temperature probe is not supplied)	0CREMOTO04	94%	96%	96%	97%
		0SONDAES01	94%	96%	96%	97%

ITACA KRB

WALL-HUNG CONDENSING BOILER, CH ONLY, WITH INTEGRATED 3-WAY VALVE CONNECTION TO AN EXTERNAL HOT WATER STORAGE TANK (OPTIONAL)



Available in the following models:



- ▶ Ambient temperature probe supplied as standard
- ▶ Temperature probe for water tank supplied as standard
- ▶ Modulation ratio: 1:9
- ▶ Multifunction relay for connection to systems with zone valves or to solar plant or to remote alarm signal
- ▶ Management of one heating zone with ambient temperature probe and two zones with zone kit
- ▶ Standard management of one type of solar thermal system
- ▶ Integrated 3-way deviating valve
 -) Thermosetting polymer-covered stainless steel heat exchanger
 -) Thermoregulation with external probe (optional)
 -) Heating expansion vessel - 10 litres
 -) High-efficiency modulating circulation pump with built-in air purging device
 -) Anti-legionella function for hot water storage tank
 -) External hot water storage tank heating setting (optional)
 -) Compatible with SPOT smart thermostat



TOUCH SCREEN INTERFACE

- ▶ Modulation thermostat with ambient probe
- ▶ Day/night temperature level selection
- ▶ Weekly programming
- ▶ Timer and ambient temperature setting
- ▶ Heater DHW "comfort" function enabling

The TOUCH SCREEN interface of ITACA KRB combined with the ambient temperature probe supplied is a class V temperature control system.

Model	Gas type	Code	Heat input		Energy efficiency class	W x H x D	Gross weight
			Nominal (Qn) kW	Nominal DHW kW	Room heating	mm	kg
KRB 12	NATURAL GAS	KITXX2KU12	12,0	18,0 (*)	A	420x750x315	36,5
	PROPANE	KITXX6KU12					
KRB 24	NATURAL GAS	KITXX2KU24	23,7	27,3 (*)	A	420x750x315	37,0
	PROPANE	KITXX6KU24					
KRB 28	NATURAL GAS	KITXX2KU28	26,4	30,4 (*)	A	420x750x315	38,5
	PROPANE	KITXX6KU28					
KRB 32	NATURAL GAS	KITXX2KU32	30,4	34,5 (*)	A	420x750x315	40,0
	PROPANE	KITXX6KU32					

(*) with optional hot water storage tank.

DIMENSIONS AND CONNECTION CENTRE DISTANCES

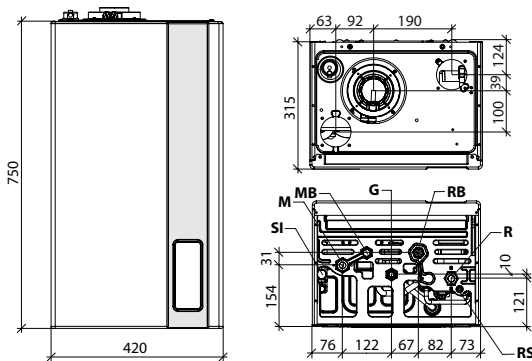

- SI Condensate drain
- M CH system flow (3/4")
- MB Flow for hot water storage tank (1/2")
- G Gas inlet (1/2")

- RB Return from hot water storage tank (1/2")
- R CH system return (3/4")
- RS Discharge tap



Technical data	um	KRB 12	KRB 24	KRB 28	KRB 32
Rated output (Pn)	kW	12	23	26	29
Seasonal energy efficiency of ambient heating (η_s)	%	90	92	92	93
Seasonal energy efficiency of ambient heating (η_s) (Boiler + ambient temperature probe)	%	93	95	95	96
Nominal heat input (Qn)	kW	12,0	23,7	26,4	30,4
Nominal heat output (80-60°C) (Pn)	kW	11,7	23,0	25,5	29,4
Heat output (50-30°C)	kW	12,6	25,0	28,0	32,3
Reduced heat input (Qr)	kW	2,0	3,0	3,3	4,2
Useful efficiency at nominal input (80-60°C)	%	97,1	96,8	96,7	96,8
Useful efficiency at nominal input (50-30°C)	%	105,1	105,6	106,0	106,2
Useful efficiency at 30% (30°C return)	%	106,0	107,4	107,4	108,3
Heating expansion vessel capacity	l	10	10	10	10
DHW nominal heat input	kW	18,0 (*)	27,3 (*)	30,4 (*)	34,5 (*)
NOx emission class	-	6	6	6	6
Electric protection rating	IP	IPX5D	IPX5D	IPX5D	IPX5D

(*) with optional hot water storage tank.

For other technical specifications, see from page 66 - Maximum length of flue gas venting, see page 90

Item	Description	Code	Item	Description	Code
	Coaxial kit Ø 60/100 length 75cm	0CONDASP00		External probe (60x45x31 mm)	0SONDAES01
	Remote control, ErP V class (118x85x32 mm)	0CREMOTO04		Tap kit with filter KC-KRB-CT-RBT	0KITRUBI05
	Thermostat starter kit + Spot gateway	0SPOTAPP01		Coax. adapter kit D.60/100 to D.80/125	0KITADCO00
	Zone expansion for Spot thermostat	0EXSPOT01	For other accessories, see from page 89		
	Coaxial fitting kit Ø60/100	0KITATCO00	Accessories supplied as standard		
	Splitter kit Ø80+80	0KITSOP08		Ambient temperature probe	
	Electrical kit for zone management with external probe	0KITZONE05		hot water storage tank temperature probe 3m	

ITACA KRB supplied with ambient temperature probe has a room heating seasonal efficiency of: 93% for model 12; 95% for model 24; 95% for model 28; 96% for model 32



How to increase energy efficiency?

Discover the most suitable solution

Seasonal energy efficiency of ambient heating (η_s)						
Regulation device		Code	KRB 12	KRB 24	KRB 28	KRB 32
Option 1	Boiler + external probe (ambient temperature probe is not supplied)	0SONDAES01	92%	94%	94%	95%
Option 2	Boiler + external probe (ambient temperature probe is supplied)	0SONDAES01	94%	96%	96%	97%
Option 3	Boiler + remote control (ambient temperature probe is not supplied)	0CREMOTO04	93%	95%	95%	96%
Option 4	Boiler + remote control + external probe (ambient temperature probe is not supplied)	0CREMOTO04	94%	96%	96%	97%
		0SONDAES01	94%	96%	96%	97%

ITACA KB

WALL-HUNG CONDENSING BOILER WITH AN INTEGRATED WATER TANK FOR THE PRODUCTION OF DHW



Available in the following models:



- ▶ Ambient temperature probe supplied as standard
- ▶ Modulation ratio: 1:9
- ▶ Thermally-insulated 45-litre stainless steel hot water storage tank
- ▶ hot water storage tank heating setting
- ▶ Management of one heating zone with ambient temperature probe and two zones with zone kit
- ▶ Multifunction relay for connection to systems with zone valves or to solar plant or to remote alarm signal
- ▶ Heating expansion vessel - 10 litres
- › Thermosetting polymer-covered stainless steel heat exchanger
- › Compatible with SPOT smart thermostat
- › Thermoregulation with external probe (optional)
- › Anti-legionella function for hot water storage tank
- › Prearranged for connection to a recirculation system
- › High-efficiency modulating circulation pump with built-in air purging device
- › Automatic by-pass



TOUCH SCREEN INTERFACE

- ▶ Modulation thermostat with ambient probe
- ▶ Day/night temperature level selection
- ▶ Weekly programming
- ▶ Timer and ambient temperature setting
- ▶ Heater DHW "comfort" function enabling

The TOUCH SCREEN interface ITACA KB combined with the ambient temperature probe supplied is a class V adjustment system.

Model	Gas type	Code	Heat input		Energy efficiency class		W x H x D	Gross weight
			Nominal (Qn) kW	Nominal DHW kW	Room heating	Heating DHW	mm	kg
KB 24	NATURAL GAS	KITXX2KB24	23,7	27,3	A	A XL	580x861x412	74,0
	PROPANE	KITXX6KB24						
KB 32	NATURAL GAS	KITXX2KB32	30,4	34,5	A	A XL	580x861x412	79,0
	PROPANE	KITXX6KB32						

DIMENSIONS AND CONNECTION CENTRE DISTANCES

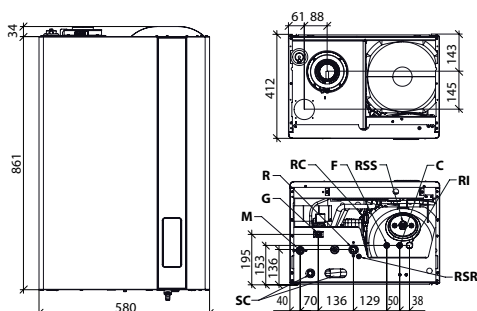

- | | | | |
|-----------|-------------------------|------------|------------------------------------|
| M | CH system flow (3/4") | RSS | DHW drain cock |
| G | Gas inlet (1/2") | C | DHW outlet (1 1/2") |
| R | CH system return (3/4") | RI | Recirculation inlet (1/2") |
| RC | Filler tap | RSR | CH discharge tap |
| F | Cold water inlet (1/2") | SC | Condensate drain and safety valves |



Technical data	um	KB 24	KB 32
Rated output (Pn)	kW	23	29
Seasonal energy efficiency of ambient heating (η_s)	%	92	93
Seasonal energy efficiency of ambient heating (η_s) (Boiler + ambient temperature probe)	%	95	96
Water heating energy efficiency (η_{wh})	%	82	80
Nominal heat input (Qn)	kW	23,7	30,4
Nominal heat output (80-60°C) (Pn)	kW	23,0	29,4
Heat output (50-30°C)	kW	25,0	32,3
Reduced heat input (Qr)	kW	3,0	4,2
Useful efficiency at nominal input (80-60°C)	%	96,8	96,2
Useful efficiency at nominal input (50-30°C)	%	105,6	106,2
Useful efficiency at 30% (30°C return)	%	107,4	108,3
Heating expansion vessel capacity	l	10	10
DHW nominal heat input	kW	27,3	34,5
Specific DHW flow $\Delta T=30K$	l/min	16,2	19,5
NOx emission class	-	6	6
Electric protection rating	IP	IPX4D	IPX4D

For other technical specifications, see from page 67 - Maximum length of flue gas venting, see page 90

Item	Description	Code	Item	Description	Code
	Coaxial kit \varnothing 60/100 length 75cm	0CONDASP00		Recirculation kit	0KRIRC02
	Remote control, ErP V class (118x85x32 mm)	0CREMOTO04		Tap kit with filter KR-KB-RT	0KITRUBI04
	Thermostat starter kit + Spot gateway	0SPOTAPP01		Magnetic dirt separator filter	0AFILDEF00
	Zone expansion for Spot thermostat	0EXPSPOT01	For other accessories, see from page 89		
	Splitter kit \varnothing 80+80	0KITSDOP08	Accessories supplied as standard		
	Electrical kit for zone management with external probe	0KITZONE05		Ambient temperature probe	
	External probe (60x45x31 mm)	0SONDAES01			

ITACA KB supplied with ambient temperature probe has a room heating seasonal efficiency of: 95% for model 24; 96% for model 32



How to increase energy efficiency?

Discover the most suitable solution

Seasonal energy efficiency of ambient heating (η_s)				
Regulation device		Code	KB 24	KB 32
Option 1	Boiler + external probe (ambient temperature probe is not supplied)	0SONDAES01	94%	95%
Option 2	Boiler + external probe (ambient temperature probe is supplied)	0SONDAES01	96%	97%
Option 3	Boiler + remote control (ambient temperature probe is not supplied)	0CREMOTO04	95%	96%
Option 4	Boiler + remote control + external probe (ambient temperature probe is not supplied)	0CREMOTO04	96%	97%
		0SONDAES01	96%	97%

FORMENTERA KC

WALL-HUNG CONDENSING BOILER WITH INSTANTANEOUS PRODUCTION OF DHW



- ▶ **Modulation ratio: 1:9**
- ▶ **High-efficiency modulating circulation pump with built-in air purging device**
- ▶ **Multifunction relay for connection to systems with zone valves or to solar plant or to remote alarm signal**
- ▶ **Controls to manage two different types of solar thermal systems fitted as standard**
- ▶ **High domestic hot water production, more power during DHW operation (18 - 28 - 30 - 35 kW)**
- ▶ **Stainless steel 26-plate DHW heat exchanger**
- ▶ **Heating expansion vessel - 10 litres**
-) Compatible with SPOT smart thermostat
-) Thermosetting polymer-covered stainless steel heat exchanger
-) Freeze protection function for heating and hot water storage tank
-) Thermoregulation with external probe (optional)
-) Automatic by-pass



TOUCH SCREEN INTERFACE

- ▶ DHW and heating temperature setting
- ▶ Operating mode setting
- ▶ Solar thermal systems status display

Available in the following models:



Model	Gas type	Code	Heat input		Energy efficiency class		W x H x D	Gross weight
			Nominal (Qn) kW	Nominal DHW kW	Room heating	Heating DHW	mm	kg
KC 12	NATURAL GAS	KFOXX2KC12	12,0	18,0	A	A M	420x750x315	36,5
	PROPANE	KFOXX6KC12						
KC 24	NATURAL GAS	KFOXX2KC24	23,7	27,3	A	A XL	420x750x315	37,5
	PROPANE	KFOXX6KC24						
KC 28	NATURAL GAS	KFOXX2KC28	26,4	30,4	A	A XL	420x750x315	39,0
	PROPANE	KFOXX6KC28						
KC 32	NATURAL GAS	KFOXX2KC32	30,4	34,5	A	A XXL	420x750x315	40,5
	PROPANE	KFOXX6KC32						

DIMENSIONS AND CONNECTION CENTRE DISTANCES

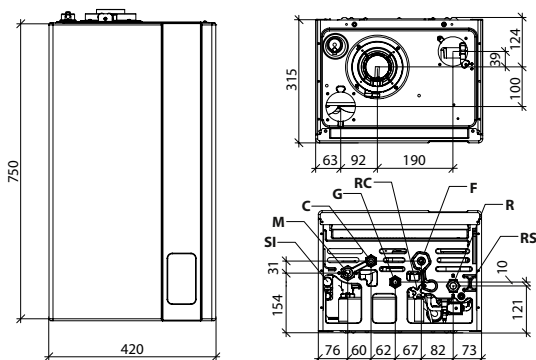

- SI Trap inspection cap
- M CH system flow (3/4")
- C DHW outlet (1 1/2")
- G Gas inlet (1/2")

- RC Filler tap
- F Cold water inlet (1/2")
- R CH system return (3/4")
- RS Discharge tap





Technical data	um	KC 12	KC 24	KC 28	KC 32
Rated output (Pn)	kW	12	23	26	29
Seasonal energy efficiency of ambient heating (η_s)	%	90	92	92	93
Water heating energy efficiency (η_{wh})	%	77	85	86	87
Nominal heat input (Qn)	kW	12,0	23,7	26,4	30,4
Nominal heat output (80-60°C) (Pn)	kW	11,7	23,0	25,5	29,4
Heat output (50-30°C)	kW	12,6	25,0	28,0	32,3
Reduced heat input (Qr)	kW	2,0	3,0	3,3	4,2
Useful efficiency at nominal input (80-60°C)	%	97,1	96,8	96,7	96,8
Useful efficiency at nominal input (50-30°C)	%	105,1	105,6	106,0	106,2
Useful efficiency at 30% (30°C return)	%	106,0	107,4	107,4	108,3
Heating expansion vessel capacity	l	10	10	10	10
DHW nominal heat input	kW	18,0	27,3	30,4	34,5
Specific DHW flow $\Delta T=30K$	l/min	8,8	13,4	15,5	16,2
NOx emission class	-	6	6	6	6
Electric protection rating	IP	IPX5D	IPX5D	IPX5D	IPX5D

For other technical specifications, see from page 68 - Maximum length of flue gas venting, see page 90

Item	Description	Code	Item	Description	Code
	Coaxial kit \varnothing 60/100 length 75cm	0CONDASP00		External probe (60x45x31 mm)	0SONDAES01
	Remote control, ErP V class (118x85x32 mm)	0CREMOTO04		Magnetic dirt separator filter	0AFILDEF00
	Thermostat starter kit + Spot gateway	0SPOTAPP01		Kit for connection to solar plant	0KITSOLC07
	Zone expansion for Spot thermostat	0EXSPOT01		Tap kit with filter KC-KRB-CT-RBT	0KITRUBI05
	Coaxial fitting kit \varnothing 60/100	0KITATCO00		Electric kit for complex solar plant management	0KITSOLC08
	Splitter kit \varnothing 80+80	0KITSDOP08	For other accessories, see from page 89		
	Electrical kit for zone management with external probe	0KITZONE05			



How to increase energy efficiency?

Discover the most suitable solution

Seasonal energy efficiency of ambient heating (η_s)						
Regulation device		Code	KC 12	KC 24	KC 28	KC 32
Option 1	Boiler + external probe	0SONDAES01	92%	94%	94%	95%
Option 2	Boiler + remote control	0CREMOTO04	93%	95%	95%	96%
Option 3	Boiler+ remote control + external probe	0SONDAES01	94%	96%	96%	97%
		0CREMOTO04				

FORMENTERA KR

WALL-HUNG CONDENSING BOILER CH ONLY
CONNECTION TO AN EXTERNAL HOT WATER STORAGE TANK (OPTIONAL) WITH
EXTERNAL 3-WAY VALVE (OPTIONAL)



- ▶ **Modulation ratio: 1:9**
- ▶ **High-efficiency modulating circulation pump with built-in air purging device**
- ▶ **Multifunction relay for connection to systems with zone valves or to solar plant or to remote alarm signal**
- ▶ **Standard management of one type of solar thermal system**
- ▶ **Heating expansion vessel - 10 litres**
 -) Compatible with SPOT smart thermostat
 -) Thermosetting polymer-covered stainless steel heat exchanger
 -) Anti-legionella function for hot water storage tank
 -) Automatic by-pass
 -) Thermoregulation with external probe (optional)



TOUCH SCREEN INTERFACE

- ▶ DHW and heating temperature setting
- ▶ Operating mode setting
- ▶ Solar thermal systems status display

Available in the following models:



Model	Gas type	Code	Heat input		Energy efficiency class	W x H x D	Gross weight
			Nominal (Qn) kW	Nominal DHW kW			
KR 12	NATURAL GAS	KFOXX2KR12	12,0	18,0 (*)	A	420x750x315	34,0
	PROPANE	KFOXX6KR12					
KR 24	NATURAL GAS	KFOXX2KR24	23,7	27,3 (*)	A	420x750x315	36,0
	PROPANE	KFOXX6KR24					
KR 28	NATURAL GAS	KFOXX2KR28	26,4	30,4 (*)	A	420x750x315	37,5
	PROPANE	KFOXX6KR28					
KR 32	NATURAL GAS	KFOXX2KR32	30,4	34,5 (*)	A	420x750x315	39,0
	PROPANE	KFOXX6KR32					

(*) with optional hot water storage tank.

DIMENSIONS AND CONNECTION CENTRE DISTANCES

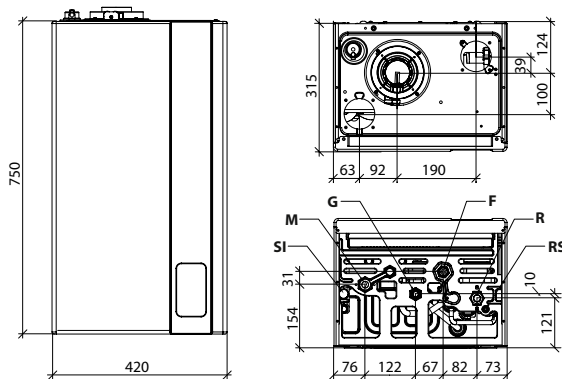

SI Trap inspection cap
M CH system flow (3/4")
G Gas inlet (1/2")

F Cold water inlet (1/2")
R CH system return (3/4")
RS Discharge tap





Technical data	um	KR 12	KR 24	KR 28	KR 32
Rated output (Pn)	kW	12	23	26	29
Seasonal energy efficiency of ambient heating (η_s)	%	90	92	92	93
Nominal heat input (Qn)	kW	12,0	23,7	26,4	30,4
Nominal heat output (80-60°C) (Pn)	kW	11,7	23,0	25,5	29,4
Heat output (50-30°C)	kW	12,6	25,0	28,0	32,3
Reduced heat input (Qr)	kW	2,0	3,0	3,3	4,2
Useful efficiency at nominal input (80-60°C)	%	97,1	96,8	96,7	96,8
Useful efficiency at nominal input (50-30°C)	%	105,1	105,6	106,0	106,2
Useful efficiency at 30% (30°C return)	%	106,0	107,4	107,4	108,3
Heating expansion vessel capacity	l	10	10	10	10
DHW nominal heat input	kW	18,0 (*)	27,3 (*)	30,4 (*)	34,5 (*)
NOx emission class	-	6	6	6	6
Electric protection rating	IP	IPX5D	IPX5D	IPX5D	IPX5D

(*) with optional hot water storage tank.

For other technical specifications, see from page 69 - Maximum length of flue gas venting, see page 90

Item	Description	Code	Item	Description	Code
	Coaxial kit Ø 60/100 length 75cm	0CONDASP00		Electrical kit for zone management with external probe	0KITZONE05
	Remote control, ErP V class (118x85x32 mm)	0CREMOTO04		External probe (60x45x31 mm)	0SONDAES01
	Thermostat starter kit + Spot gateway	0SPOTAPP01		hot water storage tank temperature probe 3m	0KITSOND00
	Zone expansion for Spot thermostat	0EXSPOT01		Magnetic dirt separator filter	0AFILDEF00
	Coaxial fitting kit Ø60/100	0KITATCO00		Tap kit with filter KR-KB-RT	0KITRUBI04
	Splitter kit Ø80+80	0KITSDOP08		Electric kit for complex solar plant management	0KITSOLC08

For other accessories, see from page 89



How to increase energy efficiency?

Discover the most suitable solution

Seasonal energy efficiency of ambient heating (η_s)						
Regulation device		Code	KR 12	KR 24	KR 28	KR 32
Option 1	Boiler + external probe	0SONDAES01	92%	94%	94%	95%
Option 2	Boiler + remote control	0CREMOTO04	93%	95%	95%	96%
Option 3	Boiler+ remote control + external probe	0SONDAES01	94%	96%	96%	97%
		0CREMOTO04				

FORMENTERA KRB

WALL-HUNG CONDENSING BOILER, CH ONLY, WITH INTEGRATED 3-WAY VALVE CONNECTION TO AN EXTERNAL HOT WATER STORAGE TANK (OPTIONAL)



- ▶ **Modulation ratio: 1:9**
- ▶ **Multifunction relay for connection to systems with zone valves or to solar plant or to remote alarm signal**
- ▶ **High-efficiency modulating circulation pump with built-in air purging device**
- ▶ **Standard management of one type of solar thermal system**
- ▶ **Thermoregulation with external probe (optional)**
- ▶ **Integrated 3-way deviating valve**
- ▶ **Heating expansion vessel - 10 litres**
- ▶ Compatible with SPOT smart thermostat
- ▶ Thermosetting polymer-covered stainless steel heat exchanger
- ▶ CH water flow rate electronic control
- ▶ Freeze protection function for heating and hot water storage tank
- ▶ Automatic by-pass



TOUCH SCREEN INTERFACE

- ▶ DHW and heating temperature setting
- ▶ Operating mode setting
- ▶ Solar thermal systems status display

Available in the following models:



Model	Gas type	Code	Heat input		Energy efficiency class	W x H x D mm	Gross weight kg
			Nominal (Qn) kW	Nominal DHW kW			
KRB 12	NATURAL GAS	KFOXX2KU12	12,0	18,0 (*)	A	420x750x315	35,5
	PROPANE	KFOXX6KU12					
KRB 24	NATURAL GAS	KFOXX2KU24	23,7	27,3 (*)	A	420x750x315	37,0
	PROPANE	KFOXX6KU24					
KRB 28	NATURAL GAS	KFOXX2KU28	26,4	30,4 (*)	A	420x750x315	38,0
	PROPANE	KFOXX6KU28					
KRB 32	NATURAL GAS	KFOXX2KU32	30,4	34,5 (*)	A	420x750x315	39,0
	PROPANE	KFOXX6KU32					

(*) with optional hot water storage tank.

DIMENSIONS AND CONNECTION CENTRE DISTANCES

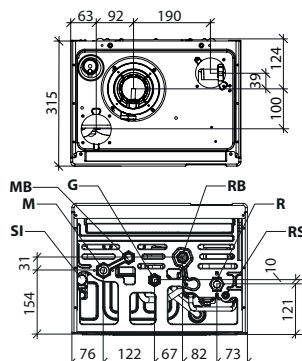
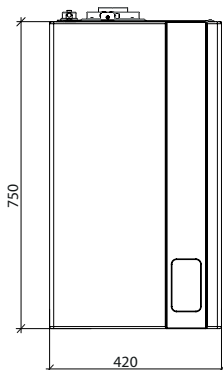

- SI** Trap inspection cap
- M** CH system flow (3/4")
- MB** Secondary flow to hot water storage tank (1/2")
- G** Gas inlet (1/2")
- RB** Secondary return from hot water storage tank (1/2")
- R** CH system return (3/4")
- RS** Discharge tap



Technical data	um	KRB 12	KRB 24	KRB 28	KRB 32
Rated output (Pn)	kW	12	23	26	29
Seasonal energy efficiency of ambient heating (η_s)	%	90	92	92	93
Nominal heat input (Qn)	kW	12,0	23,7	26,4	30,4
Nominal heat output (80-60°C) (Pn)	kW	11,7	23,0	25,5	29,4
Heat output (50-30°C)	kW	12,6	25,0	28,0	32,3
Reduced heat input (Qr)	kW	2,0	3,0	3,3	4,2
Useful efficiency at nominal input (80-60°C)	%	97,1	96,8	96,7	96,8
Useful efficiency at nominal input (50-30°C)	%	105,1	105,6	106,0	106,2
Useful efficiency at 30% (30°C return)	%	106,0	107,4	107,4	108,3
Heating expansion vessel capacity	l	10	10	10	10
DHW nominal heat input	kW	18,0 (*)	27,3 (*)	30,4 (*)	34,5 (*)
NOx emission class	-	6	6	6	6
Electric protection rating	IP	IPX5D	IPX5D	IPX5D	IPX5D

(*) with optional hot water storage tank.

For other technical specifications, see from page 70 - Maximum length of flue gas venting, see page 90

Item	Description	Code	Item	Description	Code
	Coaxial kit Ø 60/100 length 75cm	0CONDASP00		Electrical kit for zone management with external probe	OKITZONE05
	Remote control, ErP V class (118x85x32 mm)	0CREMOTO04		Tap kit with filter KC-KRB-CT-RBT	OKITRUBI05
	Thermostat starter kit + Spot gateway	0SPOTAPP01		Magnetic dirt separator filter	0AFILDEF00
	Zone expansion for Spot thermostat	0EXSPOT01		Temperature probe for solar plants	PSPTMILL00
	Splitter kit Ø80+80	0KITSDOP08	For other accessories, see from page 89		
	Coaxial fitting kit Ø60/100	0KITATCO00	Accessories supplied as standard		
	External probe (60x45x31 mm)	0SONDAES01		hot water storage tank temperature probe 3m	



How to increase energy efficiency?

Discover the most suitable solution

Seasonal energy efficiency of ambient heating (η_s)						
Regulation device		Code	KRB 12	KRB 24	KRB 28	KRB 32
Option 1	Boiler + external probe	0SONDAES01	92%	94%	94%	95%
Option 2	Boiler + remote control	0CREMOTO04	93%	95%	95%	96%
Option 3	Boiler+ remote control + external probe	0SONDAES01	94%	96%	96%	97%
		0CREMOTO04				

ANTEA NEXT KC

WALL-HUNG CONDENSING BOILER WITH INSTANTANEOUS PRODUCTION OF DHW



- ▶ **CeramiXSteel combustion unit:**
- ▶ **HIGH DURABILITY EXCHANGER:** thanks to the all-stainless steel single coil and large passage section, it avoids clogging and guarantees high performance over time
- ▶ **CERAMIC QUALITY:** high-performance ceramic burner allowing a wider modulation range
- ▶ **ADVANCED ELECTRONICS:** intuitive and functional with large colour display
- ▶ **EASY INSTALLATION:** simple and practical fixing and maintenance
- ▶ **ALTERNATIVE SOURCES CONFIGURATION:** through an intelligent algorithm it acts as a control unit for alternative energy sources
- ▶ **SMART CONNECTION:** can be connected to bms (integrated Modbus) and IOT building automation systems
- ▶ **COMBINED COMFORT:** thanks to the room temperature probe, the functioning is adapted to the room temperature without the use of a thermostat
- ▶ **CUSTOMIZABLE OPERATING:** weekly programmable
- ▶ **SOLAR PRO FUNCTION:** enables the management of a solar thermal system
- ▶ **HIGH ELECTRICAL INSULATION:** thanks to the IPX5D electrical insulation rating it can be installed outdoors in partially protected locations
- ▶ **HIGH EFFICIENCY:** thanks to the 1:9 modulation ratio, high performance is guaranteed



USER INTERFACE

- ▶ Day/night temperature level selection
- ▶ Timer and ambient temperature setting

Available in the following models:



Model	Gas type	Code	Heat input		Energy efficiency class		W x H x D	Gross weight
			Nominal (Qn) kW	Nominal DHW kW	Room heating	Heating DHW	mm	kg
KC 26	NATURAL GAS	KAGXX2KC26	23,7	27,3	A	A XL	400x750x315	30,5
	PROPANE	KAGXX6KC26						
KC 30	NATURAL GAS	KAGXX2KC30	26,7	30,4	A	A XL	400x750x315	32,5
	PROPANE	KAGXX6KC30						
KC 35	NATURAL GAS	KAGXX2KC35	30,4	34,5	A	A XL	400x750x315	33,0
	PROPANE	KAGXX6KC35						

Included in the price: Paper installation template, aspiration closing plugs.

DIMENSIONS AND CONNECTION CENTRE DISTANCES

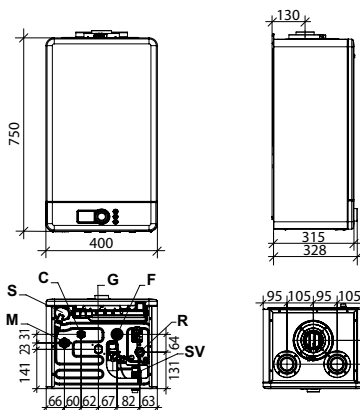

- S Trap inspection cap
- M CH system flow (3/4")
- C DHW outlet (1/2")
- SV 3-bar safety valve drain
- G Gas inlet (3/4")
- F Cold water inlet (1/2")
- R CH system return (3/4")





Technical data	um	KC 26	KC 30	KC 35
Rated output (Pn)	kW	23	26	30
Seasonal energy efficiency of ambient heating (η_s)	%	92	92	91
Water heating energy efficiency (η_{wh})	%	84	84	85
Nominal heat input (Qn)	kW	23,7	26,7	30,4
Nominal heat output (80-60°C) (Pn)	kW	23,1	26,0	29,6
Heat output (50-30°C)	kW	25,0	28,1	32,2
Reduced heat input (Qr)	kW	3,0	3,3	4,2
Useful efficiency at nominal input (80-60°C)	%	97,3	97,3	97,3
Useful efficiency at nominal input (50-30°C)	%	105,5	105,4	105,9
Useful efficiency at 30% (30°C return)	%	108,4	108,0	107,8
Heating expansion vessel capacity	l	9	9	9
DHW nominal heat input	kW	27,3	30,4	34,5
Specific DHW flow $\Delta T=30K$	l/min	13,4	15,0	17,3
NOx emission class	-	6	6	6
Electric protection rating	IP	IPX5D	IPX5D	IPX5D

For other technical specifications, see from page 71 - Maximum length of flue gas venting, see page 90

Item	Description	Code	Item	Description	Code
	Coaxial kit \varnothing 60/100 length 75cm	0CONDASP00		Ambient temperature probe	OKITSAMB00
	Remote control, ErP V class (118x85x32 mm)	0CREMOTO04		External probe (60x45x31 mm)	0SONDAES01
	Thermostat starter kit + Spot gateway	0SPOTAPP01		Basic solar kit	OKITSOLC09
	Zone expansion for Spot thermostat	0EXPSPOT01		Basic hydraulic kit Next boilers	OKITIDBA30
	Coaxial fitting kit \varnothing 60/100	0KITATCO00		Covering pipes and boiler taps Next (*)	0COPETUB08
	Splitter kit \varnothing 80+80	0KITSDOP08		NTC probe kit for 10k beta 3977 circuit breaker (*)	OKITSOND01
	Magnetic dirt separator filter	0AFILDEF00		PT 1000 probe kit with ring connection (*)	OKITSOPT00

For other accessories, see from page 89

(*) Items normally not in stock, minimum stock availability time 8 weeks.



How to increase energy efficiency?

Discover the most suitable solution

Seasonal energy efficiency of ambient heating (η_s)					
Regulation device	Code	KC 26	KC 30	KC 35	
Option 1 Boiler + external probe	0SONDAES01	94%	94%	93%	
Option 2 Boiler + room temperature probe	OKITSAMB00	95%	95%	94%	
Option 3 Boiler + external probe + room temperature probe	OKITSAMB00	96%	96%	95%	
	0SONDAES01				
Option 4 Boiler + remote control	0CREMOTO04	95%	95%	94%	
Option 5 Boiler+ remote control + external probe	0CREMOTO04	96%	96%	95%	

ANTEA NEXT KR

WALL-HUNG CONDENSING BOILER CH ONLY
CONNECTION TO AN EXTERNAL HOT WATER STORAGE TANK
(OPTIONAL) WITH EXTERNAL 3-WAY VALVE (OPTIONAL)

ENERGY RELATED PRODUCTS



- ▶ **CeramiXSteel combustion unit:**
- ▶ **HIGH DURABILITY EXCHANGER:** thanks to the all-stainless steel single coil and large passage section, it avoids clogging and guarantees high performance over time
- ▶ **CERAMIC QUALITY:** high-performance ceramic burner allowing a wider modulation range
- ▶ **ADVANCED ELECTRONICS:** intuitive and functional with large colour display
- ▶ **EASY INSTALLATION:** simple and practical fixing and maintenance
- ▶ **ALTERNATIVE SOURCES CONFIGURATION:** through an intelligent algorithm it acts as a control unit for alternative energy sources
- ▶ **SMART CONNECTION:** can be connected to bms (integrated Modbus) and IOT building automation systems
-) **COMBINED COMFORT:** thanks to the room temperature probe, the functioning is adapted to the room temperature without the use of a thermostat
-) **SOLAR PRO FUNCTION:** enables the management of a solar thermal system
-) **HIGH ELECTRICAL INSULATION:** thanks to the IPX5D electrical insulation rating it can be installed outdoors in partially protected locations
-) **HIGH EFFICIENCY:** thanks to the 1:9 modulation ratio, high performance is guaranteed
-) **CUSTOMIZABLE OPERATING:** weekly programmable

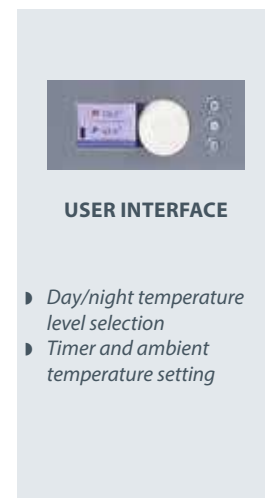

Available in the following models:



Model	Gas type	Code	Heat input		Energy efficiency class	W x H x D	Gross weight
			Nominal (Qn) kW	Nominal DHW kW	Room heating	mm	kg
KR 12	NATURAL GAS	KAGXX2KR12	12,0	18,0 (*)	A	400x750x315	29,5
	PROPANE	KAGXX6KR12					
KR 24	NATURAL GAS	KAGXX2KR24	23,7	27,3 (*)	A	400x750x315	29,5
	PROPANE	KAGXX6KR24					
KR 28	NATURAL GAS	KAGXX2KR28	26,7	30,4 (*)	A	400x750x315	31,5
	PROPANE	KAGXX6KR28					
KR 32	NATURAL GAS	KAGXX2KR32	30,4	34,5 (*)	A	400x750x315	32,0
	PROPANE	KAGXX6KR32					

(*) with optional hot water storage tank.

Included in the price: Paper installation template, aspiration closing plugs.

DIMENSIONS AND CONNECTION CENTRE DISTANCES

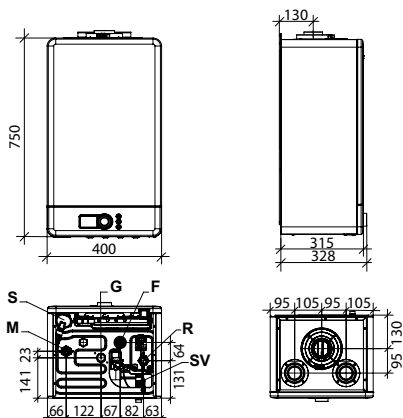

S Trap inspection cap
M CH system flow (3/4")
SV 3-bar safety valve drain

G Gas inlet (3/4")
F Cold water inlet (1/2")
R CH system return (3/4")





Technical data	um	KR 12	KR 24	KR 28	KR 32
Rated output (Pn)	kW	12	23	26	30
Seasonal energy efficiency of ambient heating (η_s)	%	92	92	92	91
Nominal heat input (Qn)	kW	12,0	23,7	26,7	30,4
Nominal heat output (80-60°C) (Pn)	kW	11,8	23,1	26,0	29,6
Heat output (50-30°C)	kW	12,9	25,0	28,1	32,2
Reduced heat input (Qr)	kW	2,0	3,0	3,3	4,2
Useful efficiency at nominal input (80-60°C)	%	98,0	97,3	97,3	97,3
Useful efficiency at nominal input (50-30°C)	%	107,5	105,5	105,4	105,9
Useful efficiency at 30% (30°C return)	%	108,3	108,4	108,0	107,8
Heating expansion vessel capacity	l	9	9	9	9
DHW nominal heat input	kW	18,0 (*)	27,3 (*)	30,4 (*)	34,5 (*)
NOx emission class	-	6	6	6	6
Electric protection rating	IP	IPX5D	IPX5D	IPX5D	IPX5D

For other technical specifications, see from page 72 - Maximum length of flue gas venting, see page 90 (*) with optional hot water storage tank.

Item	Description	Code	Item	Description	Code
	Coaxial kit Ø 60/100 length 75cm	0CONDASP00		Ambient temperature probe	OKITSAMB00
	Remote control, ErP V class (118x85x32 mm)	0CREMOTO04		External probe (60x45x31 mm)	0SONDAES01
	Thermostat starter kit + Spot gateway	0SPOTAPP01		Basic hydraulic kit Next boilers	OKITIDBA30
	Zone expansion for Spot thermostat	0EXSPOT01		Covering pipes and boiler taps Next (*)	0COPETUB08
	Coaxial fitting kit Ø60/100	OKITATCO00		NTC probe kit for 10k beta 3977 circuit breaker (*)	OKITSOND01
	Splitter kit Ø80+80	OKITSDOP08		PT 1000 probe kit with ring connection (*)	OKITSOPT00
	Magnetic dirt separator filter	0AFILDEF00	For other accessories, see from page 89		

(*) Items normally not in stock, minimum stock availability time 8 weeks.



How to increase energy efficiency?

Discover the most suitable solution

Seasonal energy efficiency of ambient heating (η_s)						
Regulation device	Code	KR 12	KR 24	KR 28	KR 32	
Option 1 Boiler + external probe	0SONDAES01	94%	94%	94%	93%	
Option 2 Boiler + room temperature probe	OKITSAMB00	95%	95%	95%	94%	
Option 3 Boiler + external probe + room temperature probe	OKITSAMB00	96%	96%	96%	95%	
	0SONDAES01					
Option 4 Boiler + remote control	0CREMOTO04	95%	95%	95%	94%	
Option 5 Boiler+ remote control + external probe	0CREMOTO04	96%	96%	96%	95%	

ANTEA NEXT KRB

WALL-HUNG CONDENSING BOILER, CH ONLY, WITH INTEGRATED 3-WAY VALVE
CONNECTION TO AN EXTERNAL HOT WATER STORAGE TANK (OPTIONAL)

ENERGY RELATED PRODUCTS



- ▶ **CeramiXSteel combustion unit:**
- ▶ **HIGH DURABILITY EXCHANGER:** thanks to the all-stainless steel single coil and large passage section, it avoids clogging and guarantees high performance over time
- ▶ **CERAMIC QUALITY:** high-performance ceramic burner allowing a wider modulation range
- ▶ **ADVANCED ELECTRONICS:** intuitive and functional with large colour display
- ▶ **EASY INSTALLATION:** simple and practical fixing and maintenance
- ▶ **ALTERNATIVE SOURCES CONFIGURATION:** through an intelligent algorithm it acts as a control unit for alternative energy sources
- ▶ **SMART CONNECTION:** can be connected to bms (integrated Modbus) and IOT building automation systems
- ▶ **COMBINED COMFORT:** thanks to the room temperature probe, the functioning is adapted to the room temperature without the use of a thermostat
- ▶ **SOLAR PRO FUNCTION:** enables the management of a solar thermal system
- ▶ **HIGH ELECTRICAL INSULATION:** thanks to the IPX5D electrical insulation rating it can be installed outdoors in partially protected locations
- ▶ **HIGH EFFICIENCY:** thanks to the 1:9 modulation ratio, high performance is guaranteed
- ▶ **CUSTOMIZABLE OPERATING:** weekly programmable

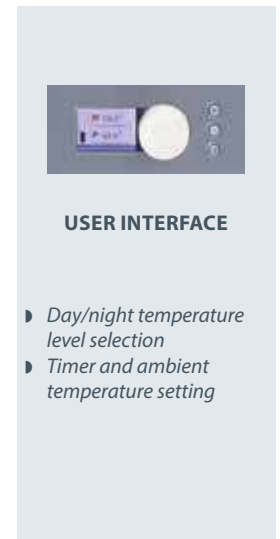

Available in the following models:



Model	Gas type	Code	Heat input		Energy efficiency class	W x H x D	Gross weight
			Nominal (Qn) kW	Nominal DHW kW	Room heating	mm	kg
KRB 12	NATURAL GAS	KAGXX2KU12	12,0	18,0 (*)	A	400x750x315	29,5
	PROPANE	KAGXX6KU12					
KRB 24	NATURAL GAS	KAGXX2KU24	23,7	27,3 (*)	A	400x750x315	29,5
	PROPANE	KAGXX6KU24					
KRB 28	NATURAL GAS	KAGXX2KU28	26,7	30,4 (*)	A	400x750x315	31,5
	PROPANE	KAGXX6KU28					
KRB 32	NATURAL GAS	KAGXX2KU32	30,4	34,5 (*)	A	400x750x315	32,0
	PROPANE	KAGXX6KU32					

(*) with optional hot water storage tank.

Included in the price: Paper installation template, aspiration closing plugs.

DIMENSIONS AND CONNECTION CENTRE DISTANCES

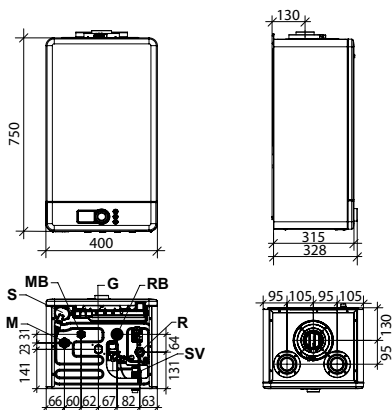

- S** Trap inspection cap
- M** CH system flow (3/4")
- MB** Secondary flow to storage tank (1/2")
- SV** 3-bar safety valve drain
- G** Gas inlet (3/4")
- RB** Secondary return from hot water storage tank (1/2")
- R** CH system return (3/4")





Technical data	um	KRB 12	KRB 24	KRB 28	KRB 32
Rated output (Pn)	kW	12	23	26	30
Seasonal energy efficiency of ambient heating (η_s)	%	92	92	92	91
Nominal heat input (Qn)	kW	12,0	23,7	26,7	30,4
Nominal heat output (80-60°C) (Pn)	kW	11,8	23,1	26,0	29,6
Heat output (50-30°C)	kW	12,9	25,0	28,1	32,2
Reduced heat input (Qr)	kW	2,0	3,0	3,3	4,2
Useful efficiency at nominal input (80-60°C)	%	98,0	97,3	97,3	97,3
Useful efficiency at nominal input (50-30°C)	%	107,5	105,5	105,4	105,9
Useful efficiency at 30% (30°C return)	%	108,3	108,4	108,0	107,8
Heating expansion vessel capacity	l	9	9	9	9
DHW nominal heat input	kW	18,0 (*)	27,3 (*)	30,4 (*)	34,5 (*)
NOx emission class	-	6	6	6	6
Electric protection rating	IP	IPX5D	IPX5D	IPX5D	IPX5D

For other technical specifications, see from page 73 - Maximum length of flue gas venting, see page 90 (*) with optional hot water storage tank.

Item	Description	Code	Item	Description	Code
	Coaxial kit Ø 60/100 length 75cm	0CONDASP00		External probe (60x45x31 mm)	0SONDAES01
	Remote control, ErP V class (118x85x32 mm)	0CREMOTO04		Basic hydraulic kit Next boilers	0KITIDBA30
	Thermostat starter kit + Spot gateway	0SPOTAPP01		Covering pipes and boiler taps Next (*)	0COPETUB08
	Zone expansion for Spot thermostat	0EXSPOT01		NTC probe kit for 10k beta 3977 circuit breaker (*)	0KITSOND01
	Coaxial fitting kit Ø60/100	0KITATCO00		PT 1000 probe kit with ring connection (*)	0KITSOPT00
	Splitter kit Ø80+80	0KITSDOP08	For other accessories, see from page 89		
	Magnetic dirt separator filter	0AFILDEF00	Accessories supplied as standard		
	Ambient temperature probe	0KITSAMB00		hot water storage tank temperature probe 3m	

(*) Items normally not in stock, minimum stock availability time 8 weeks.



How to increase energy efficiency?

Discover the most suitable solution

Seasonal energy efficiency of ambient heating (η_s)						
Regulation device		Code	KRB 12	KRB 24	KRB 28	KRB 32
Option 1	Boiler + external probe	0SONDAES01	94%	94%	94%	93%
Option 2	Boiler + room temperature probe	0KITSAMB00	95%	95%	95%	94%
Option 3	Boiler + external probe + room temperature probe	0KITSAMB00	96%	96%	96%	95%
		0SONDAES01				
Option 4	Boiler + remote control	0CREMOTO04	95%	95%	95%	94%
Option 5	Boiler+ remote control + external probe	0CREMOTO04	96%	96%	96%	95%

ANTEA KC

WALL-HUNG CONDENSING BOILER WITH INSTANTANEOUS PRODUCTION OF DHW



- ▶ **High domestic hot water production, more power during DHW operation (18 - 28 - 30 kW)**
- ▶ **Modulation ratio: 1:9**
- ▶ **Multifunction relay for connection to systems with zone valves or to external pump management or to remote alarm signal**
- ▶ **Heating expansion vessel - 9 litres**
- ▶ **High-efficiency modulating circulation pump with built-in air purging device**
- ▶ **Compact dimension, only 250 mm deep**
-) Compatible with SPOT smart thermostat
-) Management of 2 different kinds of solar thermal system (with additional kit)
-) Thermoregulation with external probe (optional)
-) Thermosetting polymer-covered stainless steel heat exchanger
-) Prearrangement for connection to Remote Control (optional, supplied by the manufacturer)
-) Programmable parameters to adapt the boiler to the installation and alerts history
-) Automatic by-pass

Available in the following models:



Model	Gas type	Code	Heat input		Energy efficiency class		W x H x D mm	Gross weight kg
			Nominal (Qn) kW	Nominal DHW kW	Room heating	Heating DHW		
KC 12	NATURAL GAS	KALXX2KC12	12,0	18,0	A	A M	400x700x250	30,5
	PROPANE	KALXX6KC12						
KC 24	NATURAL GAS	KALXX2KC24	23,7	27,3	A	A XL	400x700x250	32,0
	PROPANE	KALXX6KC24						
KC 28	NATURAL GAS	KALXX2KC28	26,4	30,4	A	A XL	400x700x250	33,5
	PROPANE	KALXX6KC28						

DIMENSIONS AND CONNECTION CENTRE DISTANCES

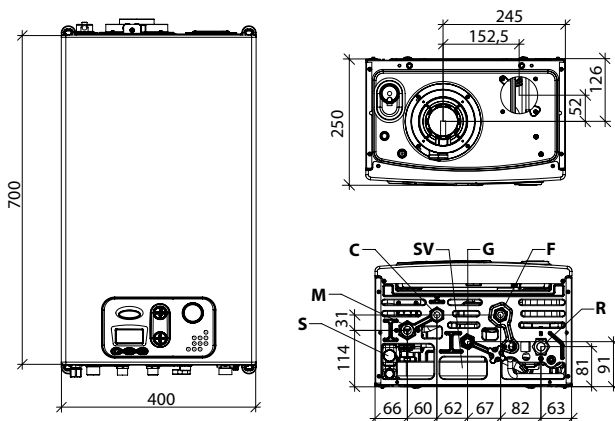

- S** Trap inspection cap
- M** CH system flow (3/4")
- C** DHW outlet (1 1/2")
- SV** 3-bar safety valve drain

- G** Gas inlet (1/2")
- F** Cold water inlet (1/2")
- R** CH system return (3/4")



Technical data	um	KC 12	KC 24	KC 28
Rated output (Pn)	kW	12	23	26
Seasonal energy efficiency of ambient heating (η_s)	%	90	92	92
Water heating energy efficiency (η_{wh})	%	78	84	80
Nominal heat input (Qn)	kW	12,0	23,7	26,4
Nominal heat output (80-60°C) (Pn)	kW	11,7	22,8	25,5
Heat output (50-30°C)	kW	12,6	24,9	28,0
Reduced heat input (Qr)	kW	2,0	3,0	3,3
Useful efficiency at nominal input (80-60°C)	%	97,1	96,3	96,7
Useful efficiency at nominal input (50-30°C)	%	105,1	105,1	105,9
Useful efficiency at 30% (30°C return)	%	106,0	107,2	107,5
Heating expansion vessel capacity	l	9	9	9
DHW nominal heat input	kW	18,0	27,3	30,4
Specific DHW flow $\Delta T=30K$	l/min	8,6	13,4	15,0
NOx emission class	-	6	6	6
Electric protection rating	IP	IPX4D	IPX4D	IPX4D

For other technical specifications, see from page 74 - Maximum length of flue gas venting, see page 90

Item	Description	Code	Item	Description	Code
	Coaxial kit \varnothing 60/100 length 75cm	0CONDASP00		Electric kit for complex solar plant management	0KITSOLC08
	Remote control, ErP V class (118x85x32 mm)	0CREMOTO04		Magnetic dirt separator filter	0AFILDEF00
	Thermostat starter kit + Spot gateway	0SPOTAPP01		Kit for connection to solar plant	0KITSOLC07
	Zone expansion for Spot thermostat	0EXPSPOT01		Tap kit with filter KC-KRB-CT-RBT	0KITRUBI05
	Splitter kit \varnothing 80+80	0KITSDOP08		Coax. adapter kit D.60/100 to D.80/125	0KITADCO00
	Electrical kit for zone management with external probe	0KITZONE05		Compact wall pipe cover - Height 110 mm - Width 400 mm - Depth (upper part) 194 mm - Depth (lower part) 165 mm	0COPETUB00
	External probe (60x45x31 mm)	0SONDAES01	For other accessories, see from page 89		
	Coaxial fitting kit \varnothing 60/100	0KITATCO00			



How to increase energy efficiency?

Discover the most suitable solution

Seasonal energy efficiency of ambient heating (η_s)					
Regulation device	Code	KC 12	KC 24	KC 28	
Option 1	Boiler + external probe	0SONDAES01	92%	94%	94%
Option 2	Boiler + remote control	0CREMOTO04	93%	95%	95%
Option 3	Boiler+ remote control + external probe	0SONDAES01	94%	96%	96%
		0CREMOTO04			

ANTEA KR

WALL-HUNG CONDENSING BOILER CH ONLY
CONNECTION TO AN EXTERNAL HOT WATER STORAGE TANK (OPTIONAL) WITH
EXTERNAL 3-WAY VALVE (OPTIONAL)



- ▶ Multifunction relay for connection to systems with zone valves or to external pump management or to remote alarm signal
- ▶ Modulation ratio: 1:9
- ▶ Heating expansion vessel - 9 litres
- ▶ High-efficiency modulating circulation pump with built-in air purging device
- ▶ Compact dimension, only 250 mm deep
-) Compatible with SPOT smart thermostat
-) Freeze protection function for heating and hot water storage tank
-) Thermoregulation with external probe (optional)
-) Thermosetting polymer-covered stainless steel heat exchanger
-) Prearrangement for connection to Remote Control (optional, supplied by the manufacturer)
-) Programmable parameters to adapt the boiler to the installation and alerts history
-) Automatic by-pass

Available in the following models:



Model	Gas type	Code	Heat input		Energy efficiency class	W x H x D mm	Gross weight kg
			Nominal (Qn) kW	Nominal DHW kW			
KR 12	NATURAL GAS	KALXX2KR12	12,0	18,0 (*)	A	400x700x250	29,5
	PROPANE	KALXX6KR12					
KR 24	NATURAL GAS	KALXX2KR24	23,7	27,3 (*)	A	400x700x250	32,0
	PROPANE	KALXX6KR24					
KR 28	NATURAL GAS	KALXX2KR28	26,4	30,4 (*)	A	400x700x250	31,0
	PROPANE	KALXX6KR28					

(*) with optional hot water storage tank.

DIMENSIONS AND CONNECTION CENTRE DISTANCES

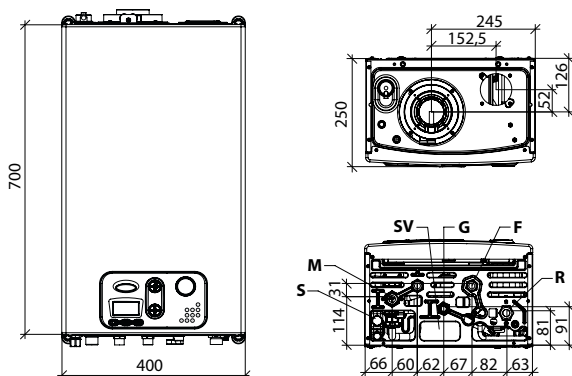

S Trap inspection cap
M CH system flow (3/4")
SV 3-bar safety valve drain

G Gas inlet (1/2")
F Cold water inlet (1/2")
R CH system return (3/4")

Technical data	um	KR 12	KR 24	KR 28
Rated output (Pn)	kW	12	23	26
Seasonal energy efficiency of ambient heating (η_s)	%	90	92	92
Nominal heat input (Qn)	kW	12,0	23,7	26,4
Nominal heat output (80-60°C) (Pn)	kW	11,7	22,8	25,5
Heat output (50-30°C)	kW	12,6	24,9	28,0
Reduced heat input (Qr)	kW	2,0	3,0	3,3
Useful efficiency at nominal input (80-60°C)	%	97,1	96,3	96,7
Useful efficiency at nominal input (50-30°C)	%	105,1	105,1	105,9
Useful efficiency at 30% (30°C return)	%	106,0	107,2	107,5
Heating expansion vessel capacity	l	9	9	9
DHW nominal heat input	kW	18,0 (*)	27,3 (*)	30,4 (*)
NOx emission class	-	6	6	6
Electric protection rating	IP	IPX4D	IPX4D	IPX4D

(*) with optional hot water storage tank.

For other technical specifications, see from page 75 - Maximum length of flue gas venting, see page 90

Item	Description	Code	Item	Description	Code
	Coaxial kit Ø 60/100 length 75cm	0CONDASP00		External probe (60x45x31 mm)	0SONDAES01
	Remote control, ErP V class (118x85x32 mm)	0CREMOTO04		Coaxial fitting kit Ø60/100	0KITATCO00
	Thermostat starter kit + Spot gateway	0SPOTAPP01		Coax. adapter kit D.60/100 to D.80/125	0KITADCO00
	Zone expansion for Spot thermostat	0EXPSPOT01		hot water storage tank temperature probe 3m	0KITSOND00
	Tap kit with filter KR-KB-RT	0KITRUBI04		Magnetic dirt separator filter	0AFILDEF00
	Splitter kit Ø80+80	0KITSDOP08		Compact wall pipe cover - Height 110 mm - Width 400 mm - Depth (upper part) 194 mm - Depth (lower part) 165 mm	0COPETUB00
	Electrical kit for zone management with external probe	0KITZONE05		Starting flange kit for condensing boilers	0KITFLAN00

For other accessories, see from page 89



How to increase energy efficiency?

Discover the most suitable solution

Seasonal energy efficiency of ambient heating (η_s)					
Regulation device		Code	KR 12	KR 24	KR 28
Option 1	Boiler + external probe	0SONDAES01	92%	94%	94%
Option 2	Boiler + remote control	0CREMOTO04	93%	95%	95%
Option 3	Boiler+ remote control + external probe	0SONDAES01	94%	96%	96%
		0CREMOTO04			

ANTEA KRB

WALL-HUNG CONDENSING BOILER, CH ONLY, WITH INTEGRATED 3-WAY VALVE CONNECTION TO AN EXTERNAL HOT WATER STORAGE TANK (OPTIONAL)



- ▶ Multifunction relay for connection to systems with zone valves or to external pump management or to remote alarm signal
- ▶ Modulation ratio: 1:9
- ▶ Heating expansion vessel - 9 litres
- ▶ Integrated 3-way deviating valve
- ▶ High-efficiency modulating circulation pump with built-in air purging device
- ▶ Compact dimension, only 250 mm deep
 -) Compatible with SPOT smart thermostat
 -) Freeze protection function for heating and hot water storage tank
 -) Thermoregulation with external probe (optional)
 -) Thermosetting polymer-covered stainless steel heat exchanger
 -) Prearrangement for connection to Remote Control (optional, supplied by the manufacturer)
 -) Programmable parameters to adapt the boiler to the installation and alerts history
 -) Automatic by-pass

Available in the following models:



Model	Gas type	Code	Heat input		Energy efficiency class	W x H x D	Gross weight
			Nominal (Qn) kW	Nominal DHW kW	Room heating	mm	kg
KRB 12	NATURAL GAS	KALXX2KU12	12,0	18,0 (*)	A	400x700x250	29,5
	PROPANE	KALXX6KU12					
KRB 24	NATURAL GAS	KALXX2KU24	23,7	27,3 (*)	A	400x700x250	31,0
	PROPANE	KALXX6KU24					
KRB 28	NATURAL GAS	KALXX2KU28	26,4	30,4 (*)	A	400x700x250	32,5
	PROPANE	KALXX6KU28					

(*) with optional hot water storage tank.

DIMENSIONS AND CONNECTION CENTRE DISTANCES

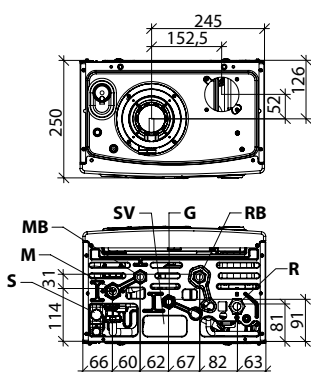
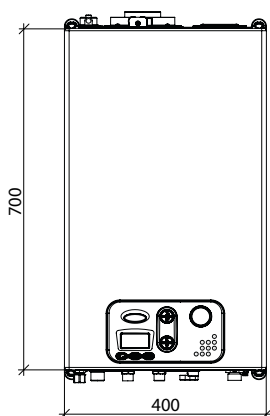

- | | | | |
|-----------|---|-----------|---|
| S | Trap inspection cap | G | Gas inlet (1/2") |
| M | CH system flow (3/4") | RB | Secondary return from hot water storage tank (1/2") |
| MB | Secondary flow to hot water storage tank (1/2") | R | CH system return (3/4") |
| SV | 3-bar safety valve drain | | |

Technical data	um	KRB 12	KRB 24	KRB 28
Rated output (Pn)	kW	12	23	26
Seasonal energy efficiency of ambient heating (η_s)	%	90	92	92
Nominal heat input (Qn)	kW	12,0	23,7	26,4
Nominal heat output (80-60°C) (Pn)	kW	11,7	22,8	25,5
Heat output (50-30°C)	kW	12,6	24,9	28,0
Reduced heat input (Qr)	kW	2,0	3,0	3,3
Useful efficiency at nominal input (80-60°C)	%	97,1	96,3	96,7
Useful efficiency at nominal input (50-30°C)	%	105,1	105,1	105,9
Useful efficiency at 30% (30°C return)	%	106,0	107,2	107,5
Heating expansion vessel capacity	l	9	9	9
DHW nominal heat input	kW	18,0 (*)	27,3 (*)	30,4 (*)
NOx emission class	-	6	6	6
Electric protection rating	IP	IPX4D	IPX4D	IPX4D

(*) with optional hot water storage tank.

For other technical specifications, see from page 76 - Maximum length of flue gas venting, see page 90

Item	Description	Code	Item	Description	Code
	Coaxial kit Ø 60/100 length 75cm	0CONDASP00		Coaxial fitting kit Ø60/100	0KITATCO00
	Remote control, ErP V class (118x85x32 mm)	0CREMOTO04		Coax. adapter kit D.60/100 to D.80/125	0KITADCO00
	Thermostat starter kit + Spot gateway	0SPOTAPP01		Magnetic dirt separator filter	0AFILDEF00
	Zone expansion for Spot thermostat	0EXSPOT01		Electric kit for complex solar plant management	0KITSOLC08
	Tap kit with filter KC-KRB-CT-RBT	0KITRUBI05		Compact wall pipe cover - Height 110 mm - Width 400 mm - Depth (upper part) 194 mm - Depth (lower part) 165 mm	0COPETUB00
	Splitter kit Ø80+80	0KITSDOP08	For other accessories, see from page 89		
	Electrical kit for zone management with external probe	0KITZONE05	Accessories supplied as standard		
	External probe (60x45x31 mm)	0SONDAES01		hot water storage tank temperature probe 3m	



How to increase energy efficiency?

Discover the most suitable solution

Seasonal energy efficiency of ambient heating (η_s)					
Regulation device		Code	KRB 12	KRB 24	KRB 28
Option 1	Boiler + external probe	0SONDAES01	92%	94%	94%
Option 2	Boiler + remote control	0CREMOTO04	93%	95%	95%
Option 3	Boiler+ remote control + external probe	0SONDAES01	94%	96%	96%
		0CREMOTO04			

TENERIFE KC

WALL-HUNG CONDENSING BOILER WITH INSTANTANEOUS PRODUCTION OF DHW



- ▶ **High efficiency stainless steel heat exchanger with single coil and wide passage section**
- ▶ **Heating expansion vessel - 9 litres**
- ▶ **Compact dimension, only 250 mm deep**
- ▶ **Easy to install in pre-existing plants thanks to: central flue vent, wall fixing bracket and double hole for split suction**
- ▶ **Thermoregulation with external probe (optional)**
- ▶ **Backlit LCD user interface with diagnostics**
-) Modulation ratio: 1:5
-) Fully pre-mixed burner
-) High-efficiency circulation pump with built-in air purging device
-) Programmable parameters to adapt the boiler to the installation and alerts history
-) Stainless steel plate DHW heat exchanger
-) Automatic by-pass
-) Compatible with SPOT smart thermostat

Available in the following models:

24

Model	Gas type	Code	Heat input		Energy efficiency class		W x H x D	Gross weight
			Nominal (Qn) kW	Nominal DHW kW	Room heating	Heating DHW	mm	kg
KC 24	NATURAL GAS	KTFXX2KC24	20,0	24,0	A	A XL	400x700x250	29,0
	PROPANE	KTFXX6KC24						

Included in the price: Paper installation template, aspiration closing plugs.

DIMENSIONS AND CONNECTION CENTRE DISTANCES

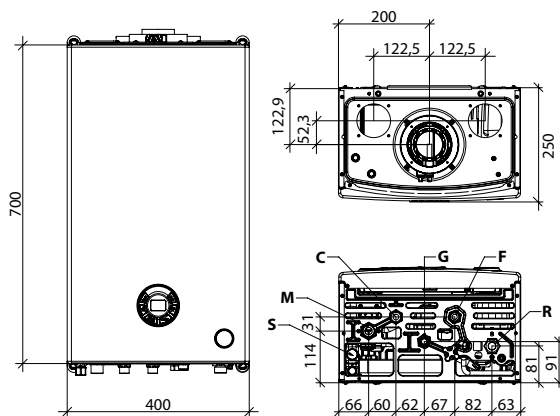

S Condensate drain
M CH system flow (3/4")
C DHW outlet (1 1/2")

G Gas inlet (1/2")
F Cold water inlet (1/2")
R CH system return (3/4")





Technical data	um	KC 24
Rated output (Pn)	kW	19
Seasonal energy efficiency of ambient heating (η_s)	%	92
Water heating energy efficiency (η_{wh})	%	84
Nominal heat input (Qn)	kW	20,0
Nominal heat output (80-60°C) (Pn)	kW	19,4
Heat output (50-30°C)	kW	21,2
Reduced heat input (Qr)	kW	5,0
Useful efficiency at nominal input (80-60°C)	%	97,1
Useful efficiency at nominal input (50-30°C)	%	106,1
Useful efficiency at 30% (30°C return)	%	108,1
Heating expansion vessel capacity	l	9
DHW nominal heat input	kW	24,0
Specific DHW flow $\Delta T=30K$	l/min	12,0
NOx emission class	-	6
Electric protection rating	IP	IPX4D

For other technical specifications, see from page 77 - Maximum length of flue gas venting, see page 90

Item	Description	Code	Item	Description	Code
	Coaxial kit \varnothing 60/100 length 75cm	0CONDASP00		Splitter kit \varnothing 80+80	0KITSDOP08
	Remote control, ErP V class (118x85x32 mm)	0CREMOTO04		External probe (60x45x31 mm)	0SONDAES01
	Thermostat starter kit + Spot gateway	0SPOTAPP01		Magnetic dirt separator filter	0AFILDEF00
	Zone expansion for Spot thermostat	0EXPSPOT01		Compact wall pipe cover - Height 110 mm - Width 400 mm - Depth (upper part) 194 mm - Depth (lower part) 165 mm	0COPETUB00
	Ambient temperature probe	0KITSAMB00		Tap kit with filter KC-KRB-CT-RBT	0KITRUBI05
	Coaxial fitting kit \varnothing 60/100	0KITATCO00		Coax. adapter kit D.60/100 to D.80/125	0KITADCO00

For other accessories, see from page 89



How to increase energy efficiency?

Discover the most suitable solution

Seasonal energy efficiency of ambient heating (η_s)			
Regulation device		Code	KC 24
Option 1	Boiler + external probe	0SONDAES01	94%
Option 2	Boiler + room temperature probe	0KITSAMB00	94%
Option 3	Boiler + remote control	0CREMOTO04	95%
Option 4	Boiler+ remote control + external probe	0CREMOTO04	96%
		0SONDAES01	

ITACA CH KR

WALL-HUNG CONDENSING BOILER CH ONLY
CASCADE INSTALLATION UP TO 900 KW



- ▶ **High modulation ratios, up to 1:10**
- ▶ **Integrated flue gas check valve**
- ▶ **Multilingual user's interface**
- ▶ **Possibility to connect up to 6 boilers in a cascade-type connection with Master-Slave logic**
 -) High-efficiency stainless steel heat exchanger
 -) Variable speed combustion fan
 -) Alarm output or LPG valve control, input for external probe, ambient thermostat, hot water storage tank probe, connection for solar pump, plant pump
 -) 0-10 V control on temperature or power
 -) Supplied as standard: split air/flue gas kit, paper template, wall installation kit, condensation drain trap, intake closing plugs

Available in the following models:



It is possible to connect up to 6 boilers in a cascade-type connection.

The cascade installation has to be composed by boilers of the same or very next size in the power range (for instance 45 – 60 kW, 60 – 85 kW, 85 – 120 kW, 120 – 150 kW)

We recommend to install cascade boilers of equal power

Model	Gas type	Code	Heat input	Energy efficiency class	W x H x D	Gross weight
			Nominal (Qn) kW	Room heating	mm	kg
CH KR 45	NATURAL GAS	KITXX2KR45	40,0	A	500x834x510	71,0
	PROPANE	KITXX6KR45				
CH KR 60	NATURAL GAS	KITXX2KR60	60,0	A	500x834x510	75,5
	PROPANE	KITXX6KR60				
CH KR 85	NATURAL GAS	KITXX2KR85	81,0	-	500x834x510	100,0
	PROPANE	KITXX6KR85				
CH KR 120	NATURAL GAS	KITXX2KR1C	115,0	-	500x883x689	112,0
	PROPANE	KITXX6KR1C				
CH KR 150	NATURAL GAS	KITXX2KR1F	140,0	-	500x883x689	133,5
	PROPANE	KITXX6KR1F				

Packages ITACA CH KR					
Model	CH KR 45	CH KR 60	CH KR 85	CH KR 120	CH KR 150
Gas type	NATURAL GAS	NATURAL GAS	NATURAL GAS	NATURAL GAS	NATURAL GAS
Package Code	KIPXX2KR45	KIPXX2KR60	KIPXX2RR85	KIPXX2RR1C	KIPXX2RR1F
Boiler	KITXX2KR45	KITXX2KR60	KITXX2KR85	KITXX2KR1C	KITXX2KR1F
Pump	OKCIRC0L00	OKCIRC0L00	OKCIRC0L05	OKCIRC0L07	OKCIRC0L07



mod. CH KR 45



mod. CH KR 60



mod. CH KR 85



mod. CH KR 120



mod. CH KR 150

DIMENSIONS AND CONNECTION CENTRE DISTANCES

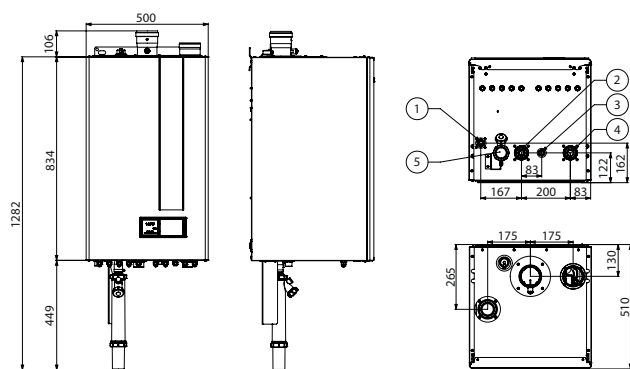

mod. CH KR 45 - 60 - 85

Those boilers must be installed with condensing flue gases ducts. The standard starting kit configuration is splitted 80 + 80. Flue gases coaxial 125/80 parts are available

- 1 Gas inlet (3/4")
- 2 Flow (1 1/4")
- 3 Safety relief valve drain (1/2")
- 4 Return (1 1/4")
- 5 Drain pipe

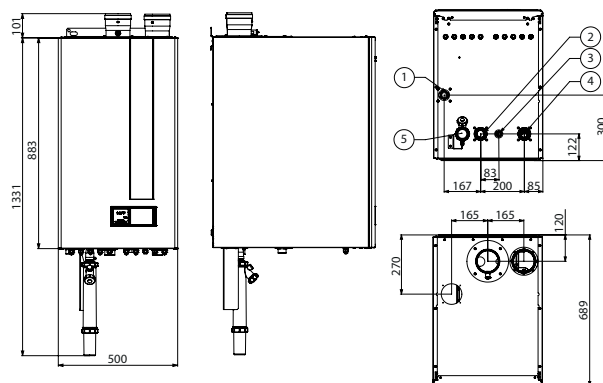

mod. CH KR 120 - 150

Those boilers must be installed with condensing flue gases ducts. The standard starting kit configuration is splitted 100 + 100. Flue gases coaxial 150/100 parts are available

- 1 Gas inlet (1")
- 2 Flow (1 1/4")
- 3 Safety relief valve drain (1/2")
- 4 Return (1 1/4")
- 5 Drain pipe

Technical data	um	CH KR 45	CH KR 60	CH KR 85	CH KR 120	CH KR 150
Rated output (Pn)	kW	39	58	79	112	136
Seasonal energy efficiency of ambient heating (η_s)	%	92	93	93	93	93
Nominal heat input (Qn)	kW	40,0	60,0	81,0	115,0	140,0
Nominal heat output (80-60°C) (Pn)	kW	38,5	58,3	78,5	112,0	136,3
Heat output (50-30°C)	kW	41,5	62,8	84,8	122,0	148,7
Reduced heat output (50-30°C)	kW	4,3	6,5	9,7	12,4	23,9
Useful efficiency at nominal input (80-60°C)	%	97,1	97,1	96,9	97,4	97,3
Useful efficiency at 30% (30°C return)	%	108,2	108,4	108,3	108,6	108,4
Safety valve calibration pressure	bar	3	3,5	5	5	5
CH temperature setting range	°C	20-80	20-80	20-80	20-80	20-80
NOx emission class	-	6	6	6	6	6
Power supply voltage/frequency	V/Hz	230/50	230/50	230/50	230/50	230/50
Maximum power consumption	W	94	119	156	251	310
Electric protection rating	IP	IPX4D	IPX4D	IPX4D	IPX4D	IPX4D
Maximum CH system pressure (PMS)	bar	3,6	4,2	6	6	6
Water content	l	2,2	3,3	4,3	6,7	9,2

For other technical specifications, see from page 78 - Maximum length of flue gas venting, see page 90



How to increase energy efficiency?

Discover the most suitable solution

Seasonal energy efficiency of ambient heating (η_s)				
Regulation device		Code	CH KR 45	CH KR 60
Option 1	Boiler + external probe	OKSONEST01	94%	95%
Option 2	Boiler + remote control	OCREMOTO04	95%	96%
Option 3	Boiler+ remote control + external probe	OKSONEST01	96%	97%
		OCREMOTO04		

INSTALLING DIMENSIONS

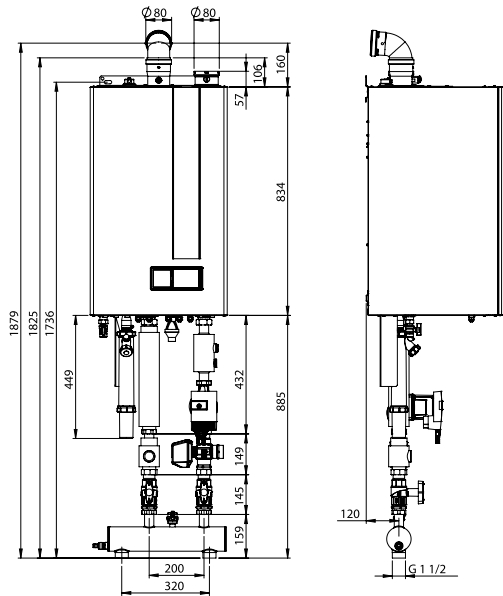

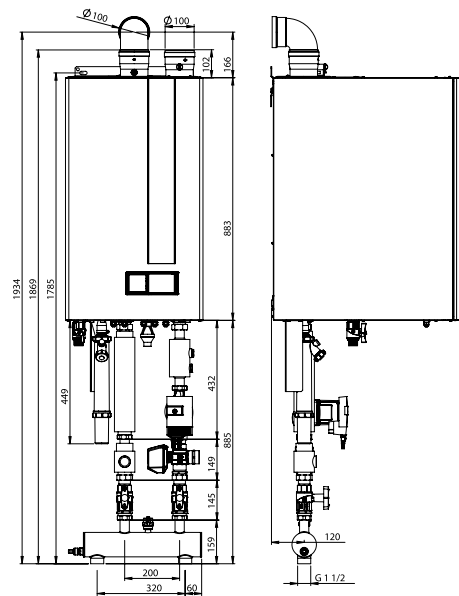

mod. CH KR 45 - 60 - 85





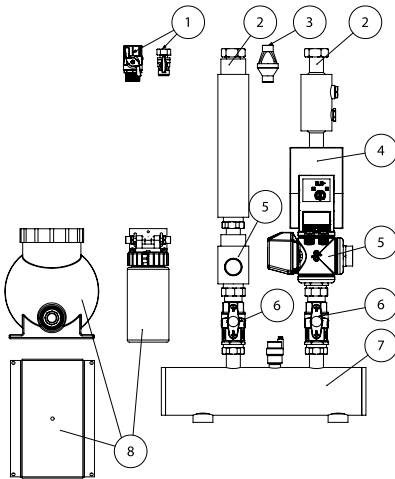

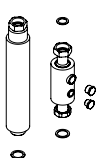





mod. CH KR 120 - 150

REF. HYDRAULIC KITS (OPTIONAL)

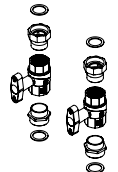
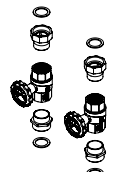
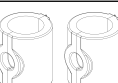
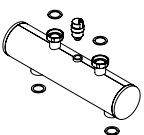



Ref.	Item	Description	Code	CH KR 45	CH KR 60	CH KR 85	CH KR 120	CH KR 150
1		Gas cock G ¾ kit	OKRUBGAS00	●	●	●		
		Gas cock G 1 kit	OKRUBGAS01				●	●
2		Hidraulic connection kit G 1 ¼ - G1 ½ the return flow connection is provided with connection for expansion vessel and for drain cock	OKCONIDR00	●	●	●	●	●
3		Drain funnel kit for G ½ F fitting safety valve (no INAIL)	OKIMBSCA00	●	●	●	●	●
4		Wilo PWM pump - 7.5 m centre distance 180 mm connections G 1 ½ M	OKCIRC0L00	●	●			

Ref.	Item	Description	Code	CH KR 45	CH KR 60	CH KR 85	CH KR 120	CH KR 150
4		Insulation casing for 0KCIRC000 provided with velcro fastening	0KISOCIR00	●	●			
		Grundfos UPML PWM pump - 10.5 m - centre distance 180 mm connections G 1 1/2 M	0KCIRC005			●		
		Grundfos UPMXL self-adjusting pump - 12 m - centre distance 180 mm connections G 1 1/2 M	0KCIRC006	●	●	●		
		Grundfos UPMXL PWM pump - 12 m - centre distance 180 mm connections G 1 1/2 M	0KCIRC007				●	●
		Grundfos Pump UPMXXL PWM - 12 m - centre distance 180 mm G 1 1/2 M connections	0KCIRC008				●	●
5		3 way valve kit for dhw tank	0KTREVB00	●	●	●	●	●
6		Hydraulic taps provided with fittings G 1 1/2 and gaskets	0KRUBMAN00	●	●	●	●	●
		Hydraulic taps with thermometer provided with fittings G 1 1/2 and gaskets	0KRUBMAN01	●	●	●	●	●
		Insulation for main / return flow tap - shell equipped with Velcro	0KISORUB00	●	●	●	●	●
7		Hydraulic separator 3", relief valve (1/2") and cap included Pump - hydraulic separator recommended coupling (see 0KCIRC005) PWM pump - 8 m Insulation included	0KSEPIDR00	●	●	●	●	●
8		Condensate neutralizer kit (Pmax 85 kw)	0FILNECO03	●	●	●		
		Condensate neutralizer kit (Pmax 350 kw)	0FILNECO01				●	●
		Support for neutralizer	0KBASFIL00				●	●



Ref.	Item	Description	Code	CH KR 45	CH KR 60	CH KR 85	CH KR 120	CH KR 150
	 x5	PG9 cable gland (x5)	0KPRESPG00	●	●	●	●	●
		Paper Installation template	0DIMACAR29	●	●	●	●	●
		Remote control, ErP V class (118x85x32 mm)	0CREMOTO04	●	●	●	●	●
		hot water storage tank temperature probe 3m	0KITSOND00	●	●	●	●	●
		External probe	0KSONEST01	●	●	●	●	●
		Cascade controlling probe	0KSONDCO00	●	●	●	●	●
		Heating zones management kit, 2 low-temperature zones and 1 high-temperature zone, with two probes included	0KGESTZO00	●	●	●	●	●
		Master slave connection kit 45-150 kW	0KITCASC00	●	●	●	●	●
		Master slave connection kit 45-150kw (back)	0KITCASC01	●	●	●	●	●
		Kit Modbus Itaca CH	0KMODBUS00	●	●	●	●	●
		Antifreeze kit for Itaca CH KR siphon (including insulation panels to be applied around the siphon)	0KANTIGE03	●	●	●	●	●
		Coaxial kit 80/125 for 45-60-85 kW (items normally not available in stock, minimum availability time 8 weeks)	0KITASCA02	●	●	●		

Item	Description	Code	CH KR 45	CH KR 60	CH KR 85	CH KR 120	CH KR 150
	Coaxial flue gases starting kit 125/80	0ATTCOFL01	●	●	●		
	Coaxial flue gases starting kit 150/100	0ATTCOFL00				●	●



ITACA CH KR MODULE FOR INDOOR INSTALLATION

MODULAR CONDENSING HEAT GENERATOR FOR COMMERCIAL HEATING



- ▶ **Multilingual user's interface**
- ▶ **High-efficiency stainless steel heat exchanger**
- ▶ **CH water flow rate double electronic control**
- ▶ **High modulation ratios: for single module up to 1:10; for modular generator up to 1:70**
- ▶ **Integrated cascade management system**
- ▶ **Possibility to connect up to 6 boilers in a cascade-type connection**
- ▶ **Integrated flue gas check valve**
-) Indoor installations on supporting structure
-) Under-boiler hydraulic unit to be installed with water (insulated) and gas collectors, high-efficiency circulation pump, water and gas connecting ramps
-) Two-way shut-off taps on flow and return
-) Alarm output or LPG valve control, input for external probe, ambient thermostat, hot water storage tank probe, connection for solar pump, plant pump
-) 0-10 V control on temperature or power
-) Cascade management with Master Slave system from boiler control panel
-) Available in the following versions: with direct collectors; with hydraulic separator; with plate exchanger
-) Class 6 of NOx emissions

Available in the following models:

from **45** to **900**

The declared efficiency class is not requested for output models above 70 kW.



WARNING

The modular heat generators on supporting frame described in this section of the catalogue must be exclusively installed indoors. The outdoor installation is not included

The modular generator is offered in the following configurations

Configuration with modular generator	
Direct collectors	Modular generator connected to the primary circuit without separating device in the hydraulic circuit (*)
With hydraulic separator	Modular generator with connection to the primary circuit, provided with hydraulic separator for the separation of the primary and secondary circuit
With plate exchanger	Modular generator with connection to the primary circuit, provided with plate exchanger for the separation of the primary and secondary circuit

(*) It is mandatory to combine a hydraulic separator or a plate exchanger to separate the primary circuit (cascade side) from the secondary circuit (plant side)

For more information visit our website www.fondital.com and download the Catalogue "Itaca CH KR Modules".

Direct collector configuration (*)

Model	Gas type	Code	Nominal heat input (Qn)	Heat output (50-30°C)	Modules
			kW	kW	Nr (nr x [model])
WALL MODULE 45	NATURAL GAS	KIQXX2SD45	40,0	41,5	1 (1 x 45)
WALL MODULE 60	NATURAL GAS	KIQXX2SD60	60,0	62,8	1 (1 x 60)
WALL MODULE 85	NATURAL GAS	KIQXX2SD85	81,0	84,8	1 (1 x 85)
WALL MODULE 90 (**)	NATURAL GAS	KIQXX2SD90	80,0	83,0	2 (2 x 45)
WALL MODULE 105 (**)	NATURAL GAS	KIQXX2SDA1	100,0	104,3	2 (1 x 60 + 1 x 45)
WALL MODULE 120	NATURAL GAS	KIQXX2SD1C	115,0	122,0	1 (1 x 120)
WALL MODULE 150	NATURAL GAS	KIQXX2SD1F	140,0	148,7	1 (1 x 150)
WALL MODULE 170	NATURAL GAS	KIQXX2SD1H	162,0	169,6	2 (2 x 85)
WALL MODULE 205	NATURAL GAS	KIQXX2SDA2	196,0	206,8	2 (1 x 85 + 1 x 120)
WALL MODULE 240	NATURAL GAS	KIQXX2SD2E	230,0	244,0	2 (2 x 120)
WALL MODULE 270	NATURAL GAS	KIQXX2SD2H	255,0	270,7	2 (1 x 120 + 1 x 150)
WALL MODULE 300	NATURAL GAS	KIQXX2SD3A	280,0	297,4	2 (2 x 150)
WALL MODULE 325	NATURAL GAS	KIQXX2SDC3	311,0	328,8	3 (1 x 85 + 2 x 120)
WALL MODULE 360	NATURAL GAS	KIQXX2SD3G	345,0	366,0	3 (3 x 120)
WALL MODULE 390	NATURAL GAS	KIQXX2SD3J	370,0	392,7	3 (2 x 120 + 1 x 150)
WALL MODULE 420	NATURAL GAS	KIQXX2SD4C	395,0	419,4	3 (1 x 120 + 2 x 150)
WALL MODULE 450	NATURAL GAS	KIQXX2SD4F	420,0	446,1	3 (3 x 150)
WALL MODULE 480	NATURAL GAS	KIQXX2SD4I	460,0	488,0	4 (4 x 120)
WALL MODULE 510	NATURAL GAS	KIQXX2SD5B	485,0	514,7	4 (3 x 120 + 1 x 150)
WALL MODULE 540	NATURAL GAS	KIQXX2SD5E	510,0	541,4	4 (2 x 120 + 2 x 150)
WALL MODULE 570	NATURAL GAS	KIQXX2SD5H	535,0	568,1	4 (1 x 120 + 3 x 150)
WALL MODULE 600	NATURAL GAS	KIQXX2SD6A	560,0	594,8	4 (4 x 150)
WALL MODULE 630	NATURAL GAS	KIQXX2SD6D	600,0	636,7	5 (4 x 120 + 1 x 150)
WALL MODULE 660	NATURAL GAS	KIQXX2SD6G	625,0	663,4	5 (3 x 120 + 2 x 150)
WALL MODULE 690	NATURAL GAS	KIQXX2SD6J	650,0	690,1	5 (2 x 120 + 3 x 150)
WALL MODULE 720	NATURAL GAS	KIQXX2SD7C	675,0	716,8	5 (1 x 120 + 4 x 150)
WALL MODULE 750	NATURAL GAS	KIQXX2SD7F	700,0	743,5	5 (5 x 150)
WALL MODULE 780	NATURAL GAS	KIQXX2SD7I	740,0	785,4	6 (4 x 120 + 2 x 150)
WALL MODULE 810	NATURAL GAS	KIQXX2SD8B	765,0	812,1	6 (3x120 + 3 x 150)
WALL MODULE 870	NATURAL GAS	KIQXX2SD8H	815,0	865,5	6 (1 x 120 + 5 x 150)
WALL MODULE 900	NATURAL GAS	KIQXX2SD9A	840,0	892,2	6 (6 x 150)

(*) It is mandatory to combine a hydraulic separator or a plate exchanger to separate the primary circuit (cascade side) from the secondary circuit (plant side)

(**) Versions of modular generators offered to create a low power heating system, spread on 2 heat generators instead of 1

Configuration with hydraulic separator

Model	Gas type	Code	Nominal heat input (Qn)	Heat output (50-30°C)	Modules
			kW	kW	Nr (nr x [model])
WALL MODULE 45	NATURAL GAS	KIQXX2SA45	40,0	41,5	1 (1 x 45)
WALL MODULE 60	NATURAL GAS	KIQXX2SA60	60,0	62,8	1 (1 x 60)
WALL MODULE 85	NATURAL GAS	KIQXX2SA85	81,0	84,8	1 (1 x 85)
WALL MODULE 90 (**)	NATURAL GAS	KIQXX2SA90	80,0	83,0	2 (2 x 45)
WALL MODULE 105 (**)	NATURAL GAS	KIQXX2SAA1	100,0	104,3	2 (1 x 60 + 1 x 45)
WALL MODULE 120	NATURAL GAS	KIQXX2SA1C	115,0	122,0	1 (1 x 120)
WALL MODULE 150	NATURAL GAS	KIQXX2SA1F	140,0	148,7	1 (1 x 150)
WALL MODULE 170	NATURAL GAS	KIQXX2SA1H	162,0	169,6	2 (2 x 85)
WALL MODULE 205	NATURAL GAS	KIQXX2SAA2	196,0	206,8	2 (1 x 85 + 1 x 120)
WALL MODULE 240	NATURAL GAS	KIQXX2SA2E	230,0	244,0	2 (2 x 120)
WALL MODULE 270	NATURAL GAS	KIQXX2SA2H	255,0	270,7	2 (1 x 120 + 1 x 150)
WALL MODULE 300	NATURAL GAS	KIQXX2SA3A	280,0	297,4	2 (2 x 150)
WALL MODULE 325	NATURAL GAS	KIQXX2SAC3	311,0	328,8	3 (1 x 85 + 2 x 120)
WALL MODULE 360	NATURAL GAS	KIQXX2SA3G	345,0	366,0	3 (3 x 120)
WALL MODULE 390	NATURAL GAS	KIQXX2SA3J	370,0	392,7	3 (2 x 120 + 1 x 150)
WALL MODULE 420	NATURAL GAS	KIQXX2SA4C	395,0	419,4	3 (1 x 120 + 2 x 150)
WALL MODULE 450	NATURAL GAS	KIQXX2SA4F	420,0	446,1	3 (3 x 150)
WALL MODULE 480	NATURAL GAS	KIQXX2SA4I	460,0	488,0	4 (4 x 120)
WALL MODULE 510	NATURAL GAS	KIQXX2SA5B	485,0	514,7	4 (3 x 120 + 1 x 150)
WALL MODULE 540	NATURAL GAS	KIQXX2SA5E	510,0	541,4	4 (2 x 120 + 2 x 150)
WALL MODULE 570	NATURAL GAS	KIQXX2SA5H	535,0	568,1	4 (1 x 120 + 3 x 150)
WALL MODULE 600	NATURAL GAS	KIQXX2SA6A	560,0	594,8	4 (4 x 150)
WALL MODULE 630	NATURAL GAS	KIQXX2SA6D	600,0	636,7	5 (4 x 120 + 1 x 150)
WALL MODULE 660	NATURAL GAS	KIQXX2SA6G	625,0	663,4	5 (3 x 120 + 2 x 150)
WALL MODULE 690	NATURAL GAS	KIQXX2SA6J	650,0	690,1	5 (2 x 120 + 3 x 150)
WALL MODULE 720	NATURAL GAS	KIQXX2SA7C	675,0	716,8	5 (1 x 120 + 4 x 150)
WALL MODULE 750	NATURAL GAS	KIQXX2SA7F	700,0	743,5	5 (5 x 150)
WALL MODULE 780	NATURAL GAS	KIQXX2SA7I	740,0	785,4	6 (4 x 120 + 2 x 150)
WALL MODULE 810	NATURAL GAS	KIQXX2SA8B	765,0	812,1	6 (3x120 + 3 x 150)
WALL MODULE 870	NATURAL GAS	KIQXX2SA8H	815,0	865,5	6 (1 x 120 + 5 x 150)
WALL MODULE 900	NATURAL GAS	KIQXX2SA9A	840,0	892,2	6 (6 x 150)

(**) Versions of modular generators offered to create a low power heating system, spread on 2 heat generators instead of 1

Configuration with plate exchanger (*)					
Model	Gas type	Code	Nominal heat input (Qn)	Heat output (50-30°C)	Modules
			kW	kW	Nr (nr x [model])
WALL MODULE 45	NATURAL GAS	KIQXX2SB45	40,0	41,5	1 (1 x 45)
WALL MODULE 60	NATURAL GAS	KIQXX2SB60	60,0	62,8	1 (1 x 60)
WALL MODULE 85	NATURAL GAS	KIQXX2SB85	81,0	84,8	1 (1 x 85)
WALL MODULE 90 (**)	NATURAL GAS	KIQXX2SB90	80,0	83,0	2 (2 x 45)
WALL MODULE 105 (**)	NATURAL GAS	KIQXX2SBA1	100,0	104,3	2 (1 x 60 + 1 x 45)
WALL MODULE 120	NATURAL GAS	KIQXX2SB1C	115,0	122,0	1 (1 x 120)
WALL MODULE 150	NATURAL GAS	KIQXX2SB1F	140,0	148,7	1 (1 x 150)
WALL MODULE 170	NATURAL GAS	KIQXX2SB1H	162,0	169,6	2 (2 x 85)
WALL MODULE 205	NATURAL GAS	KIQXX2SBA2	196,0	206,8	2 (1 x 85 + 1 x 120)
WALL MODULE 240	NATURAL GAS	KIQXX2SB2E	230,0	244,0	2 (2 x 120)
WALL MODULE 270	NATURAL GAS	KIQXX2SB2H	255,0	270,7	2 (1 x 120 + 1 x 150)
WALL MODULE 300	NATURAL GAS	KIQXX2SB3A	280,0	297,4	2 (2 x 150)
WALL MODULE 325	NATURAL GAS	KIQXX2SBC3	311,0	328,8	3 (1 x 85 + 2 x 120)
WALL MODULE 360	NATURAL GAS	KIQXX2SB3G	345,0	366,0	3 (3 x 120)
WALL MODULE 390	NATURAL GAS	KIQXX2SB3J	370,0	392,7	3 (2 x 120 + 1 x 150)
WALL MODULE 420	NATURAL GAS	KIQXX2SB4C	395,0	419,4	3 (1 x 120 + 2 x 150)
WALL MODULE 450	NATURAL GAS	KIQXX2SB4F	420,0	446,1	3 (3 x 150)
WALL MODULE 480	NATURAL GAS	KIQXX2SB4I	460,0	488,0	4 (4 x 120)
WALL MODULE 510	NATURAL GAS	KIQXX2SB5B	485,0	514,7	4 (3 x 120 + 1 x 150)
WALL MODULE 540	NATURAL GAS	KIQXX2SB5E	510,0	541,4	4 (2 x 120 + 2 x 150)
WALL MODULE 570	NATURAL GAS	KIQXX2SB5H	535,0	568,1	4 (1 x 120 + 3 x 150)
WALL MODULE 600	NATURAL GAS	KIQXX2SB6A	560,0	594,8	4 (4 x 150)
WALL MODULE 630	NATURAL GAS	KIQXX2SB6D	600,0	636,7	5 (4 x 120 + 1 x 150)
WALL MODULE 660	NATURAL GAS	KIQXX2SB6G	625,0	663,4	5 (3 x 120 + 2 x 150)
WALL MODULE 690	NATURAL GAS	KIQXX2SB6J	650,0	690,1	5 (2 x 120 + 3 x 150)
WALL MODULE 720	NATURAL GAS	KIQXX2SB7C	675,0	716,8	5 (1 x 120 + 4 x 150)
WALL MODULE 750	NATURAL GAS	KIQXX2SB7F	700,0	743,5	5 (5 x 150)
WALL MODULE 780	NATURAL GAS	KIQXX2SB7I	740,0	785,4	6 (4 x 120 + 2 x 150)
WALL MODULE 810	NATURAL GAS	KIQXX2SB8B	765,0	812,1	6 (3x120 + 3 x 150)
WALL MODULE 870	NATURAL GAS	KIQXX2SB8H	815,0	865,5	6 (1 x 120 + 5 x 150)
WALL MODULE 900	NATURAL GAS	KIQXX2SB9A	840,0	892,2	6 (6 x 150)

(*) the collectors to connect the secondary circuit of the plate exchanger to the system downstream the cascade are excluded from the article code

(**) Versions of modular generators offered to create a low power heating system, spread on 2 heat generators instead of 1

ITACA CH KR MODULE BACK ON BACK



MODULAR CONDENSING HEAT GENERATOR FOR COMMERCIAL HEATING



- ▶ **Multilingual user's interface**
- ▶ **High-efficiency stainless steel heat exchanger**
- ▶ **CH water flow rate double electronic control**
- ▶ **High modulation ratios: for single module up to 1:10; for modular generator up to 1:70**
- ▶ **Integrated cascade management system**
- ▶ **Possibility to combine up to 6 modules (3 in line at the front + 3 in line at the back)**
- ▶ **Integrated flue gas check valve**
-) Indoor installations on supporting structure
-) Under-boiler hydraulic unit to be installed with water (insulated) and gas collectors, high-efficiency circulation pump, water and gas connecting ramps
-) Under-boiler hydraulic unit on back side complete with water (with insulation) and gas connection ramps, 2-way flow and return taps, non-return valve, high-efficiency circulation pump
-) Two-way shut-off taps on flow and return
-) Alarm output or LPG valve control, input for external probe, ambient thermostat, hot water storage tank probe, connection for solar pump, plant pump
-) 0-10 V control on temperature or power
-) Available in the following versions: with direct collectors; with hydraulic separator; with plate exchanger
-) Class 6 of NOx emissions

Available in the following models:

from **90** to **900**



WARNING

The modular heat generators on supporting frame described in this section of the catalogue must be exclusively installed indoors. The outdoor installation is not included

The modular generator is offered in the following configurations

Configuration with modular generator	
Direct collectors	Modular generator connected to the primary circuit without separating device in the hydraulic circuit (*)
With hydraulic separator	Modular generator with connection to the primary circuit, provided with hydraulic separator for the separation of the primary and secondary circuit
With plate exchanger	Modular generator with connection to the primary circuit, provided with plate exchanger for the separation of the primary and secondary circuit

(*) It is mandatory to combine a hydraulic separator or a plate exchanger to separate the primary circuit (cascade side) from the secondary circuit (plant side)

For more information visit our website www.fondital.com and download the Catalogue "Itaca CH KR Modules".



Direct collector configuration (*)					
Model	Gas type	Code	Nominal heat input (Q _n)	Heat output (50-30°C)	Modules
			kW	kW	Nr (nr x [model])
WALL MODULE 90	NATURAL GAS	KIRXX2SD90	80	83	2 (2 x 45)
WALL MODULE 120	NATURAL GAS	KIRXX2SD1C	120	125,6	2 (2 x 60)
WALL MODULE 145	NATURAL GAS	KIRXX2SDE1	141	147,6	2 (1 x 60 + 1 x 85)
WALL MODULE 170	NATURAL GAS	KIRXX2SD1H	162	169,6	2 (2 x 85)
WALL MODULE 180	NATURAL GAS	KIRXX2SD1I	180	188,4	3 (3 x 60)
WALL MODULE 205	NATURAL GAS	KIRXX2SDA2	201	210,4	3 (2 x 60 + 1 x 85)
WALL MODULE 240	NATURAL GAS	KIRXX2SD2E	230	244	2 (2 x 120)
WALL MODULE 255	NATURAL GAS	KIRXX2SDF2	243	254,4	3 (3 x 85)
WALL MODULE 270	NATURAL GAS	KIRXX2SD2H	255	270,7	2 (1 x 120 + 1 x 150)
WALL MODULE 300	NATURAL GAS	KIRXX2SD3A	280	297,4	2 (2 x 150)
WALL MODULE 360	NATURAL GAS	KIRXX2SD3G	345	366	3 (3 x 120)
WALL MODULE 390	NATURAL GAS	KIRXX2SD3J	370	392,7	3 (2 x 120 + 1 x 150)
WALL MODULE 450	NATURAL GAS	KIRXX2SD4F	420	446,1	3 (3 x 150)
WALL MODULE 480	NATURAL GAS	KIRXX2SD4I	460	488	4 (4 x 120)
WALL MODULE 540	NATURAL GAS	KIRXX2SD5E	510	541,4	4 (2 x 120 + 2 x 150)
WALL MODULE 600	NATURAL GAS	KIRXX2SD6A	560	594,8	4 (4 x 150)
WALL MODULE 660	NATURAL GAS	KIRXX2SD6G	625	663,4	5 (3 x 120 + 2 x 150)
WALL MODULE 750	NATURAL GAS	KIRXX2SD7F	700	743,5	5 (5 x 150)
WALL MODULE 810	NATURAL GAS	KIRXX2SD8B	765	812,1	6 (3 x 120 + 3 x 150)
WALL MODULE 900	NATURAL GAS	KIRXX2SD9A	840	892,2	6 (6 x 150)

(*) It is mandatory to combine a hydraulic separator or a plate exchanger to separate the primary circuit (cascade side) from the secondary circuit (plant side)

Configuration with hydraulic separator

Model	Gas type	Code	Nominal heat input (Qn)	Heat output (50-30°C)	Modules
			kW	kW	Nr (nr x [model])
WALL MODULE 90	NATURAL GAS	KIRXX2SA90	80	83	2 (2 x 45)
WALL MODULE 120	NATURAL GAS	KIRXX2SA1C	120	125,6	2 (2 x 60)
WALL MODULE 145	NATURAL GAS	KIRXX2SAE1	141	147,6	2 (1 x 60 + 1 x 85)
WALL MODULE 170	NATURAL GAS	KIRXX2SA1H	162	169,6	2 (2 x 85)
WALL MODULE 180	NATURAL GAS	KIRXX2SA11	180	188,4	3 (3 x 60)
WALL MODULE 205	NATURAL GAS	KIRXX2SAA2	201	210,4	3 (2 x 60 + 1 x 85)
WALL MODULE 240	NATURAL GAS	KIRXX2SA2E	230	244	2 (2 x 120)
WALL MODULE 255	NATURAL GAS	KIRXX2SAF2	243	254,4	3 (3 x 85)
WALL MODULE 270	NATURAL GAS	KIRXX2SA2H	255	270,7	2 (1 x 120 + 1 x 150)
WALL MODULE 300	NATURAL GAS	KIRXX2SA3A	280	297,4	2 (2 x 150)
WALL MODULE 360	NATURAL GAS	KIRXX2SA3G	345	366	3 (3 x 120)
WALL MODULE 390	NATURAL GAS	KIRXX2SA3J	370	392,7	3 (2 x 120 + 1 x 150)
WALL MODULE 450	NATURAL GAS	KIRXX2SA4F	420	446,1	3 (3 x 150)
WALL MODULE 480	NATURAL GAS	KIRXX2SA4I	460	488	4 (4 x 120)
WALL MODULE 540	NATURAL GAS	KIRXX2SA5E	510	541,4	4 (2 x 120 + 2 x 150)
WALL MODULE 600	NATURAL GAS	KIRXX2SA6A	560	594,8	4 (4 x 150)
WALL MODULE 660	NATURAL GAS	KIRXX2SA6G	625	663,4	5 (3 x 120 + 2 x 150)
WALL MODULE 750	NATURAL GAS	KIRXX2SA7F	700	743,5	5 (5 x 150)
WALL MODULE 810	NATURAL GAS	KIRXX2SA8B	765	812,1	6 (3 x 120 + 3 x 150)
WALL MODULE 900	NATURAL GAS	KIRXX2SA9A	840	892,2	6 (6 x 150)

Configuration with plate exchanger (*)					
Model	Gas type	Code	Nominal heat input (Q _n)	Heat output (50-30°C)	Modules
			kW	kW	Nr (nr x [model])
WALL MODULE 90	NATURAL GAS	KIRXX2SB90	80	83	2 (2 x 45)
WALL MODULE 120	NATURAL GAS	KIRXX2SB1C	120	125,6	2 (2 x 60)
WALL MODULE 145	NATURAL GAS	KIRXX2SBE1	141	147,6	2 (1 x 60 + 1 x 85)
WALL MODULE 170	NATURAL GAS	KIRXX2SB1H	162	169,6	2 (2 x 85)
WALL MODULE 180	NATURAL GAS	KIRXX2SB1I	180	188,4	3 (3 x 60)
WALL MODULE 205	NATURAL GAS	KIRXX2SBA2	201	210,4	3 (2 x 60 + 1 x 85)
WALL MODULE 240	NATURAL GAS	KIRXX2SB2E	230	244	2 (2 x 120)
WALL MODULE 255	NATURAL GAS	KIRXX2SBF2	243	254,4	3 (3 x 85)
WALL MODULE 270	NATURAL GAS	KIRXX2SB2H	255	270,7	2 (1 x 120 + 1 x 150)
WALL MODULE 300	NATURAL GAS	KIRXX2SB3A	280	297,4	2 (2 x 150)
WALL MODULE 360	NATURAL GAS	KIRXX2SB3G	345	366	3 (3 x 120)
WALL MODULE 390	NATURAL GAS	KIRXX2SB3J	370	392,7	3 (2 x 120 + 1 x 150)
WALL MODULE 450	NATURAL GAS	KIRXX2SB4F	420	446,1	3 (3 x 150)
WALL MODULE 480	NATURAL GAS	KIRXX2SB4I	460	488	4 (4 x 120)
WALL MODULE 540	NATURAL GAS	KIRXX2SB5E	510	541,4	4 (2 x 120 + 2 x 150)
WALL MODULE 600	NATURAL GAS	KIRXX2SB6A	560	594,8	4 (4 x 150)
WALL MODULE 660	NATURAL GAS	KIRXX2SB6G	625	663,4	5 (3 x 120 + 2 x 150)
WALL MODULE 750	NATURAL GAS	KIRXX2SB7F	700	743,5	5 (5 x 150)
WALL MODULE 810	NATURAL GAS	KIRXX2SB8B	765	812,1	6 (3 x 120 + 3 x 150)
WALL MODULE 900	NATURAL GAS	KIRXX2SB9A	840	892,2	6 (6 x 150)

(*) the collectors to connect the secondary circuit of the plate exchanger to the system downstream the cascade are excluded from the article code



ITACA CH KR CABINET MODULE

MODULAR CONDENSING HEAT GENERATOR FOR COMMERCIAL HEATING



- ▶ **Polyester powder coated steel cabinet for outdoor installation**
- ▶ **Multilingual user's interface**
- ▶ **High-efficiency stainless steel heat exchanger**
- ▶ **CH water flow rate double electronic control**
- ▶ **High modulation ratios: for single module up to 1:10; for modular generator up to 1:70**
- ▶ **Integrated cascade management system**
- ▶ **Possibility to connect up to 6 boilers in a cascade-type connection**
- ▶ **Integrated flue gas check valve**
-) Under-boiler hydraulic unit to be installed with water (insulated) and gas collectors, high-efficiency circulation pump, water and gas connecting ramps, expansion vessel
-) Two-way shut-off taps on flow and return
-) Alarm output or LPG valve control, input for external probe, ambient thermostat, hot water storage tank probe, connection for solar pump, plant pump
-) 0-10 V control on temperature or power
-) Cascade management with Master Slave system from boiler control panel
-) Available in the following versions: with direct collectors; with hydraulic separator; with plate exchanger

Available in the following models:

The declared efficiency class is not requested for output models above 70 kW.

from **45** to **900**

The modular generator is offered in the following configurations

Configuration with modular generator	
Direct collectors	Modular generator connected to the primary circuit without separating device in the hydraulic circuit (*)
With hydraulic separator	Modular generator with connection to the primary circuit, provided with hydraulic separator for the separation of the primary and secondary circuit
With plate exchanger	Modular generator with connection to the primary circuit, provided with plate exchanger for the separation of the primary and secondary circuit

(*) It is mandatory to combine a hydraulic separator or a plate exchanger to separate the primary circuit (cascade side) from the secondary circuit (plant side)

For more information visit our website www.fondital.com and download the Catalogue "Itaca CH KR Modules".



Direct collector configuration (*)					
Model	Gas type	Code	Nominal heat input (Qn)	Heat output (50-30°C)	Modules
			kW	kW	Nr (nr x [model])
CABINET MODULE 45	NATURAL GAS	KIQXX2SO45	40,0	41,5	1 (1 x 45)
CABINET MODULE 60	NATURAL GAS	KIQXX2SO60	60,0	62,8	1 (1 x 60)
CABINET MODULE 85	NATURAL GAS	KIQXX2SO85	81,0	84,8	1 (1 x 85)
CABINET MODULE 90 (**)	NATURAL GAS	KIQXX2SO90	80,0	83,0	2 (2 x 45)
CABINET MODULE 105 (**)	NATURAL GAS	KIQXX2SOA1	100,0	104,3	2 (1 x 60 + 1 x 45)
CABINET MODULE 120	NATURAL GAS	KIQXX2SO1C	115,0	122,0	1 (1 x 120)
CABINET MODULE 150	NATURAL GAS	KIQXX2SO1F	140,0	148,7	1 (1 x 150)
CABINET MODULE 170	NATURAL GAS	KIQXX2SO1H	162,0	169,6	2 (2 x 85)
CABINET MODULE 205	NATURAL GAS	KIQXX2SOA2	196,0	206,8	2 (1 x 85 + 1 x 120)
CABINET MODULE 240	NATURAL GAS	KIQXX2SO2E	230,0	244,0	2 (2 x 120)
CABINET MODULE 270	NATURAL GAS	KIQXX2SO2H	255,0	270,7	2 (1 x 120 + 1 x 150)
CABINET MODULE 300	NATURAL GAS	KIQXX2SO3A	280,0	297,4	2 (2 x 150)
CABINET MODULE 325	NATURAL GAS	KIQXX2SOC3	311,0	328,8	3 (1 x 85 + 2 x 120)
CABINET MODULE 360	NATURAL GAS	KIQXX2SO3G	345,0	366,0	3 (3 x 120)
CABINET MODULE 390	NATURAL GAS	KIQXX2SO3J	370,0	392,7	3 (2 x 120 + 1 x 150)
CABINET MODULE 420	NATURAL GAS	KIQXX2SO4C	395,0	419,4	3 (1 x 120 + 2 x 150)
CABINET MODULE 450	NATURAL GAS	KIQXX2SO4F	420,0	446,1	3 (3 x 150)
CABINET MODULE 480	NATURAL GAS	KIQXX2SO4I	460,0	488,0	4 (4 x 120)
CABINET MODULE 510	NATURAL GAS	KIQXX2SO5B	485,0	514,7	4 (3 x 120 + 1 x 150)
CABINET MODULE 540	NATURAL GAS	KIQXX2SO5E	510,0	541,4	4 (2 x 120 + 2 x 150)
CABINET MODULE 570	NATURAL GAS	KIQXX2SO5H	535,0	568,1	4 (1 x 120 + 3 x 150)
CABINET MODULE 600	NATURAL GAS	KIQXX2SO6A	560,0	594,8	4 (4 x 150)
CABINET MODULE 630	NATURAL GAS	KIQXX2SO6D	600,0	636,7	5 (4 x 120 + 1 x 150)
CABINET MODULE 660	NATURAL GAS	KIQXX2SO6G	625,0	663,4	5 (3 x 120 + 2 x 150)
CABINET MODULE 690	NATURAL GAS	KIQXX2SO6J	650,0	690,1	5 (2 x 120 + 3 x 150)
CABINET MODULE 720	NATURAL GAS	KIQXX2SO7C	675,0	716,8	5 (1 x 120 + 4 x 150)
CABINET MODULE 750	NATURAL GAS	KIQXX2SO7F	700,0	743,5	5 (5 x 150)
CABINET MODULE 780	NATURAL GAS	KIQXX2SO7I	740,0	785,4	6 (4 x 120 + 2 x 150)
CABINET MODULE 810	NATURAL GAS	KIQXX2SO8B	765,0	812,1	6 (3x120 + 3 x 150)
CABINET MODULE 870	NATURAL GAS	KIQXX2SO8H	815,0	865,5	6 (1 x 120 + 5 x 150)
CABINET MODULE 900	NATURAL GAS	KIQXX2SO9A	840,0	892,2	6 (6 x 150)

(*) It is mandatory to combine a hydraulic separator or a plate exchanger to separate the primary circuit (cascade side) from the secondary circuit (plant side)

(**) Versions of modular generators offered to create a low power heating system, spread on 2 heat generators instead of 1

Configuration with hydraulic separator on the left

Model	Gas type	Code	Nominal heat input (Qn)	Heat output (50-30°C)	Modules
			kW	kW	Nr (nr x [model])
CABINET MODULE 45	NATURAL GAS	KIQXX2SK45	40,0	41,5	1 (1 x 45)
CABINET MODULE 60	NATURAL GAS	KIQXX2SK60	60,0	62,8	1 (1 x 60)
CABINET MODULE 85	NATURAL GAS	KIQXX2SK85	81,0	84,8	1 (1 x 85)
CABINET MODULE 90 (**)	NATURAL GAS	KIQXX2SK90	80,0	83,0	2 (2 x 45)
CABINET MODULE 105 (**)	NATURAL GAS	KIQXX2SKA1	100,0	104,3	2 (1 x 60 + 1 x 45)
CABINET MODULE 120	NATURAL GAS	KIQXX2SK1C	115,0	122,0	1 (1 x 120)
CABINET MODULE 150	NATURAL GAS	KIQXX2SK1F	140,0	148,7	1 (1 x 150)
CABINET MODULE 170	NATURAL GAS	KIQXX2SK1H	162,0	169,6	2 (2 x 85)
CABINET MODULE 205	NATURAL GAS	KIQXX2SKA2	196,0	206,8	2 (1 x 85 + 1 x 120)
CABINET MODULE 240	NATURAL GAS	KIQXX2SK2E	230,0	244,0	2 (2 x 120)
CABINET MODULE 270	NATURAL GAS	KIQXX2SK2H	255,0	270,7	2 (1 x 120 + 1 x 150)
CABINET MODULE 300	NATURAL GAS	KIQXX2SK3A	280,0	297,4	2 (2 x 150)
CABINET MODULE 325	NATURAL GAS	KIQXX2SKC3	311,0	328,8	3 (1 x 85 + 2 x 120)
CABINET MODULE 360	NATURAL GAS	KIQXX2SK3G	345,0	366,0	3 (3 x 120)
CABINET MODULE 390	NATURAL GAS	KIQXX2SK3J	370,0	392,7	3 (2 x 120 + 1 x 150)
CABINET MODULE 420	NATURAL GAS	KIQXX2SK4C	395,0	419,4	3 (1 x 120 + 2 x 150)
CABINET MODULE 450	NATURAL GAS	KIQXX2SK4F	420,0	446,1	3 (3 x 150)
CABINET MODULE 480	NATURAL GAS	KIQXX2SK4I	460,0	488,0	4 (4 x 120)
CABINET MODULE 510	NATURAL GAS	KIQXX2SK5B	485,0	514,7	4 (3 x 120 + 1 x 150)
CABINET MODULE 540	NATURAL GAS	KIQXX2SK5E	510,0	541,4	4 (2 x 120 + 2 x 150)
CABINET MODULE 570	NATURAL GAS	KIQXX2SK5H	535,0	568,1	4 (1 x 120 + 3 x 150)
CABINET MODULE 600	NATURAL GAS	KIQXX2SK6A	560,0	594,8	4 (4 x 150)
CABINET MODULE 630	NATURAL GAS	KIQXX2SK6D	600,0	636,7	5 (4 x 120 + 1 x 150)
CABINET MODULE 660	NATURAL GAS	KIQXX2SK6G	625,0	663,4	5 (3 x 120 + 2 x 150)
CABINET MODULE 690	NATURAL GAS	KIQXX2SK6J	650,0	690,1	5 (2 x 120 + 3 x 150)
CABINET MODULE 720	NATURAL GAS	KIQXX2SK7C	675,0	716,8	5 (1 x 120 + 4 x 150)
CABINET MODULE 750	NATURAL GAS	KIQXX2SK7F	700,0	743,5	5 (5 x 150)
CABINET MODULE 780	NATURAL GAS	KIQXX2SK7I	740,0	785,4	6 (4 x 120 + 2 x 150)
CABINET MODULE 810	NATURAL GAS	KIQXX2SK8B	765,0	812,1	6 (3x120 + 3 x 150)
CABINET MODULE 870	NATURAL GAS	KIQXX2SK8H	815,0	865,5	6 (1 x 120 + 5 x 150)
CABINET MODULE 900	NATURAL GAS	KIQXX2SK9A	840,0	892,2	6 (6 x 150)

Configuration with hydraulic separator on the right

Model	Gas type	Code	Nominal heat input (Qn)	Heat output (50-30°C)	Modules
			kW	kW	Nr (nr x [model])
CABINET MODULE 45	NATURAL GAS	KIQXX2SL45	40,0	41,5	1 (1 x 45)
CABINET MODULE 60	NATURAL GAS	KIQXX2SL60	60,0	62,8	1 (1 x 60)
CABINET MODULE 85	NATURAL GAS	KIQXX2SL85	81,0	84,8	1 (1 x 85)
CABINET MODULE 90 (**)	NATURAL GAS	KIQXX2SL90	80,0	83,0	2 (2 x 45)
CABINET MODULE 105 (**)	NATURAL GAS	KIQXX2SLA1	100,0	104,3	2 (1 x 60 + 1 x 45)
CABINET MODULE 120	NATURAL GAS	KIQXX2SL1C	115,0	122,0	1 (1 x 120)
CABINET MODULE 150	NATURAL GAS	KIQXX2SL1F	140,0	148,7	1 (1 x 150)
CABINET MODULE 170	NATURAL GAS	KIQXX2SL1H	162,0	169,6	2 (2 x 85)
CABINET MODULE 205	NATURAL GAS	KIQXX2SLA2	196,0	206,8	2 (1 x 85 + 1 x 120)
CABINET MODULE 240	NATURAL GAS	KIQXX2SL2E	230,0	244,0	2 (2 x 120)
CABINET MODULE 270	NATURAL GAS	KIQXX2SL2H	255,0	270,7	2 (1 x 120 + 1 x 150)
CABINET MODULE 300	NATURAL GAS	KIQXX2SL3A	280,0	297,4	2 (2 x 150)
CABINET MODULE 325	NATURAL GAS	KIQXX2SLC3	311,0	328,8	3 (1 x 85 + 2 x 120)
CABINET MODULE 360	NATURAL GAS	KIQXX2SL3G	345,0	366,0	3 (3 x 120)
CABINET MODULE 390	NATURAL GAS	KIQXX2SL3J	370,0	392,7	3 (2 x 120 + 1 x 150)
CABINET MODULE 420	NATURAL GAS	KIQXX2SL4C	395,0	419,4	3 (1 x 120 + 2 x 150)
CABINET MODULE 450	NATURAL GAS	KIQXX2SL4F	420,0	446,1	3 (3 x 150)
CABINET MODULE 480	NATURAL GAS	KIQXX2SL4I	460,0	488,0	4 (4 x 120)
CABINET MODULE 510	NATURAL GAS	KIQXX2SL5B	485,0	514,7	4 (3 x 120 + 1 x 150)
CABINET MODULE 540	NATURAL GAS	KIQXX2SL5E	510,0	541,4	4 (2 x 120 + 2 x 150)
CABINET MODULE 570	NATURAL GAS	KIQXX2SL5H	535,0	568,1	4 (1 x 120 + 3 x 150)
CABINET MODULE 600	NATURAL GAS	KIQXX2SL6A	560,0	594,8	4 (4 x 150)
CABINET MODULE 630	NATURAL GAS	KIQXX2SL6D	600,0	636,7	5 (4 x 120 + 1 x 150)
CABINET MODULE 660	NATURAL GAS	KIQXX2SL6G	625,0	663,4	5 (3 x 120 + 2 x 150)
CABINET MODULE 690	NATURAL GAS	KIQXX2SL6J	650,0	690,1	5 (2 x 120 + 3 x 150)
CABINET MODULE 720	NATURAL GAS	KIQXX2SL7C	675,0	716,8	5 (1 x 120 + 4 x 150)
CABINET MODULE 750	NATURAL GAS	KIQXX2SL7F	700,0	743,5	5 (5 x 150)
CABINET MODULE 780	NATURAL GAS	KIQXX2SL7I	740,0	785,4	6 (4 x 120 + 2 x 150)
CABINET MODULE 810	NATURAL GAS	KIQXX2SL8B	765,0	812,1	6 (3x120 + 3 x 150)
CABINET MODULE 870	NATURAL GAS	KIQXX2SL8H	815,0	865,5	6 (1 x 120 + 5 x 150)
CABINET MODULE 900	NATURAL GAS	KIQXX2SL9A	840,0	892,2	6 (6 x 150)

(**) Versions of modular generators offered to create a low power heating system, spread on 2 heat generators instead of 1

Configuration with plate exchanger on the left

Model	Gas type	Code	Nominal heat input (Qn)	Heat output (50-30°C)	Modules
			kW	kW	Nr (nr x [model])
CABINET MODULE 45	NATURAL GAS	KIQXX2SM45	40,0	41,5	1 (1 x 45)
CABINET MODULE 60	NATURAL GAS	KIQXX2SM60	60,0	62,8	1 (1 x 60)
CABINET MODULE 85	NATURAL GAS	KIQXX2SM85	81,0	84,8	1 (1 x 85)
CABINET MODULE 90 (**)	NATURAL GAS	KIQXX2SM90	80,0	83,0	2 (2 x 45)
CABINET MODULE 105 (**)	NATURAL GAS	KIQXX2SMA1	100,0	104,3	2 (1 x 60 + 1 x 45)
CABINET MODULE 120	NATURAL GAS	KIQXX2SM1C	115,0	122,0	1 (1 x 120)
CABINET MODULE 150	NATURAL GAS	KIQXX2SM1F	140,0	148,7	1 (1 x 150)
CABINET MODULE 170	NATURAL GAS	KIQXX2SM1H	162,0	169,6	2 (2 x 85)
CABINET MODULE 205	NATURAL GAS	KIQXX2SMA2	196,0	206,8	2 (1 x 85 + 1 x 120)
CABINET MODULE 240	NATURAL GAS	KIQXX2SM2E	230,0	244,0	2 (2 x 120)
CABINET MODULE 270	NATURAL GAS	KIQXX2SM2H	255,0	270,7	2 (1 x 120 + 1 x 150)
CABINET MODULE 300	NATURAL GAS	KIQXX2SM3A	280,0	297,4	2 (2 x 150)
CABINET MODULE 325	NATURAL GAS	KIQXX2SMC3	311,0	328,8	3 (1 x 85 + 2 x 120)
CABINET MODULE 360	NATURAL GAS	KIQXX2SM3G	345,0	366,0	3 (3 x 120)
CABINET MODULE 390	NATURAL GAS	KIQXX2SM3J	370,0	392,7	3 (2 x 120 + 1 x 150)
CABINET MODULE 420	NATURAL GAS	KIQXX2SM4C	395,0	419,4	3 (1 x 120 + 2 x 150)
CABINET MODULE 450	NATURAL GAS	KIQXX2SM4F	420,0	446,1	3 (3 x 150)
CABINET MODULE 480	NATURAL GAS	KIQXX2SM4I	460,0	488,0	4 (4 x 120)
CABINET MODULE 510	NATURAL GAS	KIQXX2SM5B	485,0	514,7	4 (3 x 120 + 1 x 150)
CABINET MODULE 540	NATURAL GAS	KIQXX2SM5E	510,0	541,4	4 (2 x 120 + 2 x 150)
CABINET MODULE 570	NATURAL GAS	KIQXX2SM5H	535,0	568,1	4 (1 x 120 + 3 x 150)
CABINET MODULE 600	NATURAL GAS	KIQXX2SM6A	560,0	594,8	4 (4 x 150)
CABINET MODULE 630	NATURAL GAS	KIQXX2SM6D	600,0	636,7	5 (4 x 120 + 1 x 150)
CABINET MODULE 660	NATURAL GAS	KIQXX2SM6G	625,0	663,4	5 (3 x 120 + 2 x 150)
CABINET MODULE 690	NATURAL GAS	KIQXX2SM6J	650,0	690,1	5 (2 x 120 + 3 x 150)
CABINET MODULE 720	NATURAL GAS	KIQXX2SM7C	675,0	716,8	5 (1 x 120 + 4 x 150)
CABINET MODULE 750	NATURAL GAS	KIQXX2SM7F	700,0	743,5	5 (5 x 150)
CABINET MODULE 780	NATURAL GAS	KIQXX2SM7I	740,0	785,4	6 (4 x 120 + 2 x 150)
CABINET MODULE 810	NATURAL GAS	KIQXX2SM8B	765,0	812,1	6 (3x120 + 3 x 150)
CABINET MODULE 870	NATURAL GAS	KIQXX2SM8H	815,0	865,5	6 (1 x 120 + 5 x 150)
CABINET MODULE 900	NATURAL GAS	KIQXX2SM9A	840,0	892,2	6 (6 x 150)

Configuration with plate exchanger on the right

Model	Gas type	Code	Nominal heat input (Qn)	Heat output (50-30°C)	Modules
			kW	kW	Nr (nr x [model])
CABINET MODULE 45	NATURAL GAS	KIQXX2SN45	40,0	41,5	1 (1 x 45)
CABINET MODULE 60	NATURAL GAS	KIQXX2SN60	60,0	62,8	1 (1 x 60)
CABINET MODULE 85	NATURAL GAS	KIQXX2SN85	81,0	84,8	1 (1 x 85)
CABINET MODULE 90 (**)	NATURAL GAS	KIQXX2SN90	80,0	83,0	2 (2 x 45)
CABINET MODULE 105 (**)	NATURAL GAS	KIQXX2SNA1	100,0	104,3	2 (1 x 60 + 1 x 45)
CABINET MODULE 120	NATURAL GAS	KIQXX2SN1C	115,0	122,0	1 (1 x 120)
CABINET MODULE 150	NATURAL GAS	KIQXX2SN1F	140,0	148,7	1 (1 x 150)
CABINET MODULE 170	NATURAL GAS	KIQXX2SN1H	162,0	169,6	2 (2 x 85)
CABINET MODULE 205	NATURAL GAS	KIQXX2SNA2	196,0	206,8	2 (1 x 85 + 1 x 120)
CABINET MODULE 240	NATURAL GAS	KIQXX2SN2E	230,0	244,0	2 (2 x 120)
CABINET MODULE 270	NATURAL GAS	KIQXX2SN2H	255,0	270,7	2 (1 x 120 + 1 x 150)
CABINET MODULE 300	NATURAL GAS	KIQXX2SN3A	280,0	297,4	2 (2 x 150)
CABINET MODULE 325	NATURAL GAS	KIQXX2SNC3	311,0	328,8	3 (1 x 85 + 2 x 120)
CABINET MODULE 360	NATURAL GAS	KIQXX2SN3G	345,0	366,0	3 (3 x 120)
CABINET MODULE 390	NATURAL GAS	KIQXX2SN3J	370,0	392,7	3 (2 x 120 + 1 x 150)
CABINET MODULE 420	NATURAL GAS	KIQXX2SN4C	395,0	419,4	3 (1 x 120 + 2 x 150)
CABINET MODULE 450	NATURAL GAS	KIQXX2SN4F	420,0	446,1	3 (3 x 150)
CABINET MODULE 480	NATURAL GAS	KIQXX2SN4I	460,0	488,0	4 (4 x 120)
CABINET MODULE 510	NATURAL GAS	KIQXX2SN5B	485,0	514,7	4 (3 x 120 + 1 x 150)
CABINET MODULE 540	NATURAL GAS	KIQXX2SN5E	510,0	541,4	4 (2 x 120 + 2 x 150)
CABINET MODULE 570	NATURAL GAS	KIQXX2SN5H	535,0	568,1	4 (1 x 120 + 3 x 150)
CABINET MODULE 600	NATURAL GAS	KIQXX2SN6A	560,0	594,8	4 (4 x 150)
CABINET MODULE 630	NATURAL GAS	KIQXX2SN6D	600,0	636,7	5 (4 x 120 + 1 x 150)
CABINET MODULE 660	NATURAL GAS	KIQXX2SN6G	625,0	663,4	5 (3 x 120 + 2 x 150)
CABINET MODULE 690	NATURAL GAS	KIQXX2SN6J	650,0	690,1	5 (2 x 120 + 3 x 150)
CABINET MODULE 720	NATURAL GAS	KIQXX2SN7C	675,0	716,8	5 (1 x 120 + 4 x 150)
CABINET MODULE 750	NATURAL GAS	KIQXX2SN7F	700,0	743,5	5 (5 x 150)
CABINET MODULE 780	NATURAL GAS	KIQXX2SN7I	740,0	785,4	6 (4 x 120 + 2 x 150)
CABINET MODULE 810	NATURAL GAS	KIQXX2SN8B	765,0	812,1	6 (3x120 + 3 x 150)
CABINET MODULE 870	NATURAL GAS	KIQXX2SN8H	815,0	865,5	6 (1 x 120 + 5 x 150)
CABINET MODULE 900	NATURAL GAS	KIQXX2SN9A	840,0	892,2	6 (6 x 150)

(**) Versions of modular generators offered to create a low power heating system, spread on 2 heat generators instead of 1

GIAVA KRB

FLOOR-STANDING CONDENSING BOILER WITH AN INTEGRATED SINGLE COIL WATER TANK FOR THE PRODUCTION OF DHW



Available in the following models:



- ▶ **130-litre water heater with single coil**
- ▶ **Available in the KRB version with one direct zone, in the KRB-V version with one direct and one mixed integrated zones, and in the KRB-Z version with one direct and two mixed integrated zones**
- ▶ **Ambient temperature probe supplied as standard**
- ▶ **Modulation ratio: 1:9**
- ▶ **Hydraulic connections on the sides**
- ▶ **Front door for immediate access to boiler**
- ▶ Thermoregulation with external probe (optional)
- ▶ Thermostating polymer-covered stainless steel heat exchanger
- ▶ 5-litre DHW expansion vessel
- ▶ Compatible with SPOT smart thermostat

Model	Gas type	Code	Heat input		Energy efficiency class		W x H x D mm	Gross weight kg
			Nominal (Qn) kW	Nominal DHW kW	Room heating	Heating DHW		
KRB 12	NATURAL GAS	KGBXX2KU12	12,0	18,0	A	A XL	600x1857x642	189,0
	PROPANE	KGBXX6KU12						
KRB 24	NATURAL GAS	KGBXX2KU24	23,7	27,3	A	A XL	600x1857x643	190,0
	PROPANE	KGBXX6KU24						
KRB 28	NATURAL GAS	KGBXX2KU28	26,4	30,4	A	A XL	600x1857x644	192,0
	PROPANE	KGBXX6KU28						
KRB 32	NATURAL GAS	KGBXX2KU32	30,4	34,5	A	A XL	600x1857x645	193,0
	PROPANE	KGBXX6KU32						
KRB V 12	NATURAL GAS	KGBXX2KV12	12,0	18,0	A	A XL	600x1857x642	201,00
	PROPANE	KGBXX6KV12						
KRB V 24	NATURAL GAS	KGBXX2KV24	23,7	27,3	A	A XL	600x1857x643	203,00
	PROPANE	KGBXX6KV24						
KRB V 28	NATURAL GAS	KGBXX2KV28	26,4	30,4	A	A XL	600x1857x644	204,00
	PROPANE	KGBXX6KV28						
KRB V 32	NATURAL GAS	KGBXX2KV32	30,4	34,5	A	A XL	600x1857x645	205,00
	PROPANE	KGBXX6KV32						
KRB Z 12	NATURAL GAS	KGBXX2KZ12	12,0	18,0	A	A XL	600x1857x642	204,00
	PROPANE	KGBXX6KZ12						
KRB Z 24	NATURAL GAS	KGBXX2KZ24	23,7	27,3	A	A XL	600x1857x643	205,00
	PROPANE	KGBXX6KZ24						
KRB Z 28	NATURAL GAS	KGBXX2KZ28	26,4	30,4	A	A XL	600x1857x644	207,00
	PROPANE	KGBXX6KZ28						
KRB Z 32	NATURAL GAS	KGBXX2KZ32	30,4	34,5	A	A XL	600x1857x645	208,00
	PROPANE	KGBXX6KZ32						



TOUCH SCREEN INTERFACE

- ▶ Modulation thermostat with ambient probe
- ▶ Day/night temperature level selection
- ▶ Weekly programming
- ▶ Timer and ambient temperature setting
- ▶ Heater DHW "comfort" function enabling

The TOUCH SCREEN interface of GIAVA KRB combined with the ambient temperature probe supplied is a class V temperature control system.



How to increase energy efficiency?

Discover the most suitable solution

Seasonal energy efficiency of ambient heating (η_s)						
Regulation device		Code	KRB 12	KRB 24	KRB 28	KRB 32
Option 1	Boiler + external probe (ambient temperature probe is not supplied)	0SONDAES01	92%	93%	93%	94%
Option 2	Boiler + external probe (ambient temperature probe is supplied)	0SONDAES01	94%	95%	95%	96%
Option 3	Boiler + remote control (ambient temperature probe is not supplied)	0CREMOTO04	93%	94%	94%	95%
Option 4	Boiler + remote control + external probe (ambient temperature probe is not supplied)	0CREMOTO04	94%	95%	95%	96%
		0SONDAES01	94%	95%	95%	96%



Technical data	um	KRB 12	KRB 24	KRB 28	KRB 32
Rated output (Pn)	kW	12	23	25	29
Seasonal energy efficiency of ambient heating (η_s)	%	90	91	91	92
Seasonal energy efficiency of ambient heating (η_s) (Boiler + ambient temperature probe)	%	93	94	94	95
Water heating energy efficiency (η_{wh})	%	83	80	82	81
Nominal heat input (Qn)	kW	12,0	23,7	26,4	30,4
Nominal heat output (80-60°C) (Pn)	kW	11,6	22,9	25,4	29,4
Heat output (50-30°C)	kW	12,6	24,9	27,9	32,3
Reduced heat input (Qr)	kW	2,0	3,0	3,3	4,2
Useful efficiency at nominal input (80-60°C)	%	97,1	96,7	96,4	96,8
Useful efficiency at nominal input (50-30°C)	%	105,1	105,1	105,5	106,2
Useful efficiency at 30% (30°C return)	%	106,0	106,5	107,0	108,3
Heating expansion vessel capacity	l	10	10	10	10
DHW nominal heat input	kW	18,0	27,3	30,4	34,5
Specific DHW flow $\Delta T=30K$	l/min	19,5	22	22,5	23,4
NOx emission class	-	6	6	6	6
Electric protection rating	IP	IPX5D	IPX5D	IPX5D	IPX5D

For other technical specifications, see from page 79 - Maximum length of flue gas venting, see page 90

Item	Description	Code	Item	Description	Code				
	Coaxial kit \varnothing 60/100 length 75cm	0CONDASP00		Electrical kit for zone management with external probe	0KITZONE05				
	Remote control, ErP V class (118x85x32 mm)	0CREMOTO04		Giava recirculation optional kit	0KRICIRC00				
	Thermostat starter kit + Spot gateway	0SPOTAPP01	For other accessories, see from page 89						
	Zone expansion for Spot thermostat	0EXSPOT01	Accessories supplied as standard <table border="1"> <thead> <tr> <th>Item</th> <th>Description</th> </tr> </thead> <tbody> <tr> <td></td> <td>Ambient temperature probe</td> </tr> </tbody> </table>			Item	Description		Ambient temperature probe
Item	Description								
	Ambient temperature probe								
	Splitter kit \varnothing 80+80	0KITSDOP08							
	External probe (60x45x31 mm)	0SONDAES01							

DIMENSIONS AND CONNECTION CENTRE DISTANCES

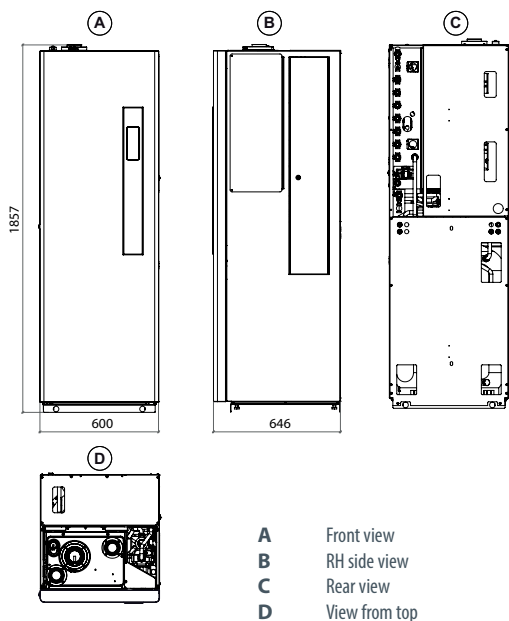

TECHNICAL SPECIFICATIONS OF CONDENSING BOILERS

Technical data	um	Itaca	Itaca	Itaca	Itaca
Model	-	KC 12	KC 24	KC 28	KC 32
Type	-	B23-B23P-B33-C13-C33-C43-C53-C63-C83-C13X-C33X-C43X-C53X-C63X-C83X-C93-C93X	B23-B23P-B33-C13-C33-C43-C53-C63-C83-C13X-C33X-C43X-C53X-C63X-C83X-C93-C93X	B23-B23P-B33-C13-C33-C43-C53-C63-C83-C13X-C33X-C43X-C53X-C63X-C83X-C93-C93X	B23-B23P-B33-C13-C33-C43-C53-C63-C83-C13X-C33X-C43X-C53X-C63X-C83X-C93-C93X
Rated output (Pn)	kW	12	23	26	29
Seasonal energy efficiency of ambient heating (η_s)	%	90	92	92	93
Seasonal energy efficiency class of ambient heating	-	A	A	A	A
Stated load profile	-	M	XL	XL	XXL
Water heating energy efficiency (η_{wh})	%	78 (**)	85 (**)	84 (**)	87 (**)
Energy efficiency class of water heating	-	A	A	A	A
Nominal heat input (Qn)	kW	12,0	23,7	26,4	30,4
Reduced heat input (Qr)	kW	2,0	3,0	3,3	4,2
Nominal heat output (80-60°C) (Pn)	kW	11,7	23,0	25,5	29,4
Reduced heat output (80-60°C) (Pr)	kW	1,8	2,6	3,0	3,9
Heat output (50-30°C)	kW	12,6	25,0	28,0	32,3
Reduced heat output (50-30°C)	kW	2,1	3,2	3,5	4,4
Useful efficiency at nominal input (80-60°C)	%	97,1	96,8	96,7	96,8
Useful efficiency at nominal input (50-30°C)	%	105,1	105,6	106,0	106,2
Useful efficiency at 30% (30°C return)	%	106,0	107,4	107,4	108,3
Heating circuit working pressure (min-max)	bar	0,5-3,0	0,5-3,0	0,5-3,0	0,5-3,0
CH temperature setting range	°C	20-78	20-78	20-78	20-78
CH maximum working temperature	°C	83	83	83	83
Heating expansion vessel capacity	l	10	10	10	10
DHW nominal heat input	kW	18,0	27,3	30,4	34,5
DHW minimum heat input	kW	2,0	3,0	3,3	4,2
DHW nominal heat output (ΔT 30°C)	kW	18,6	27,4	29,2	33,4
DHW circuit working pressure (min-max)	bar	0,5-6,0	0,5-6,0	0,5-6,0	0,5-6,0
Specific DHW flow $\Delta T=30K$	l/min	8,8	13,4	15,5	16,2
Qualification of domestic hot water	-	***	***	***	***
DHW temperature range	°C	35-57	35-57	35-57	35-57
DHW maximum working temperature	°C	62	62	62	62
NOx emission class	-	6	6	6	6
Casing heat loss with burner on at nominal heat input	%	0,40	0,44	1,04	0,87
Casing heat loss with burner off	%	0,53	0,21	0,20	0,19
Chimney heat loss with burner on at nominal heat input	%	2,50	2,72	2,26	2,33
Air-flue ΔT at nominal heat input	°C	57,9	61	60	60
Flue gas flow at nominal heat input	g/s	8,25	12,43	13,93	15,81
CO2 at nominal heat input of heating (Natural gas)	%	9	9	9	9
CO2 at nominal heat input of heating (Propane)	%	10	10	10	10
Power supply voltage/frequency	V/Hz	230/50	230/50	230/50	230/50
Maximum power consumption	W	88	97	101	106
Circulation pump power input	W	50	50	50	50
Electric protection rating	IP	IPX5D	IPX5D	IPX5D	IPX5D
Air intake/flue gas vent pipe diameter	mm	80+80 60+60 100/60 125/80	80+80 60+60 100/60 125/80	80+80 60+60 100/60 125/80	80+80 60+60 100/60 125/80

(**) with comfort function disabled.

TECHNICAL SPECIFICATIONS OF CONDENSING BOILERS

Technical data	um	Itaca	Itaca	Itaca	Itaca
Model	-	KR 12	KR 24	KR 28	KR 32
Type	-	B23-B23P-B33-C13-C33-C43-C53-C63-C83-C13X-C33X-C43X-C53X-C63X-C83X-C93-C93X	B23-B23P-B33-C13-C33-C43-C53-C63-C83-C13X-C33X-C43X-C53X-C63X-C83X-C93-C93X	B23-B23P-B33-C13-C33-C43-C53-C63-C83-C13X-C33X-C43X-C53X-C63X-C83X-C93-C93X	B23-B23P-B33-C13-C33-C43-C53-C63-C83-C13X-C33X-C43X-C53X-C63X-C83X-C93-C93X
Rated output (Pn)	kW	12	23	26	29
Seasonal energy efficiency of ambient heating (η_s)	%	90	92	92	93
Seasonal energy efficiency class of ambient heating	-	A	A	A	A
Nominal heat input (Qn)	kW	12,0	23,7	26,4	30,4
Reduced heat input (Qr)	kW	2,0	3,0	3,3	4,2
Nominal heat output (80-60°C) (Pn)	kW	11,7	23,0	25,5	29,4
Reduced heat output (80-60°C) (Pr)	kW	1,8	2,6	3,0	3,9
Heat output (50-30°C)	kW	12,6	25,0	28,0	32,3
Reduced heat output (50-30°C)	kW	2,1	3,2	3,5	4,4
Useful efficiency at nominal input (80-60°C)	%	97,1	96,8	96,7	96,8
Useful efficiency at nominal input (50-30°C)	%	105,1	105,6	106,0	106,2
Useful efficiency at 30% (30°C return)	%	106,0	107,4	107,4	108,3
Heating circuit working pressure (min-max)	bar	0,5-3,0	0,5-3,0	0,5-3,0	0,5-3,0
CH temperature setting range	°C	20-78	20-78	20-78	20-78
CH maximum working temperature	°C	83	83	83	83
Heating expansion vessel capacity	l	10	10	10	10
DHW nominal heat input	kW	18,0 (*)	27,3 (*)	30,4 (*)	34,5 (*)
DHW minimum heat input	kW	2,0 (*)	3,0 (*)	3,3 (*)	4,2 (*)
DHW temperature range	°C	35-65 (***)	35-65 (***)	35-65 (***)	35-65 (***)
DHW maximum working temperature	°C	65 (***)	65 (***)	65 (***)	65 (***)
NOx emission class	-	6	6	6	6
Casing heat loss with burner on at nominal heat input	%	0,40	0,44	1,04	0,87
Casing heat loss with burner off	%	0,53	0,21	0,20	0,19
Chimney heat loss with burner on at nominal heat input	%	2,50	2,72	2,26	2,33
Air-flue ΔT at nominal heat input	°C	57,9	61	60	60
Flue gas flow at nominal heat input	g/s	8,25	12,43	13,93	15,81
CO2 at nominal heat input of heating (Natural gas)	%	9	9	9	9
CO2 at nominal heat input of heating (Propane)	%	10	10	10	10
Power supply voltage/frequency	V/Hz	230/50	230/50	230/50	230/50
Maximum power consumption	W	88	97	101	106
Circulation pump power input	W	50	50	50	50
Electric protection rating	IP	IPX5D	IPX5D	IPX5D	IPX5D
Air intake/flue gas vent pipe diameter	mm	80+80 60+60 100/60 125/80	80+80 60+60 100/60 125/80	80+80 60+60 100/60 125/80	80+80 60+60 100/60 125/80

(*) with optional hot water storage tank.

(***) with hot water storage tank probe connected.

TECHNICAL SPECIFICATIONS OF CONDENSING BOILERS

Technical data	um	Itaca	Itaca	Itaca	Itaca
Model	-	KRB 12	KRB 24	KRB 28	KRB 32
Type	-	B23-B23P-B33-C13-C33-C43-C53-C63-C83-C13X-C33X-C43X-C53X-C63X-C83X-C93-C93X	B23-B23P-B33-C13-C33-C43-C53-C63-C83-C13X-C33X-C43X-C53X-C63X-C83X-C93-C93X	B23-B23P-B33-C13-C33-C43-C53-C63-C83-C13X-C33X-C43X-C53X-C63X-C83X-C93-C93X	B23-B23P-B33-C13-C33-C43-C53-C63-C83-C13X-C33X-C43X-C53X-C63X-C83X-C93-C93X
Rated output (Pn)	kW	12	23	26	29
Seasonal energy efficiency of ambient heating (η_s)	%	90	92	92	93
Seasonal energy efficiency class of ambient heating	-	A	A	A	A
Nominal heat input (Qn)	kW	12,0	23,7	26,4	30,4
Reduced heat input (Qr)	kW	2,0	3,0	3,3	4,2
Nominal heat output (80-60°C) (Pn)	kW	11,7	23,0	25,5	29,4
Reduced heat output (80-60°C) (Pr)	kW	1,8	2,6	3,0	3,9
Heat output (50-30°C)	kW	12,6	25,0	28,0	32,3
Reduced heat output (50-30°C)	kW	2,1	3,2	3,5	4,4
Useful efficiency at nominal input (80-60°C)	%	97,1	96,8	96,7	96,8
Useful efficiency at nominal input (50-30°C)	%	105,1	105,6	106,0	106,2
Useful efficiency at 30% (30°C return)	%	106,0	107,4	107,4	108,3
Heating circuit working pressure (min-max)	bar	0,5-3,0	0,5-3,0	0,5-3,0	0,5-3,0
CH temperature setting range	°C	20-78	20-78	20-78	20-78
CH maximum working temperature	°C	83	83	83	83
Heating expansion vessel capacity	l	10	10	10	10
DHW nominal heat input	kW	18,0 (*)	27,3 (*)	30,4 (*)	34,5 (*)
DHW minimum heat input	kW	2,0 (*)	3,0 (*)	3,3 (*)	4,2 (*)
DHW temperature range	°C	35-65 (***)	35-65 (***)	35-65 (***)	35-65 (***)
DHW maximum working temperature	°C	65 (***)	65 (***)	65 (***)	65 (***)
NOx emission class	-	6	6	6	6
Casing heat loss with burner on at nominal heat input	%	0,40	0,44	1,04	0,87
Casing heat loss with burner off	%	0,53	0,21	0,20	0,19
Chimney heat loss with burner on at nominal heat input	%	2,50	2,72	2,26	2,33
Air-flue ΔT at nominal heat input	°C	57,9	61	60	60
Flue gas flow at nominal heat input	g/s	8,25	12,43	13,93	15,81
CO2 at nominal heat input of heating (Natural gas)	%	9	9	9	9
CO2 at nominal heat input of heating (Propane)	%	10	10	10	10
Power supply voltage/frequency	V/Hz	230/50	230/50	230/50	230/50
Maximum power consumption	W	88	97	101	106
Circulation pump power input	W	50	50	50	50
Electric protection rating	IP	IPX5D	IPX5D	IPX5D	IPX5D
Air intake/flue gas vent pipe diameter	mm	80+80 60+60 100/60 125/80	80+80 60+60 100/60 125/80	80+80 60+60 100/60 125/80	80+80 60+60 100/60 125/80

(*) with optional hot water storage tank.

(***) with hot water storage tank probe connected.

TECHNICAL SPECIFICATIONS OF CONDENSING BOILERS

Technical data	um	Itaca	Itaca
Model	-	KB 24	KB 32
Type	-	B23-B23P-B33-C13-C33-C43-C53-C63-C83-C13X-C33X-C43X-C53X-C63X-C83X-C93	B23-B23P-B33-C13-C33-C43-C53-C63-C83-C13X-C33X-C43X-C53X-C63X-C83X-C93
Rated output (Pn)	kW	23	29
Seasonal energy efficiency of ambient heating (η_s)	%	92	93
Seasonal energy efficiency class of ambient heating	-	A	A
Stated load profile	-	XL	XL
Water heating energy efficiency (η_{wh})	%	82	80
Energy efficiency class of water heating	-	A	A
Nominal heat input (Qn)	kW	23,7	30,4
Reduced heat input (Qr)	kW	3,0	4,2
Nominal heat output (80-60°C) (Pn)	kW	23,0	29,4
Reduced heat output (80-60°C) (Pr)	kW	2,6	3,9
Heat output (50-30°C)	kW	25,0	32,3
Reduced heat output (50-30°C)	kW	3,2	4,4
Useful efficiency at nominal input (80-60°C)	%	96,8	96,2
Useful efficiency at nominal input (50-30°C)	%	105,6	106,2
Useful efficiency at 30% (30°C return)	%	107,4	108,3
Heating circuit working pressure (min-max)	bar	0,5-3,0	0,5-3,0
CH temperature setting range	°C	20-78	20-78
CH maximum working temperature	°C	83	83
Heating expansion vessel capacity	l	10	10
DHW nominal heat input	kW	27,3	34,5
DHW minimum heat input	kW	3,0	4,2
DHW nominal heat output (ΔT 30°C)	kW	26,8	33,4
DHW circuit working pressure (min-max)	bar	0,5-6,0	0,5-6,0
Specific DHW flow $\Delta T=30K$	l/min	16,2	19,5
Qualification of domestic hot water	-	***	***
DHW temperature range	°C	35-65	35-65
DHW maximum working temperature	°C	65	65
NOx emission class	-	6	6
Casing heat loss with burner on at nominal heat input	%	0,44	0,87
Casing heat loss with burner off	%	0,21	0,19
Chimney heat loss with burner on at nominal heat input	%	2,72	2,33
Air-flue ΔT at nominal heat input	°C	61	60
Flue gas flow at nominal heat input	g/s	12,43	15,81
CO2 at nominal heat input of heating (Natural gas)	%	9	9
CO2 at nominal heat input of heating (Propane)	%	10	10
Power supply voltage/frequency	V/Hz	230/50	230/50
Maximum power consumption	W	97	106
Circulation pump power input	W	50	50
Electric protection rating	IP	IPX4D	IPX4D
Air intake/flue gas vent pipe diameter	mm	80+80 60+60 100/60 125/80	80+80 60+60 100/60 125/80



TECHNICAL SPECIFICATIONS OF CONDENSING BOILERS

Technical data	um	Formentera	Formentera	Formentera	Formentera
Model	-	KC 12	KC 24	KC 28	KC 32
Type	-	B23-B23P-B33-C13-C33-C43-C53-C63-C83-C13X-C33X-C43X-C53X-C63X-C83X-C93-C93X	B23-B23P-B33-C13-C33-C43-C53-C63-C83-C13X-C33X-C43X-C53X-C63X-C83X-C93-C93X	B23-B23P-B33-C13-C33-C43-C53-C63-C83-C13X-C33X-C43X-C53X-C63X-C83X-C93-C93X	B23-B23P-B33-C13-C33-C43-C53-C63-C83-C13X-C33X-C43X-C53X-C63X-C83X-C93-C93X
Rated output (Pn)	kW	12	23	26	29
Seasonal energy efficiency of ambient heating (η_s)	%	90	92	92	93
Seasonal energy efficiency class of ambient heating	-	A	A	A	A
Stated load profile	-	M	XL	XL	XXL
Water heating energy efficiency (η_{wh})	%	77	85	86	87
Energy efficiency class of water heating	-	A	A	A	A
Nominal heat input (Qn)	kW	12,0	23,7	26,4	30,4
Reduced heat input (Qr)	kW	2,0	3,0	3,3	4,2
Nominal heat output (80-60°C) (Pn)	kW	11,7	23,0	25,5	29,4
Reduced heat output (80-60°C) (Pr)	kW	1,8	2,6	3,0	3,9
Heat output (50-30°C)	kW	12,6	25,0	28,0	32,3
Reduced heat output (50-30°C)	kW	2,1	3,2	3,5	4,4
Useful efficiency at nominal input (80-60°C)	%	97,1	96,8	96,7	96,8
Useful efficiency at nominal input (50-30°C)	%	105,1	105,6	106,0	106,2
Useful efficiency at 30% (30°C return)	%	106,0	107,4	107,4	108,3
Heating circuit working pressure (min-max)	bar	0,5-3,0	0,5-3,0	0,5-3,0	0,5-3,0
CH temperature setting range	°C	20-78	20-78	20-78	20-78
CH maximum working temperature	°C	83	83	83	83
Heating expansion vessel capacity	l	10	10	10	10
DHW nominal heat input	kW	18,0	27,3	30,4	34,5
DHW minimum heat input	kW	2,0	3,0	3,3	4,2
DHW nominal heat output (ΔT 30°C)	kW	18,6	27,4	29,2	33,4
DHW circuit working pressure (min-max)	bar	0,5-6,0	0,5-6,0	0,5-6,0	0,5-6,0
Specific DHW flow $\Delta T=30K$	l/min	8,8	13,4	15,5	16,2
Qualification of domestic hot water	-	**	**	**	**
DHW temperature range	°C	35-57	35-57	35-57	35-57
DHW maximum working temperature	°C	62	62	62	62
NOx emission class	-	6	6	6	6
Casing heat loss with burner on at nominal heat input	%	0,40	0,44	1,04	0,87
Casing heat loss with burner off	%	0,53	0,21	0,20	0,19
Chimney heat loss with burner on at nominal heat input	%	2,50	2,72	2,26	2,33
Air-flue ΔT at nominal heat input	°C	57,9	61	60	60
Flue gas flow at nominal heat input	g/s	8,25	12,43	13,93	15,81
CO2 at nominal heat input of heating (Natural gas)	%	9	9	9	9
CO2 at nominal heat input of heating (Propane)	%	10	10	10	10
Power supply voltage/frequency	V/Hz	230/50	230/50	230/50	230/50
Maximum power consumption	W	81	90	94	106
Circulation pump power input	W	43	43	43	50
Electric protection rating	IP	IPX5D	IPX5D	IPX5D	IPX5D
Air intake/flue gas vent pipe diameter	mm	80+80 60+60 100/60 125/80	80+80 60+60 100/60 125/80	80+80 60+60 100/60 125/80	80+80 60+60 100/60 125/80

TECHNICAL SPECIFICATIONS OF CONDENSING BOILERS

Technical data	um	Formentera	Formentera	Formentera	Formentera
Model	-	KR 12	KR 24	KR 28	KR 32
Type	-	B23-B23P-B33- C13-C33-C43- C53-C63-C83- C13X-C33X-C43X- C53X-C63X-C83X- C93-C93X	B23-B23P-B33- C13-C33-C43- C53-C63-C83- C13X-C33X-C43X- C53X-C63X-C83X- C93-C93X	B23-B23P-B33- C13-C33-C43- C53-C63-C83- C13X-C33X-C43X- C53X-C63X-C83X- C93-C93X	B23-B23P-B33- C13-C33-C43- C53-C63-C83- C13X-C33X-C43X- C53X-C63X-C83X- C93-C93X
Rated output (Pn)	kW	12	23	26	29
Seasonal energy efficiency of ambient heating (η_s)	%	90	92	92	93
Seasonal energy efficiency class of ambient heating	-	A	A	A	A
Nominal heat input (Qn)	kW	12,0	23,7	26,4	30,4
Reduced heat input (Qr)	kW	2,0	3,0	3,3	4,2
Nominal heat output (80-60°C) (Pn)	kW	11,7	23,0	25,5	29,4
Reduced heat output (80-60°C) (Pr)	kW	1,8	2,6	3,0	3,9
Heat output (50-30°C)	kW	12,6	25,0	28,0	32,3
Reduced heat output (50-30°C)	kW	2,1	3,2	3,5	4,4
Useful efficiency at nominal input (80-60°C)	%	97,1	96,8	96,7	96,8
Useful efficiency at nominal input (50-30°C)	%	105,1	105,6	106,0	106,2
Useful efficiency at 30% (30°C return)	%	106,0	107,4	107,4	108,3
Heating circuit working pressure (min-max)	bar	0,5-3,0	0,5-3,0	0,5-3,0	0,5-3,0
CH temperature setting range	°C	20-78	20-78	20-78	20-78
CH maximum working temperature	°C	83	83	83	83
Heating expansion vessel capacity	l	10	10	10	10
DHW nominal heat input	kW	18,0 (*)	27,3 (*)	30,4 (*)	34,5 (*)
DHW minimum heat input	kW	2,0 (*)	3,0 (*)	3,3 (*)	4,2 (*)
DHW temperature range	°C	35-65 (***)	35-65 (***)	35-65 (***)	35-65 (***)
DHW maximum working temperature	°C	65 (***)	65 (***)	65 (***)	65 (***)
NOx emission class	-	6	6	6	6
Casing heat loss with burner on at nominal heat input	%	0,40	0,44	1,04	0,87
Casing heat loss with burner off	%	0,53	0,21	0,20	0,19
Chimney heat loss with burner on at nominal heat input	%	2,50	2,72	2,26	2,33
Air-flue ΔT at nominal heat input	°C	57,9	61	60	60
Flue gas flow at nominal heat input	g/s	8,25	12,43	13,93	15,81
CO2 at nominal heat input of heating (Natural gas)	%	9	9	9	9
CO2 at nominal heat input of heating (Propane)	%	10	10	10	10
Power supply voltage/frequency	V/Hz	230/50	230/50	230/50	230/50
Maximum power consumption	W	81	90	94	106
Circulation pump power input	W	43	43	43	50
Electric protection rating	IP	IPX5D	IPX5D	IPX5D	IPX5D
Air intake/flue gas vent pipe diameter	mm	80+80 60+60 100/60 125/80	80+80 60+60 100/60 125/80	80+80 60+60 100/60 125/80	80+80 60+60 100/60 125/80

(*) with optional hot water storage tank.

(***) with hot water storage tank probe connected.

TECHNICAL SPECIFICATIONS OF CONDENSING BOILERS

Technical data	um	Formentera	Formentera	Formentera	Formentera
Model	-	KRB 12	KRB 24	KRB 28	KRB 32
Type	-	B23-B23P-B33-C13-C33-C43-C53-C63-C83-C13X-C33X-C43X-C53X-C63X-C83X-C93-C93X	B23-B23P-B33-C13-C33-C43-C53-C63-C83-C13X-C33X-C43X-C53X-C63X-C83X-C93-C93X	B23-B23P-B33-C13-C33-C43-C53-C63-C83-C13X-C33X-C43X-C53X-C63X-C83X-C93-C93X	B23-B23P-B33-C13-C33-C43-C53-C63-C83-C13X-C33X-C43X-C53X-C63X-C83X-C93-C93X
Rated output (Pn)	kW	12	23	26	29
Seasonal energy efficiency of ambient heating (η_s)	%	90	92	92	93
Seasonal energy efficiency class of ambient heating	-	A	A	A	A
Nominal heat input (Qn)	kW	12,0	23,7	26,4	30,4
Reduced heat input (Qr)	kW	2,0	3,0	3,3	4,2
Nominal heat output (80-60°C) (Pn)	kW	11,7	23,0	25,5	29,4
Reduced heat output (80-60°C) (Pr)	kW	1,8	2,6	3,0	3,9
Heat output (50-30°C)	kW	12,6	25,0	28,0	32,3
Reduced heat output (50-30°C)	kW	2,1	3,2	3,5	4,4
Useful efficiency at nominal input (80-60°C)	%	97,1	96,8	96,7	96,8
Useful efficiency at nominal input (50-30°C)	%	105,1	105,6	106,0	106,2
Useful efficiency at 30% (30°C return)	%	106,0	107,4	107,4	108,3
Heating circuit working pressure (min-max)	bar	0,5-3,0	0,5-3,0	0,5-3,0	0,5-3,0
CH temperature setting range	°C	20-78	20-78	20-78	20-78
CH maximum working temperature	°C	83	83	83	83
Heating expansion vessel capacity	l	10	10	10	10
DHW nominal heat input	kW	18,0 (*)	27,3 (*)	30,4 (*)	34,5 (*)
DHW minimum heat input	kW	2,0 (*)	3,0 (*)	3,3 (*)	4,2 (*)
DHW temperature range	°C	35-65 (***)	35-65 (***)	35-65 (***)	35-65 (***)
DHW maximum working temperature	°C	65 (***)	65 (***)	65 (***)	65 (***)
NOx emission class	-	6	6	6	6
Casing heat loss with burner on at nominal heat input	%	0,40	0,44	1,04	0,87
Casing heat loss with burner off	%	0,53	0,21	0,20	0,19
Chimney heat loss with burner on at nominal heat input	%	2,50	2,72	2,26	2,33
Air-flue ΔT at nominal heat input	°C	57,9	61	60	60
Flue gas flow at nominal heat input	g/s	8,25	12,43	13,93	15,81
CO2 at nominal heat input of heating (Natural gas)	%	9	9	9	9
CO2 at nominal heat input of heating (Propane)	%	10	10	10	10
Power supply voltage/frequency	V/Hz	230/50	230/50	230/50	230/50
Maximum power consumption	W	81	90	94	106
Circulation pump power input	W	43	43	43	50
Electric protection rating	IP	IPX5D	IPX5D	IPX5D	IPX5D
Air intake/flue gas vent pipe diameter	mm	80+80 60+60 100/60 125/80	80+80 60+60 100/60 125/80	80+80 60+60 100/60 125/80	80+80 60+60 100/60 125/80

(*) with optional hot water storage tank.

(***) with hot water storage tank probe connected.

TECHNICAL SPECIFICATIONS OF CONDENSING BOILERS

Technical data	um	Antea Next	Antea Next	Antea Next
Model	-	KC 26	KC 30	KC 35
Type	-	B23-B23P- B33-C13- C33-C43- C53-C63- C83-C13X- C33X- C43X- C53X- C63X- C83X-C93- C93X	B23-B23P- B33-C13- C33-C43- C53-C63- C83-C13X- C33X- C43X- C53X- C63X- C83X-C93- C93X	B23-B23P- B33-C13- C33-C43- C53-C63- C83-C13X- C33X- C43X- C53X- C63X- C83X-C93- C93X
Rated output (Pn)	kW	23	26	30
Seasonal energy efficiency of ambient heating (η_s)	%	92	92	91
Seasonal energy efficiency class of ambient heating	-	A	A	A
Stated load profile	-	XL	XL	XL
Water heating energy efficiency (η_{wh})	%	84	84	85
Energy efficiency class of water heating	-	A	A	A
Nominal heat input (Qn)	kW	23,7	26,7	30,4
Reduced heat input (Qr)	kW	3,0	3,3	4,2
Nominal heat flow rate with 20%H2NG mixture ($Q_{n(20\%H_2)}$)	kW	22,4	25,3	28,8
Minimum low heat flow rate with 20%H2NG mixture	kW	2,8	3,1	4,0
Nominal heat output (80-60°C) (Pn)	kW	23,1	26,0	29,6
Reduced heat output (80-60°C) (Pr)	kW	2,8	3,1	3,8
Heat output (50-30°C)	kW	25,0	28,1	32,2
Reduced heat output (50-30°C)	kW	3,3	3,4	4,4
Useful efficiency at nominal input (80-60°C)	%	97,3	97,3	97,3
Useful efficiency at nominal input (50-30°C)	%	105,5	105,4	105,9
Useful efficiency at 30% (30°C return)	%	108,4	108,0	107,8
Heating circuit working pressure (min-max)	bar	0,5-3,0	0,5-3,0	0,5-3,0
CH temperature setting range	°C	20-78	20-78	20-78
CH maximum working temperature	°C	83	83	83
Heating expansion vessel capacity	l	9	9	9
DHW nominal heat input	kW	27,3	30,4	34,5
DHW minimum heat input	kW	3,0	3,3	4,2
Nominal heat flow rate in DHW with 20%H2NG mixture ($Q_{nw(20\%H_2)}$)	kW	25,9	28,8	32,7
Minimum heat flow rate in DHW with 20%H2NG mixture	kW	2,8	3,1	4,0
DHW nominal heat output (ΔT 30°C)	kW	26,6	29,6	33,6
DHW circuit working pressure (min-max)	bar	0,5-6,0	0,5-6,0	0,5-6,0
Specific DHW flow $\Delta T=30K$	l/min	13,4	15,0	17,3
Qualification of domestic hot water	-	**	**	**
DHW temperature range	°C	35-57	35-57	35-57
DHW maximum working temperature	°C	62	62	62
NOx emission class	-	6	6	6
Casing heat loss with burner on at nominal heat input	%	0,33	0,55	0,43
Casing heat loss with burner off	%	0,21	0,23	0,21
Chimney heat loss with burner on at nominal heat input	%	2,66	2,66	2,74
Air-flue ΔT at nominal heat input	°C	54	55	55
Flue gas flow at nominal heat input	g/s	12,2	13,5	15,4
CO2 at nominal heat input of heating (Natural gas)	%	9,3	9,3	9,3
CO2 at nominal heat input of heating (Propane)	%	10,6	10,6	10,6
Power supply voltage/frequency	V/Hz	230/50	230/50	230/50
Maximum power consumption	W	103	108	118
Circulation pump power input	W	43	43	50
Electric protection rating	IP	IPX5D	IPX5D	IPX5D
Air intake/flue gas vent pipe diameter	mm	80+80 60+60 100/60 125/80	80+80 60+60 100/60 125/80	80+80 60+60 100/60 125/80

(*) with optional hot water storage tank.

(**) with comfort function disabled.

(***) with hot water storage tank probe connected.

TECHNICAL SPECIFICATIONS OF CONDENSING BOILERS

Technical data	um	Antea Next	Antea Next	Antea Next	Antea Next
Model	-	KR 12	KR 24	KR 28	KR 32
Type	-	B23-B23P- B33-C13- C33-C43- C53-C63- C83-C13X- C33X- C43X- C53X- C63X- C83X-C93- C93X	B23-B23P- B33-C13- C33-C43- C53-C63- C83-C13X- C33X- C43X- C53X- C63X- C83X-C93- C93X	B23-B23P- B33-C13- C33-C43- C53-C63- C83-C13X- C33X- C43X- C53X- C63X- C83X-C93- C93X	B23-B23P- B33-C13- C33-C43- C53-C63- C83-C13X- C33X- C43X- C53X- C63X- C83X-C93- C93X
Rated output (Pn)	kW	12	23	26	30
Seasonal energy efficiency of ambient heating (η_s)	%	92	92	92	91
Seasonal energy efficiency class of ambient heating	-	A	A	A	A
Nominal heat input (Qn)	kW	12,0	23,7	26,7	30,4
Reduced heat input (Qr)	kW	2,0	3,0	3,3	4,2
Nominal heat flow rate with 20%H2NG mixture (Qn(20%H2))	kW	11,4	22,4	25,3	28,8
Minimum low heat flow rate with 20%H2NG mixture	kW	1,9	2,8	3,1	4,0
Nominal heat output (80-60°C) (Pn)	kW	11,8	23,1	26,0	29,6
Reduced heat output (80-60°C) (Pr)	kW	1,8	2,8	3,1	3,8
Heat output (50-30°C)	kW	12,9	25,0	28,1	32,2
Reduced heat output (50-30°C)	kW	2,1	3,3	3,4	4,4
Useful efficiency at nominal input (80-60°C)	%	98,0	97,3	97,3	97,3
Useful efficiency at nominal input (50-30°C)	%	107,5	105,5	105,4	105,9
Useful efficiency at 30% (30°C return)	%	108,3	108,4	108,0	107,8
Heating circuit working pressure (min-max)	bar	0,5-3,0	0,5-3,0	0,5-3,0	0,5-3,0
CH temperature setting range	°C	20-78	20-78	20-78	20-78
CH maximum working temperature	°C	83	83	83	83
Heating expansion vessel capacity	l	9	9	9	9
DHW nominal heat input	kW	18,0 (*)	27,3 (*)	30,4 (*)	34,5 (*)
DHW minimum heat input	kW	2,0 (*)	2,0 (*)	3,3 (*)	4,2 (*)
Nominal heat flow rate in DHW with 20%H2NG mixture (Qnw(20%H2))	kW	17,0	25,9	28,8	32,7
Minimum heat flow rate in DHW with 20%H2NG mixture	kW	1,9	2,8	3,1	4,0
DHW temperature range	°C	35-65 (***)	35-65 (***)	35-65 (***)	35-65 (***)
DHW maximum working temperature	°C	65 (***)	65 (***)	65 (***)	65 (***)
NOx emission class	-	6	6	6	6
Casing heat loss with burner on at nominal heat input	%	0,00	0,33	0,55	0,43
Casing heat loss with burner off	%	0,42	0,21	0,23	0,21
Chimney heat loss with burner on at nominal heat input	%	1,99	2,66	2,66	2,74
Air-flue ΔT at nominal heat input	°C	47,0	54	55	55
Flue gas flow at nominal heat input	g/s	8,0	12,2	13,5	15,4
CO2 at nominal heat input of heating (Natural gas)	%	9,3	9,3	9,3	9,3
CO2 at nominal heat input of heating (Propane)	%	10,2	10,6	10,6	10,6
Power supply voltage/frequency	V/Hz	230/50	230/50	230/50	230/50
Maximum power consumption	W	96	103	108	118
Circulation pump power input	W	43	43	43	50
Electric protection rating	IP	IPX5D	IPX5D	IPX5D	IPX5D
Air intake/flue gas vent pipe diameter	mm	80+80 60+60 100/60 125/80	80+80 60+60 100/60 125/80	80+80 60+60 100/60 125/80	80+80 60+60 100/60 125/80

(*) with optional hot water storage tank.

(**) with comfort function disabled.

(***) with hot water storage tank probe connected.

TECHNICAL SPECIFICATIONS OF CONDENSING BOILERS

Technical data	um	Antea Next	Antea Next	Antea Next	Antea Next
Model	-	KRB 12	KRB 24	KRB 28	KRB 32
Type	-	B23-B23P- B33-C13- C33-C43- C53-C63- C83-C13X- C33X- C43X- C53X- C63X- C83X-C93- C93X	B23-B23P- B33-C13- C33-C43- C53-C63- C83-C13X- C33X- C43X- C53X- C63X- C83X-C93- C93X	B23-B23P- B33-C13- C33-C43- C53-C63- C83-C13X- C33X- C43X- C53X- C63X- C83X-C93- C93X	B23-B23P- B33-C13- C33-C43- C53-C63- C83-C13X- C33X- C43X- C53X- C63X- C83X-C93- C93X
Rated output (Pn)	kW	12	23	26	30
Seasonal energy efficiency of ambient heating (η_s)	%	92	92	92	91
Seasonal energy efficiency class of ambient heating	-	A	A	A	A
Nominal heat input (Qn)	kW	12,0	23,7	26,7	30,4
Reduced heat input (Qr)	kW	2,0	3,0	3,3	4,2
Nominal heat flow rate with 20%H2NG mixture (Qn(20%H2))	kW	11,4	22,4	25,3	28,8
Minimum low heat flow rate with 20%H2NG mixture	kW	1,9	2,8	3,1	4,0
Nominal heat output (80-60°C) (Pn)	kW	11,8	23,1	26,0	29,6
Reduced heat output (80-60°C) (Pr)	kW	1,8	2,8	3,1	3,8
Heat output (50-30°C)	kW	12,9	25,0	28,1	32,2
Reduced heat output (50-30°C)	kW	2,1	3,3	3,4	4,4
Useful efficiency at nominal input (80-60°C)	%	98,0	97,3	97,3	97,3
Useful efficiency at nominal input (50-30°C)	%	107,5	105,5	105,4	105,9
Useful efficiency at 30% (30°C return)	%	108,3	108,4	108,0	107,8
Heating circuit working pressure (min-max)	bar	0,5-3,0	0,5-3,0	0,5-3,0	0,5-3,0
CH temperature setting range	°C	20-78	20-78	20-78	20-78
CH maximum working temperature	°C	83	83	83	83
Heating expansion vessel capacity	l	9	9	9	9
DHW nominal heat input	kW	18,0 (*)	27,3 (*)	30,4 (*)	34,5 (*)
DHW minimum heat input	kW	2,0 (*)	2,0 (*)	3,3 (*)	4,2 (*)
Nominal heat flow rate in DHW with 20%H2NG mixture (Qnw(20%H2))	kW	17,0	25,9	28,8	32,7
Minimum heat flow rate in DHW with 20%H2NG mixture	kW	1,9	2,8	3,1	4,0
DHW temperature range	°C	35-65 (***)	35-65 (***)	35-65 (***)	35-65 (***)
DHW maximum working temperature	°C	65 (***)	65 (***)	65 (***)	65 (***)
NOx emission class	-	6	6	6	6
Casing heat loss with burner on at nominal heat input	%	0,00	0,33	0,55	0,43
Casing heat loss with burner off	%	0,42	0,21	0,23	0,21
Chimney heat loss with burner on at nominal heat input	%	1,99	2,66	2,66	2,74
Air-flue ΔT at nominal heat input	°C	47,0	54	55	55
Flue gas flow at nominal heat input	g/s	8,0	12,2	13,5	15,4
CO2 at nominal heat input of heating (Natural gas)	%	9,3	9,3	9,3	9,3
CO2 at nominal heat input of heating (Propane)	%	10,2	10,6	10,6	10,6
Power supply voltage/frequency	V/Hz	230/50	230/50	230/50	230/50
Maximum power consumption	W	96	103	108	118
Circulation pump power input	W	43	43	43	50
Electric protection rating	IP	IPX5D	IPX5D	IPX5D	IPX5D
Air intake/flue gas vent pipe diameter	mm	80+80 60+60 100/60 125/80	80+80 60+60 100/60 125/80	80+80 60+60 100/60 125/80	80+80 60+60 100/60 125/80

(*) with optional hot water storage tank.

(**) with comfort function disabled.

(***) with hot water storage tank probe connected.

TECHNICAL SPECIFICATIONS OF CONDENSING BOILERS

Technical data	um	Antea	Antea	Antea
Model	-	KC 12	KC 24	KC 28
Type	-	B23-B23P- B33-C13- C33-C43- C53-C63- C83-C13X- C33X- C43X- C53X- C63X- C83X-C93- C93X	B23-B23P- B33-C13- C33-C43- C53-C63- C83-C13X- C33X- C43X- C53X- C63X- C83X-C93- C93X	B23-B23P- B33-C13- C33-C43- C53-C63- C83-C13X- C33X- C43X- C53X- C63X- C83X-C93- C93X
Rated output (Pn)	kW	12	23	26
Seasonal energy efficiency of ambient heating (η_s)	%	90	92	92
Seasonal energy efficiency class of ambient heating	-	A	A	A
Stated load profile	-	M	XL	XL
Water heating energy efficiency (η_{wh})	%	78	84	80
Energy efficiency class of water heating	-	A	A	A
Nominal heat input (Qn)	kW	12,0	23,7	26,4
Reduced heat input (Qr)	kW	2,0	3,0	3,3
Nominal heat output (80-60°C) (Pn)	kW	11,7	22,8	25,5
Reduced heat output (80-60°C) (Pr)	kW	1,8	2,8	3,1
Heat output (50-30°C)	kW	12,6	24,9	28,0
Reduced heat output (50-30°C)	kW	2,1	3,2	3,5
Useful efficiency at nominal input (80-60°C)	%	97,1	96,3	96,7
Useful efficiency at nominal input (50-30°C)	%	105,1	105,1	105,9
Useful efficiency at 30% (30°C return)	%	106,0	107,2	107,5
Heating circuit working pressure (min-max)	bar	0,5-3,0	0,5-3,0	0,5-3,0
CH temperature setting range	°C	20-78	20-78	20-78
CH maximum working temperature	°C	83	83	83
Heating expansion vessel capacity	l	9	9	9
DHW nominal heat input	kW	18,0	27,3	30,4
DHW minimum heat input	kW	2,0	3,0	3,3
DHW nominal heat output (ΔT 30°C)	kW	18,4	27,4	29,2
DHW circuit working pressure (min-max)	bar	0,5-6,0	0,5-6,0	0,5-6,0
Specific DHW flow $\Delta T=30K$	l/min	8,6	13,4	15,0
Qualification of domestic hot water	-	**	**	**
DHW temperature range	°C	35-57	35-57	35-57
DHW maximum working temperature	°C	62	62	62
NOx emission class	-	6	6	6
Casing heat loss with burner on at nominal heat input	%	0,26	1,28	1,11
Casing heat loss with burner off	%	0,55	0,26	0,27
Chimney heat loss with burner on at nominal heat input	%	2,64	2,45	2,19
Air-flue ΔT at nominal heat input	°C	57,9	61	60
Flue gas flow at nominal heat input	g/s	8,25	12,43	13,93
CO2 at nominal heat input of heating (Natural gas)	%	9	9	9
CO2 at nominal heat input of heating (Propane)	%	10	10	10
Power supply voltage/frequency	V/Hz	230/50	230/50	230/50
Maximum power consumption	W	81	90	94
Circulation pump power input	W	43	43	43
Electric protection rating	IP	IPX4D	IPX4D	IPX4D
Air intake/flue gas vent pipe diameter	mm	80+80 60+60 100/60 125/80	80+80 60+60 100/60 125/80	80+80 60+60 100/60 125/80

TECHNICAL SPECIFICATIONS OF CONDENSING BOILERS

Technical data	um	Antea	Antea	Antea
Model	-	KR 12	KR 24	KR 28
Type	-	B23-B23P-B33- C13-C33-C43- C53-C63-C83- C13X-C33X-C43X- C53X-C63X-C83X- C93-C93X	B23-B23P-B33- C13-C33-C43- C53-C63-C83- C13X-C33X-C43X- C53X-C63X-C83X- C93-C93X	B23-B23P-B33- C13-C33-C43- C53-C63-C83- C13X-C33X-C43X- C53X-C63X-C83X- C93-C93X
Rated output (Pn)	kW	12	23	26
Seasonal energy efficiency of ambient heating (η_s)	%	90	92	92
Seasonal energy efficiency class of ambient heating	-	A	A	A
Nominal heat input (Qn)	kW	12,0	23,7	26,4
Reduced heat input (Qr)	kW	2,0	3,0	3,3
Nominal heat output (80-60°C) (Pn)	kW	11,7	22,8	25,5
Reduced heat output (80-60°C) (Pr)	kW	1,8	2,8	3,1
Heat output (50-30°C)	kW	12,6	24,9	28,0
Reduced heat output (50-30°C)	kW	2,1	3,2	3,5
Useful efficiency at nominal input (80-60°C)	%	97,1	96,3	96,7
Useful efficiency at nominal input (50-30°C)	%	105,1	105,1	105,9
Useful efficiency at 30% (30°C return)	%	106,0	107,2	107,5
Heating circuit working pressure (min-max)	bar	0,5-3,0	0,5-3,0	0,5-3,0
CH temperature setting range	°C	20-78	20-78	20-78
CH maximum working temperature	°C	83	83	83
Heating expansion vessel capacity	l	9	9	9
DHW nominal heat input	kW	18,0 (*)	27,3 (*)	30,4 (*)
DHW minimum heat input	kW	2,0 (*)	3,0 (*)	3,3 (*)
DHW temperature range	°C	35-65 (***)	35-65 (***)	35-65 (***)
DHW maximum working temperature	°C	65 (***)	65 (***)	65 (***)
NOx emission class	-	6	6	6
Casing heat loss with burner on at nominal heat input	%	0,26	1,28	1,11
Casing heat loss with burner off	%	0,55	0,26	0,27
Chimney heat loss with burner on at nominal heat input	%	2,64	2,45	2,19
Air-flue ΔT at nominal heat input	°C	57,9	61	60
Flue gas flow at nominal heat input	g/s	8,25	12,43	13,93
CO2 at nominal heat input of heating (Natural gas)	%	9	9	9
CO2 at nominal heat input of heating (Propane)	%	10	10	10
Power supply voltage/frequency	V/Hz	230/50	230/50	230/50
Maximum power consumption	W	81	90	94
Circulation pump power input	W	43	43	43
Electric protection rating	IP	IPX4D	IPX4D	IPX4D
Air intake/flue gas vent pipe diameter	mm	80+80 60+60 100/60 125/80	80+80 60+60 100/60 125/80	80+80 60+60 100/60 125/80

(*) with optional hot water storage tank.

(***) with hot water storage tank probe connected.

TECHNICAL SPECIFICATIONS OF CONDENSING BOILERS

Technical data	um	Antea	Antea	Antea
Model	-	KRB 12	KRB 24	KRB 28
Type	-	B23-B23P-B33-C13-C33-C43-C53-C63-C83-C13X-C33X-C43X-C53X-C63X-C83X-C93-C93X	B23-B23P-B33-C13-C33-C43-C53-C63-C83-C13X-C33X-C43X-C53X-C63X-C83X-C93-C93X	B23-B23P-B33-C13-C33-C43-C53-C63-C83-C13X-C33X-C43X-C53X-C63X-C83X-C93-C93X
Rated output (Pn)	kW	12	23	26
Seasonal energy efficiency of ambient heating (η_s)	%	90	92	92
Seasonal energy efficiency class of ambient heating	-	A	A	A
Nominal heat input (Qn)	kW	12,0	23,7	26,4
Reduced heat input (Qr)	kW	2,0	3,0	3,3
Nominal heat output (80-60°C) (Pn)	kW	11,7	22,8	25,5
Reduced heat output (80-60°C) (Pr)	kW	1,8	2,8	3,1
Heat output (50-30°C)	kW	12,6	24,9	28,0
Reduced heat output (50-30°C)	kW	2,1	3,2	3,5
Useful efficiency at nominal input (80-60°C)	%	97,1	96,3	96,7
Useful efficiency at nominal input (50-30°C)	%	105,1	105,1	105,9
Useful efficiency at 30% (30°C return)	%	106,0	107,2	107,5
Heating circuit working pressure (min-max)	bar	0,5-3,0	0,5-3,0	0,5-3,0
CH temperature setting range	°C	20-78	20-78	20-78
CH maximum working temperature	°C	83	83	83
Heating expansion vessel capacity	l	9	9	9
DHW nominal heat input	kW	18,0 (*)	27,3 (*)	30,4 (*)
DHW minimum heat input	kW	2,0 (*)	3,0 (*)	3,3 (*)
DHW temperature range	°C	35-65 (***)	35-65 (***)	35-65 (***)
DHW maximum working temperature	°C	65 (***)	65 (***)	65 (***)
NOx emission class	-	6	6	6
Casing heat loss with burner on at nominal heat input	%	0,26	1,28	1,11
Casing heat loss with burner off	%	0,55	0,26	0,27
Chimney heat loss with burner on at nominal heat input	%	2,64	2,45	2,19
Air-flue ΔT at nominal heat input	°C	57,9	61	60
Flue gas flow at nominal heat input	g/s	8,25	12,43	13,93
CO2 at nominal heat input of heating (Natural gas)	%	9	9	9
CO2 at nominal heat input of heating (Propane)	%	10	10	10
Power supply voltage/frequency	V/Hz	230/50	230/50	230/50
Maximum power consumption	W	81	90	94
Circulation pump power input	W	43	43	43
Electric protection rating	IP	IPX4D	IPX4D	IPX4D
Air intake/flue gas vent pipe diameter	mm	80+80 60+60 100/60 125/80	80+80 60+60 100/60 125/80	80+80 60+60 100/60 125/80

(*) with optional hot water storage tank.

(***) with hot water storage tank probe connected.

TECHNICAL SPECIFICATIONS OF CONDENSING BOILERS

Technical data	um	Tenerife
Model	-	KC 24
Type	-	B23-B23P-B33-C13-C13X-C33-C33X-C43-C43X-C53-C53X-C63-C63X-C83-C83X
Rated output (Pn)	kW	19
Seasonal energy efficiency of ambient heating (η_s)	%	92
Seasonal energy efficiency class of ambient heating	-	A
Stated load profile	-	XL
Water heating energy efficiency (η_{wh})	%	84
Energy efficiency class of water heating	-	A
Nominal heat input (Qn)	kW	20,0
Reduced heat input (Qr)	kW	5,0
Nominal heat output (80-60°C) (Pn)	kW	19,4
Reduced heat output (80-60°C) (Pr)	kW	4,8
Heat output (50-30°C)	kW	21,2
Reduced heat output (50-30°C)	kW	5,4
Useful efficiency at nominal input (80-60°C)	%	97,1
Useful efficiency at nominal input (50-30°C)	%	106,1
Useful efficiency at 30% (30°C return)	%	108,1
Heating circuit working pressure (min-max)	bar	0,5-3,0
CH temperature setting range	°C	20-78
CH maximum working temperature	°C	83
Heating expansion vessel capacity	l	9
DHW nominal heat input	kW	24,0
DHW minimum heat input	kW	5,0
DHW nominal heat output (ΔT 30°C)	kW	23,3
DHW circuit working pressure (min-max)	bar	0,5-6,0
Specific DHW flow $\Delta T=30K$	l/min	12,0
Qualification of domestic hot water	-	**
DHW temperature range	°C	35-57
DHW maximum working temperature	°C	62
NOx emission class	-	6
Casing heat loss with burner on at nominal heat input	%	0,16
Casing heat loss with burner off	%	0,38
Chimney heat loss with burner on at nominal heat input	%	2,79
Air-flue ΔT at nominal heat input	°C	73,3
Flue gas flow at nominal heat input	g/s	11,0
CO2 at nominal heat input of heating (Natural gas)	%	9,0 \pm 0,3
CO2 at nominal heat input of heating (Propane)	%	10,0 \pm 0,3
Power supply voltage/frequency	V/Hz	230/50
Maximum power consumption	W	104
Circulation pump power input	W	43
Electric protection rating	IP	IPX4D
Air intake/flue gas vent pipe diameter	mm	80+80 60+60 100/60 125/80



TECHNICAL SPECIFICATIONS OF CONDENSING BOILERS

Technical data	um	Itaca	Itaca	Itaca	Itaca	Itaca
Model	-	CH KR 45	CH KR 60	CH KR 85	CH KR 120	CH KR 150
Type	-	C13-C33-C43-C53-C63-C83-C93-C13X-C33X-C43X-C63X-C93X-B23-B23P-C(10)-C(11)	C13-C33-C43-C53-C63-C83-C93-C13X-C33X-C43X-C63X-C93X-B23-B23P-C(10)-C(11)	C13-C33-C43-C53-C63-C83-C93-C13X-C33X-C43X-C63X-C93X-B23-B23P-C(10)-C(11)	C13-C33-C43-C53-C63-C83-C93-C13X-C33X-C43X-C63X-C93X-B23-B23P-C(10)-C(11)	C13-C33-C43-C53-C63-C83-C93-C13X-C33X-C43X-C63X-C93X-B23-B23P-C(10)-C(11)
Rated output (Pn)	kW	39	58	79	112	136
Seasonal energy efficiency of ambient heating (η_s)	%	92	93	93	93	93
Seasonal energy efficiency class of ambient heating	-	A	A	-	-	-
Nominal heat input (Qn)	kW	40,0	60,0	81,0	115,0	140,0
Reduced heat input (Qr)	kW	4,0	6,0	9,0	11,5	22,5
Nominal heat output (80-60°C) (Pn)	kW	38,5	58,3	78,5	112,0	136,3
Reduced heat output (80-60°C) (Pr)	kW	3,8	5,8	8,5	11,1	21,6
Heat output (50-30°C)	kW	41,5	62,8	84,8	122,0	148,7
Reduced heat output (50-30°C)	kW	4,3	6,5	9,7	12,4	23,9
Useful efficiency at nominal input (80-60°C)	%	97,1	97,1	96,9	97,4	97,3
Useful efficiency at nominal input (50-30°C)	%	105,3	104,6	104,8	106,1	106,2
Useful efficiency at 30% (30°C return)	%	108,2	108,4	108,3	108,6	108,4
CH temperature setting range	°C	20-80	20-80	20-80	20-80	20-80
CH maximum working temperature	°C	83	83	83	83	83
NOx emission class	-	6	6	6	6	6
Casing heat loss with burner on at nominal heat input	%	0,15	0,25	1,12	0,6	0,76
Casing heat loss with burner off	%	0,21	0,17	0,141	0,084	0,09
Chimney heat loss with burner on at nominal heat input	%	2,80	2,65	2,8	2,59	2,34
Air-flue ΔT at nominal heat input	°C	57	57	45,3	54	52,6
Flue gas flow at nominal heat input	g/s	18,98	27,25	37,2	52,7	64,2
CO2 at nominal heat input of heating (Natural gas)	%	9,2	9,1	9	9	9
CO2 at nominal heat input of heating (Propane)	%	10,3	10,3	10	10,2	10,2
Power supply voltage/frequency	V/Hz	230/50	230/50	230/50	230/50	230/50
Maximum power consumption	W	94	119	156	251	310
Electric protection rating	IP	IPX4D	IPX4D	IPX4D	IPX4D	IPX4D
Air intake/flue gas vent pipe diameter	mm	80+80 80/125	80+80 80/125	80+80 80/125	100+100 100/150	100+100 100/150
Water content	l	2,2	3,3	4,3	6,7	9,2

TECHNICAL SPECIFICATIONS OF CONDENSING BOILERS

Technical data	um	Giava	Giava	Giava	Giava
Model	-	KRB 12	KRB 24	KRB 28	KRB 32
Type	-	B23-B23P-B33- C13-C33-C43- C53-C63-C83- C13X-C33X-C43X- C53X-C63X-C83X- C93-C93X	B23-B23P-B33- C13-C33-C43- C53-C63-C83- C13X-C33X-C43X- C53X-C63X-C83X- C93-C93X	B23-B23P-B33- C13-C33-C43- C53-C63-C83- C13X-C33X-C43X- C53X-C63X-C83X- C93-C93X	B23-B23P-B33- C13-C33-C43- C53-C63-C83- C13X-C33X-C43X- C53X-C63X-C83X- C93-C93X
Rated output (Pn)	kW	12	23	25	29
Seasonal energy efficiency of ambient heating (η_s)	%	90	91	91	92
Seasonal energy efficiency of ambient heating (η_s) V version	%	90	91	91	91
Seasonal energy efficiency of ambient heating (η_s) Z version	%	90	91	91	91
Seasonal energy efficiency class of ambient heating	-	A	A	A	A
Stated load profile	-	XL	XL	XL	XL
Water heating energy efficiency (η_{wh})	%	83	80	82	81
Water heating energy efficiency (η_{wh}) V version	%	83	80	82	81
Water heating energy efficiency (η_{wh}) Z version	%	83	80	82	80
Energy efficiency class of water heating	-	A	A	A	A
Nominal heat input (Qn)	kW	12,0	23,7	26,4	30,4
Reduced heat input (Qr)	kW	2,0	3,0	3,3	4,2
Nominal heat output (80-60°C) (Pn)	kW	11,6	22,9	25,4	29,4
Reduced heat output (80-60°C) (Pr)	kW	1,8	2,7	3,0	3,9
Heat output (50-30°C)	kW	12,6	24,9	27,9	32,3
Reduced heat output (50-30°C)	kW	2,1	3,22	3,58	4,4
Useful efficiency at nominal input (80-60°C)	%	97,1	96,7	96,4	96,8
Useful efficiency at nominal input (50-30°C)	%	105,1	105,1	105,5	106,2
Useful efficiency at 30% (30°C return)	%	106,0	106,5	107,0	108,3
Heating circuit working pressure (min-max)	bar	0,5-3,0	0,5-3,0	0,5-3,0	0,5-3,0
CH temperature setting range	°C	20-78	20-78	20-78	20-78
CH maximum working temperature	°C	83	83	83	83
Heating expansion vessel capacity	l	10	10	10	10
DHW expansion vessel capacity	l	5	5	5	5
DHW nominal heat input	kW	18,0	27,3	30,4	34,5
DHW minimum heat input	kW	2,0	3,0	3,3	4,2
DHW nominal heat output (ΔT 30°C)	kW	17,5	26,8	29,3	33,4
DHW circuit working pressure (min-max)	bar	0,5-6,0	0,5-6,0	0,5-6,0	0,5-6,0
Specific DHW flow $\Delta T=30K$	l/min	19,5	22	22,5	23,4
Qualification of domestic hot water	-	***	***	***	***
DHW temperature range	°C	35-65	35-65	35-65	35-65
DHW maximum working temperature	°C	65	65	65	65
NOx emission class	-	6	6	6	6
Casing heat loss with burner on at nominal heat input	%	0,40	0,61	1,13	0,87
Casing heat loss with burner off	%	0,53	0,21	0,2	0,19
Chimney heat loss with burner on at nominal heat input	%	2,50	2,69	2,47	2,33
Air-flue ΔT at nominal heat input	°C	57,9	61	60	60
Flue gas flow at nominal heat input	g/s	8,25	12,43	13,93	15,81
CO2 at nominal heat input of heating (Natural gas)	%	9	9	9	9
CO2 at nominal heat input of heating (Propane)	%	10	10	10	10
Power supply voltage/frequency	V/Hz	230/50	230/50	230/50	230/50
Maximum power consumption	W	88	97	101	106
Maximum power absorption - version V	W	176	185	189	194
Maximum power absorption - version Z	W	224	233	237	242
Circulation pump power input	W	50	50	50	50
Power absorption of circulation pumps in the V version	W	245	245	245	245
Power absorption of circulation pumps in the Z version	W	343	343	343	343
Electric protection rating	IP	IPX5D	IPX5D	IPX5D	IPX5D
Air intake/flue gas vent pipe diameter	mm	80+80 60+60 100/60 125/80	80+80 60+60 100/60 125/80	80+80 60+60 100/60 125/80	80+80 60+60 100/60 125/80

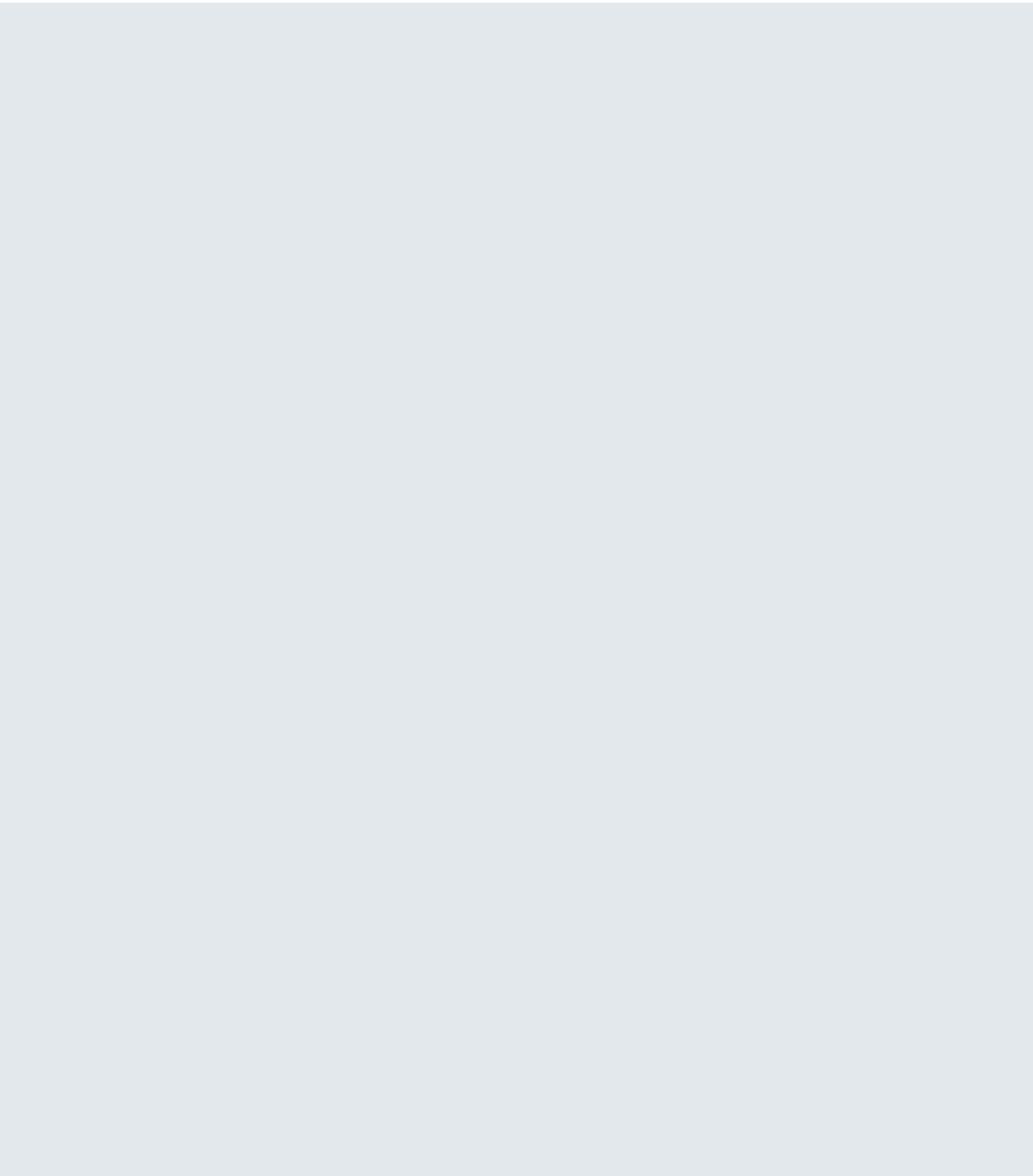



STANDARD BOILERS

WALL-HUNG BOILERS <35KW

FORMENTERA PRO CTN

page 82

ANTEA PRO CTN

page 84

TECHNICAL SPECIFICATIONS OF STANDARD BOILERS

Technical specifications of standard boilers

page 86



FORMENTERA PRO CTN

WALL-HUNG GAS BOILER WITH OPEN CHAMBER AND NATURAL DRAUGHT WITH INSTANT DHW PRODUCTION AND LOW NOX EMISSIONS



- ▶ **Water-cooled hyper-stoichiometric atmospheric gas burner with low NOx emissions**
- ▶ **Controls to manage two different types of solar thermal systems fitted as standard**
- ▶ **Thermoregulation with external probe (optional)**
- ▶ **Multifunction relay for connection to systems with zone valves or to solar plant or to remote alarm signal**
- ▶ **Stainless steel 26-plate DHW heat exchanger**
- ▶ Mono-thermal primary heat exchanger
- ▶ Programmable parameters to adapt the boiler to the installation and alerts history
- ▶ Heating expansion vessel - 7 litres
- ▶ Automatic by-pass
- ▶ High-efficiency circulation pump with built-in air purging device
- ▶ Compatible with SPOT smart thermostat



TOUCH SCREEN INTERFACE

- ▶ DHW and heating temperature setting
- ▶ Operating mode setting
- ▶ Solar thermal systems status display

Available in the following models:



Model	Gas type	Code	Heat input		Energy efficiency class		W x H x D mm	Gross weight kg
			Nominal (Qn) kW	Nominal DHW kW	Room heating	Heating DHW		
PRO CTN 24	NATURAL GAS	KFNXX2CN24	25,5	25,5	C	B XL	420x750x315	35,5
	PROPANE	KFNXX6CN24						
PRO CTN 28	NATURAL GAS	KFNXX2CN28	29,5	29,5	C	B XL	420x750x315	36,0
	PROPANE	KFNXX6CN28						

DIMENSIONS AND CONNECTION CENTRE DISTANCES

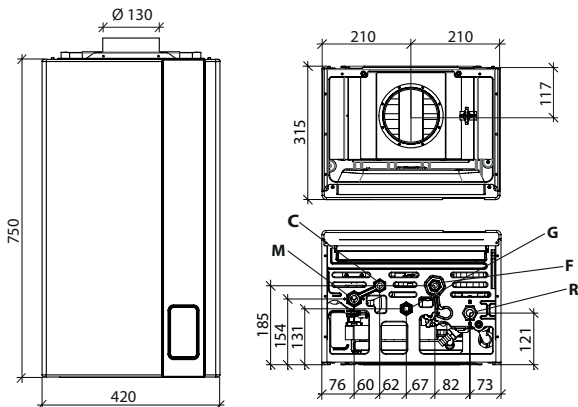









M CH system flow (3/4")
C DHW outlet (1/2")
G Gas inlet (1/2")

F Cold water inlet (1/2")
R CH system return (3/4")

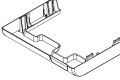

Technical data	um	PRO CTN 24	PRO CTN 28
Rated output (Pn)	kW	23	27
Seasonal energy efficiency of ambient heating (η_s)	%	80	79
Water heating energy efficiency (η_{wh})	%	76	74
Nominal heat input (Qn)	kW	25,5	29,5
Nominal heat output (80-60°C) (Pn)	kW	23,4	26,9
Reduced heat input (Qr)	kW	10,0	12,5
Useful efficiency at nominal input (80-60°C)	%	91,7	91,1
Useful efficiency at 30% (47°C return)	%	93,9	93,2
Heating expansion vessel capacity	l	7	7
DHW nominal heat input	kW	25,5	29,5
Specific DHW flow $\Delta T=30K$	l/min	11,3	12,5
NOx emission class	-	6	6
Electric protection rating	IP	X5D	X5D

For other technical specifications, see from page 86 - Maximum length of flue gas venting, see page 90

Item	Description	Code	Item	Description	Code
	Remote control, ErP V class (118x85x32 mm)	0CREMOTO04		Electrical kit for zone management with external probe	OKITZONE05
	Pipes and taps low plastic cover	0COPETUB03		Temperature probe for solar plants	PSPTMILL00
	Thermostat starter kit + Spot gateway	0SPOTAPP01		Magnetic dirt separator filter	0AFILDEF00
	Zone expansion for Spot thermostat	0EXPSPOT01		Kit for connection to solar plant	0KITSOLC07
	Flow - return cold water 90° taps kit	0KITIDBA11	For other accessories, see from page 89		



How to increase energy efficiency?

Discover the most suitable solution

Seasonal energy efficiency of ambient heating (η_s)				
Regulation device		Code	PRO CTN 24	PRO CTN 28
Option 1	Boiler + external probe	0SONDAES01	79%	78%
Option 2	Boiler + remote control	0CREMOTO04	80%	79%
Option 3	Boiler+ remote control + external probe	0SONDAES01	81%	80%
		0CREMOTO04		

ANTEA PRO CTN

WALL-HUNG GAS BOILER WITH OPEN CHAMBER AND NATURAL DRAUGHT WITH INSTANT DHW PRODUCTION AND LOW NOx EMISSIONS



- ▶ **Water-cooled hyper-stoichiometric atmospheric gas burner with low NOx emissions**
- ▶ **Compact dimension, only 250 mm deep**
- ▶ **LCD user interface with diagnostics**
- ▶ **Thermoregulation with external probe (optional)**
- ▶ **High-efficiency circulation pump with built-in air purging device**
- ▶ **Compatible with SPOT smart thermostat**
 -) Mono-thermal primary heat exchanger
 -) Heating expansion vessel - 7 litres
 -) Multifunction relay for connection to systems with zone valves or to external pump management or to remote alarm signal
 -) Stainless steel plate DHW heat exchanger
 -) Hydraulic unit in composite material
 -) Prearrangement for connection to Remote Control (optional, supplied by the manufacturer)
 -) Automatic by-pass

Available in the following models:

24

Model	Gas type	Code	Heat input		Energy efficiency class		W x H x D	Gross weight
			Nominal (Qn) kW	Nominal DHW kW	Room heating	Heating DHW	mm	kg
PRO CTN 24	NATURAL GAS	KAHXX2CN24	24,5	24,5	C	B XL	400x700x250	25,5
	PROPANE	KAHXX6CN24						

DIMENSIONS AND CONNECTION CENTRE DISTANCES

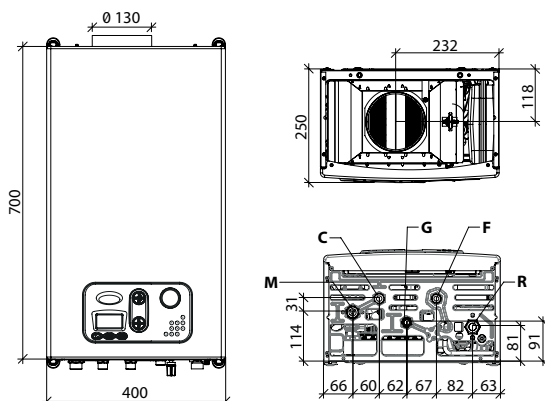

M CH system flow (3/4")
C DHW outlet (1 1/2")
G Gas inlet (1/2")

F Cold water inlet (1/2")
R CH system return (3/4")



Technical data	um	PRO CTN 24
Rated output (Pn)	kW	22
Seasonal energy efficiency of ambient heating (η_s)	%	80
Water heating energy efficiency (η_{wh})	%	77
Nominal heat input (Qn)	kW	24,5
Nominal heat output (80-60°C) (Pn)	kW	22,3
Reduced heat input (Qr)	kW	12,0
Useful efficiency at nominal input (80-60°C)	%	91,2
Useful efficiency at 30% (47°C return)	%	93,2
Heating expansion vessel capacity	l	7
DHW nominal heat input	kW	24,5
Specific DHW flow $\Delta T=30K$	l/min	9,3
NOx emission class	-	6
Electric protection rating	IP	X4D

For other technical specifications, see from page 87 - Maximum length of flue gas venting, see page 90

Item	Description	Code
	Compact wall pipe cover - Height 110 mm - Width 400 mm - Depth (upper part) 194 mm - Depth (lower part) 165 mm	0COPETUB00
	Remote control, ErP V class (118x85x32 mm)	0CREMOTO04
	Thermostat starter kit + Spot gateway	0SPOTAPP01
	Zone expansion for Spot thermostat	0EXPSPOT01
	Electrical kit for zone management with external probe	0KITZONE05
	External probe (60x45x31 mm)	0SONDAES01

Item	Description	Code
	Magnetic dirt separator filter	0AFILDEF00
	Basic hydraulic kit	0KITIDBA29
	Flow - return cold water 90° taps kit	0KITIDBA11
	Plus hydr. kit for basic compact unit	0KITIDBA14
	Kit for connection to solar plant	0KITSOLC07

For other accessories, see from page 89



How to increase energy efficiency?

Discover the most suitable solution

Seasonal energy efficiency of ambient heating (η_s)			
Regulation device	Code	PRO CTN 24	
Option 1	Boiler + external probe	0SONDAES01	78%
Option 2	Boiler + remote control	0CREMOTO04	79%
Option 3	Boiler+ remote control + external probe	0SONDAES01	80%
		0CREMOTO04	

TECHNICAL SPECIFICATIONS OF STANDARD BOILERS

Technical data	um	Formentera	Formentera
Model	-	PRO CTN 24	PRO CTN 28
Type	-	B11BS	B11BS
Rated output (Pn)	kW	23	27
Seasonal energy efficiency of ambient heating (η_s)	%	80	79
Seasonal energy efficiency class of ambient heating	-	C	C
Stated load profile	-	XL	XL
Water heating energy efficiency (η_{wh})	%	76	74
Energy efficiency class of water heating	-	B	B
Nominal heat input (Qn)	kW	25,5	29,5
Reduced heat input (Qr)	kW	10,0	12,5
Nominal heat output (80-60°C) (Pn)	kW	23,4	26,9
Reduced heat output (80-60°C) (Pr)	kW	8,8	11,2
Useful efficiency at nominal input (80-60°C)	%	91,7	91,1
Useful efficiency at 30% (47°C return)	%	93,9	93,2
Heating circuit working pressure (min-max)	bar	0,5-3,0	0,5-3,0
CH temperature setting range	°C	35-78	35-78
CH maximum working temperature	°C	83	83
Heating expansion vessel capacity	l	7	7
DHW nominal heat input	kW	25,5	29,5
DHW minimum heat input	kW	10,0	12,5
DHW nominal heat output (ΔT 30°C)	kW	23,4	26,9
DHW minimum heat output (ΔT 30°C)	kW	8,8	11,2
DHW circuit working pressure (min-max)	bar	0,5-6,0	0,5-6,0
Specific DHW flow $\Delta T=30K$	l/min	11,3	12,5
DHW temperature range	°C	35-57	35-57
DHW maximum working temperature	°C	62	62
NOx emission class	-	6	6
Casing heat loss with burner on at nominal heat input	%	2,15	2,51
Casing heat loss with burner off	%	0,69	0,65
Chimney heat loss with burner on at nominal heat input	%	6,19	6,44
Air-flue ΔT at nominal heat input	°C	86	93
Flue gas flow at nominal heat input	g/s	18,9	20,1
CO2 at nominal heat input of heating (Natural gas)	%	5,3	5,8
CO2 at nominal heat input of heating (Propane)	%	6,6	6,0
Power supply voltage/frequency	V/Hz	230/50	230/50
Maximum power consumption	W	57	56
Circulation pump power input	W	41	41
Electric protection rating	IP	X5D	X5D
Flue gas discharge pipes diameter	mm	130	130

TECHNICAL SPECIFICATIONS OF STANDARD BOILERS

Technical data	um	Antea
Model	-	PRO CTN 24
Type	-	B11BS
Rated output (Pn)	kW	22
Seasonal energy efficiency of ambient heating (η_s)	%	80
Seasonal energy efficiency class of ambient heating	-	C
Stated load profile	-	XL
Water heating energy efficiency (η_{wh})	%	77
Energy efficiency class of water heating	-	B
Nominal heat input (Qn)	kW	24,5
Reduced heat input (Qr)	kW	12,0
Nominal heat output (80-60°C) (Pn)	kW	22,3
Reduced heat output (80-60°C) (Pr)	kW	10,8
Useful efficiency at nominal input (80-60°C)	%	91,2
Useful efficiency at 30% (47°C return)	%	93,2
Useful efficiency at reduced flow rate (80-60°C)	%	90,1
Heating circuit working pressure (min-max)	bar	0,5-3,0
CH temperature setting range	°C	35-78
CH maximum working temperature	°C	83
Heating expansion vessel capacity	l	7
DHW nominal heat input	kW	24,5
DHW minimum heat input	kW	12,0
DHW nominal heat output (ΔT 30°C)	kW	22,3
DHW minimum heat output (ΔT 30°C)	kW	10,8
DHW circuit working pressure (min-max)	bar	0,5-6,0
Specific DHW flow $\Delta T=30K$	l/min	9,3
DHW temperature range	°C	35-57
DHW maximum working temperature	°C	62
NOx emission class	-	6
Casing heat loss with burner on at nominal heat input	%	2,97
Casing heat loss with burner off	%	0,62
Chimney heat loss with burner on at nominal heat input	%	5,83
Air-flue ΔT at nominal heat input	°C	82
Flue gas flow at nominal heat input	g/s	16,7
CO2 at nominal heat input of heating (Natural gas)	%	5,8
CO2 at nominal heat input of heating (Propane)	%	6,6
Power supply voltage/frequency	V/Hz	230/50
Maximum power consumption	W	57
Circulation pump power input	W	41
Electric protection rating	IP	X4D
Flue gas discharge pipes diameter	mm	130





FLUE FITTINGS AND ACCESSORIES

FLUE FITTINGS

Discharge for condensing boilers type B23	page 90
Discharge for condensing boilers type C13	page 92
Discharge for condensing boilers type C33	page 93
Discharge for condensing boilers type C53	page 96
Discharge for standard boilers Type B22	page 98
Discharge for standard boilers Type C12	page 99
Discharge for standard boilers Type C32	page 100
Discharge for standard boilers Type C52	page 102
Concentric flue fittings for condensing boilers Ø 60/100	page 103
Concentric flue fittings for condensing boilers Ø 80/125	page 103
Concentric flue fittings for condensing boilers Ø 100/150	page 104
Split flue fittings for condensing boilers Ø 50	page 105
Split flue fittings for condensing boilers Ø 60	page 106
Split flue fittings for condensing boilers Ø 80	page 107
Split flue fittings for condensing boilers Ø 100	page 108
Fittings for modules flue gas collectors Ø 160	page 109
Fittings for modules flue gas collectors Ø 200	page 109
Fittings for modules flue gas collectors Ø 250	page 110

ACCESSORIES









Thermoregulation and electronic	page 111
Outdoor installation partially protected and optional accessories	page 113
Hydraulic	page 114



DISCHARGE FOR CONDENSING BOILERS TYPE B23

INTAKE AND VENT PIPES Ø 80











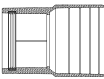
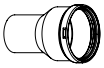

No.	Item	Description	Code
09		Splitter kit Ø80+80	0KITSDOP08
10		Extension M/F Ø80 L=1 m	0PROLUNG00
11		Extension M/F Ø80 L=0.5 m	0PROLUNG01
13		90° elbow M/F Ø80	0CURVAXX02
15		Suction opening Ø80	0GRIGASP01
16		Flue vent chimney Ø80 H=138cm	0CAMISCA00
18		Flue vent terminal Ø80 L=1m	0TERMSCA00
37		Tile for tilted roof (flue output)	0TEGTEIN00
43		Wall rosette in silicone, ID Ø80 OD Ø170	0ROSPAS100

DISCHARGE FOR CONDENSING BOILERS TYPE B23

INTAKE AND VENT PIPES Ø 80-60

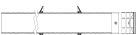



No.	Item	Description	Code
09		Splitter kit Ø80+80	OKITSDOP08
13		90° elbow M/F Ø80	0CURVAXX02
15		Suction opening Ø80	0GRIGASP01
16		Flue vent chimney Ø80 H=138cm	0CAMISCA00
24		Adapter Ø80/60	0RIDUZIO19
25		Adapter M/F Ø 60-80 M/F	0RIDUZIO10
28		90° elbow Ø60	0CURVAXX16
30		Extension M/F Ø60 L=1m	0PROLUNG16
32		Extension M/F Ø60 L=0.5 m	0PROLUNG18
36		Flue vent terminal Ø60 L=1m	0TERMSCA01
37		Tile for tilted roof (flue output)	0TEGTEIN00



DISCHARGE FOR CONDENSING BOILERS TYPE C13

INTAKE AND VENT PIPES Ø 60/100

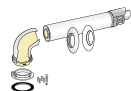

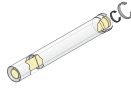
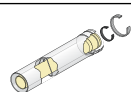





No.	Item	Description	Code
01		Coaxial kit Ø 60/100 length 75cm	0CONDASP00
02		Coaxial fitting kit Ø60/100	0KITATCO00
03		90° elbow M/F coaxial Ø60/100	0CURVAXX05
05		Coaxial extension M/F Ø60/100 L=1m	0PROLUNG02
06		Coaxial extension M/F Ø60/100 L=0.5m	0PROLUNG03

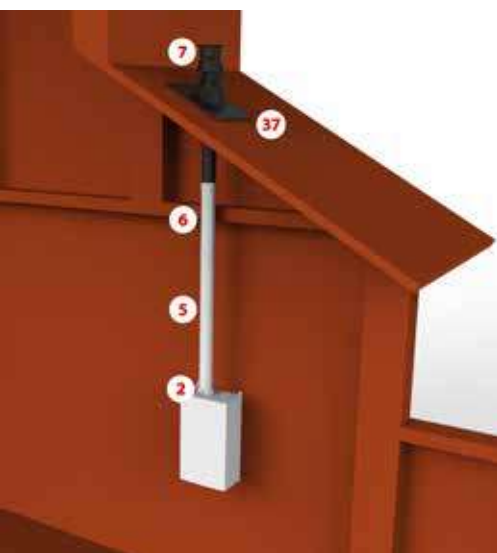
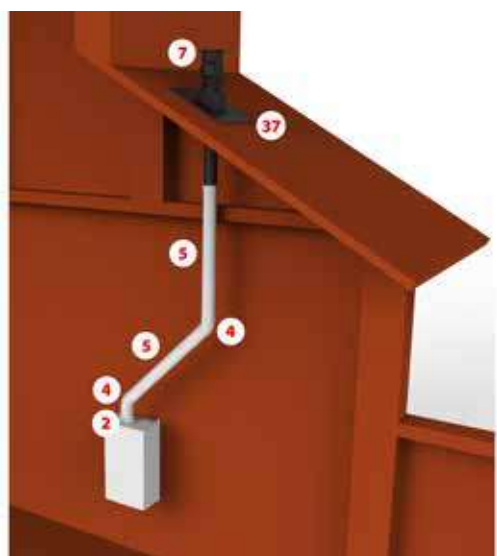
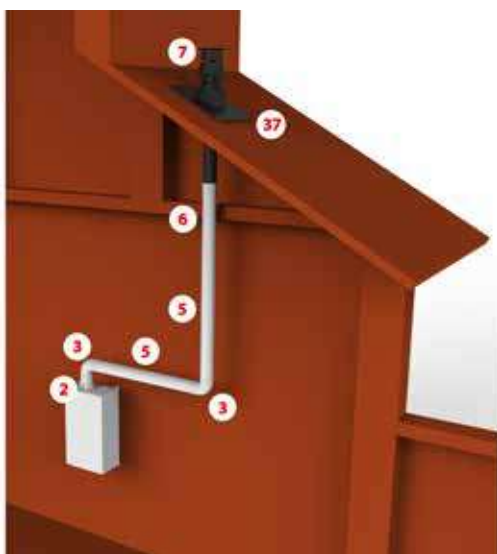

DISCHARGE FOR CONDENSING BOILERS TYPE C33

INTAKE AND VENT PIPES Ø 60/100

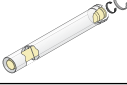
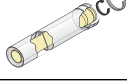
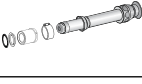









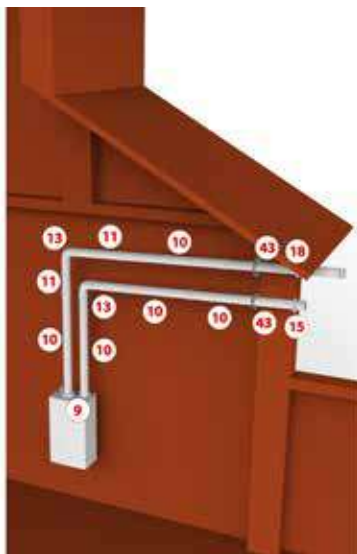

No.	Item	Description	Code
02		Coaxial fitting kit Ø60/100	OKITATCO00
03		90° elbow M/F coaxial Ø60/100	0CURVAXX05
04		45° elbow M/F coaxial Ø60/100	0CURVAXX04
05		Coaxial extension M/F Ø60/100 L=1m	0PROLUNG02
06		Coaxial extension M/F Ø60/100 L=0.5m	0PROLUNG03
07		Coaxial flue kit Ø60/100	OKCAMASP00
37		Tile for tilted roof (flue output)	0TEGTEIN00



DISCHARGE FOR CONDENSING BOILERS TYPE C33

INTAKE AND VENT PIPES Ø 80

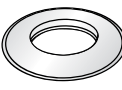

No.	Item	Description	Code
09		Splitter kit Ø80+80	0KITSDOP08
10		Extension M/F Ø80 L=1 m	0PROLUNG00
11		Extension M/F Ø80 L=0.5 m	0PROLUNG01
13		90° elbow M/F Ø80	0CURVAXX02
15		Suction opening Ø80	0GRIGASP01
17		Flue gas intake/vent chimney Ø80+80 H=138.4cm	0CAMIASP00
18		Flue vent terminal Ø80 L=1m	0TERMSCA00
19		Tee kit for visual inspection and collecting condensate Ø80	0KITRACT00
23		Tee M/M/F Ø80	0RACCORT00
37		Tile for tilted roof (flue output)	0TEGTEIN00
43		Wall rosette in silicone, ID Ø80 OD Ø170	0ROSPASI00

DISCHARGE FOR CONDENSING BOILERS TYPE C33

INTAKE AND VENT PIPES Ø 60

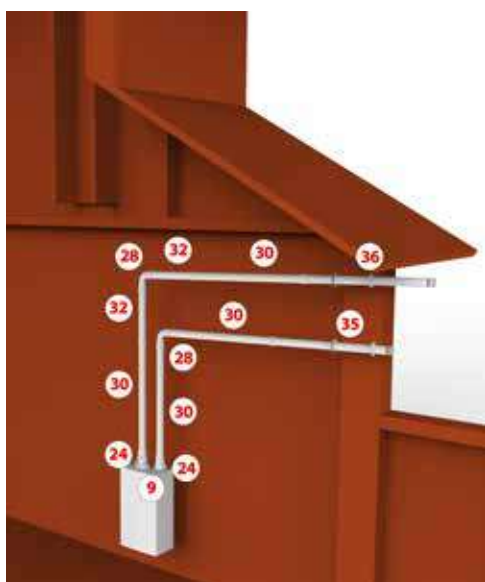















No.	Item	Description	Code
09		Splitter kit Ø80+80	OKITSDOP08
17		Flue gas intake/vent chimney Ø80+80 H=138.4cm	0CAMIASP00
24		Adapter Ø80/60	ORIDUZIO19
25		Adapter M/F Ø 60-80 M/F	ORIDUZIO10
28		90° elbow Ø60	0CURVAXX16
30		Extension M/F Ø60 L=1m	OPROLUNG16
31		Extension M/F Ø60 L=2 m	OPROLUNG17
32		Extension M/F Ø60 L=0.5 m	OPROLUNG18
33		Tee M/M/F Ø60	0RACCORT06
34		Condensate drain Ø60	0SCARCON03
35		Air intake terminal Ø60 L=1m	0TERMASP01
36		Flue vent terminal Ø60 L=1m	0TERMSCA01
37		Tile for tilted roof (flue output)	0TEGTEIN00



DISCHARGE FOR CONDENSING BOILERS TYPE C53

INTAKE AND VENT PIPES Ø 80









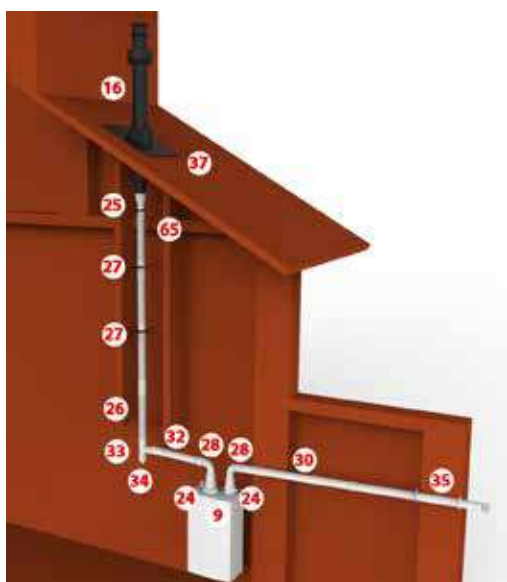



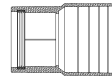
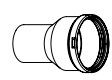

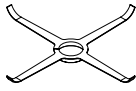
No.	Item	Description	Code
09		Splitter kit Ø80+80	0KITSDOP08
10		Extension M/F Ø80 L=1 m	0PROLUNG00
11		Extension M/F Ø80 L=0.5 m	0PROLUNG01
13		90° elbow M/F Ø80	0CURVAXX02
15		Suction opening Ø80	0GRIGASP01
16		Flue vent chimney Ø80 H=138cm	0CAMISCA00
18		Flue vent terminal Ø80 L=1m	0TERMSCA00
19		Tee kit for visual inspection and collecting condensate Ø80	0KITRACT00
20		Kit of adapters for flexible hose Ø80 (included gaskets)	0KADAFLE00
22		Centring element for flexible hose Ø80	0CENTFLE00
23		Tee M/M/F Ø80	0RACCORT00
37		Tile for tilted roof (flue output)	0TEGTEIN00
43		Wall rosette in silicone, ID Ø80 OD Ø170	0ROSPASI00
66		Flexible pipe M/F Ø80 (20m roll)	0TUBOFLE06

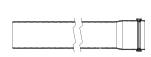
DISCHARGE FOR CONDENSING BOILERS TYPE C53

INTAKE AND VENT PIPES Ø 60

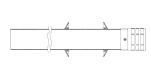
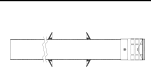











No.	Item	Description	Code
09		Splitter kit Ø80+80	0KITSDOP08
16		Flue vent chimney Ø80 H=138cm	0CAMISCA00
24		Adapter Ø80/60	0RIDUZIO19
25		Adapter M/F Ø 60-80 M/F	0RIDUZIO10
26		Kit of adapters for flexible hose Ø60	0KADAFLE01
27		Centring element for flexible hose Ø60	0CENTFLE02
28		90° elbow Ø60	0CURVAXX16
30		Extension M/F Ø60 L=1m	0PROLUNG16
31		Extension M/F Ø60 L=2 m	0PROLUNG17
32		Extension M/F Ø60 L=0.5 m	0PROLUNG18
33		Tee M/M/F Ø60	0RACCORT06
34		Condensate drain Ø60	0SCARCON03
35		Air intake terminal Ø60 L=1m	0TERMASP01
36		Flue vent terminal Ø60 L=1m	0TERMSCA01
37		Tile for tilted roof (flue output)	0TEGTEIN00
65		Flexible pipe M/F Ø60 (20m roll)	0TUBOFLE07



DISCHARGE FOR STANDARD BOILERS TYPE B22

INTAKE AND VENT PIPES Ø 80





No.	Item	Description	Code
15		Suction opening Ø80	0GRIGASP01
37		Tile for tilted roof (flue output)	0TEGTEIN00
38		Extension Ø80 L= 1m	0CONDOTT00
39		Ø80 pipe L= 0.5m (for TFS boilers)	0CONDOTT01
40A		Elbow 90° Ø80 broad beam	0CURREALA00
40B		90° elbow with inspection Ø80 narrow radius (for TFS boilers)	0CURVAXX03
43		Wall rosette in silicone, ID Ø80 OD Ø170	0ROSPASI00
84		Upwind terminal Ø80 stainless steel	0TERCOIN00
86		Horizontal chimney terminal D80	0TESTCAM00
153		Coaxial flue kit	0SDOPPIA13

DISCHARGE FOR STANDARD BOILERS TYPE C12

INTAKE AND VENT PIPES Ø 60/100

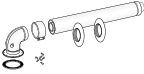
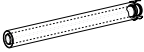







No.	Item	Description	Code
140		Coaxial kit D60/100 L=1m (for boiler TFS)	OKITCONC00
147		Concentric pipe length 1m D60/100 (for TFS boilers)	0TUBCOLU00
148		Concentric pipe length 0.5m D60/100 (for TFS boilers)	0TUBCOLU01

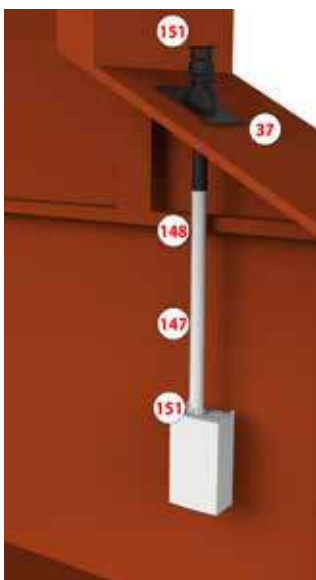

DISCHARGE FOR STANDARD BOILERS TYPE C32

INTAKE AND VENT PIPES Ø 60/100

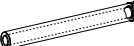











No.	Item	Description	Code
37		Tile for tilted roof (flue output)	0TEGTEIN00
78		Elbow 90° coaxial Ø100/60 (for boilers TFS)	0CURVCON00
79		Elbow 45° coaxial Ø100/60 (for boilers TFS)	0CURVCON01
147		Concentric pipe length 1m D60/100 (for TFS boilers)	0TUBCOLU00
148		Concentric pipe length 0.5m D60/100 (for TFS boilers)	0TUBCOLU01
151		Coaxial roof chimney Ø100/60 (for TFS boilers)	0SCATECO00

DISCHARGE FOR STANDARD BOILERS TYPE C32

INTAKE AND VENT PIPES Ø 80













No.	Item	Description	Code
15		Suction opening Ø80	0GRIGASP01
37		Tile for tilted roof (flue output)	0TEGTEIN00
38		Extension Ø80 L= 1m	0CONDOTT00
39		Ø80 pipe L= 0.5m (for TFS boilers)	0CONDOTT01
40A		Elbow 90° Ø80 broad beam	0CURRALA00
40B		90° elbow with inspection Ø80 narrow radius (for TFS boilers)	0CURVAXX03
43		Wall rosette in silicone, ID Ø80 OD Ø170	0ROSPASIO0
84		Upwind terminal Ø80 stainless steel	0TERCOIN00
149		Chimney for splitted pipes Ø80/80 (for boilers TFS)	0CAMCOSD00
153		Coaxial flue kit	0SDOPPIA13













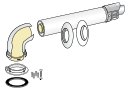
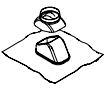

DISCHARGE FOR STANDARD BOILERS TYPE C52

INTAKE AND VENT PIPES Ø 80

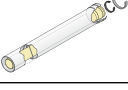

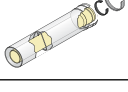

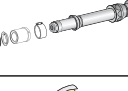









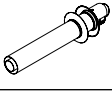

No.	Item	Description	Code
15		Suction opening Ø80	0GRIGASP01
37		Tile for tilted roof (flue output)	0TEGTEIN00
38		Extension Ø80 L= 1m	0CONDOTT00
39		Ø80 pipe L= 0.5m (for TFS boilers)	0CONDOTT01
40A		Elbow 90° Ø80 broad beam	0CURREALA00
40B		90° elbow with inspection Ø80 narrow radius (for TFS boilers)	0CURVAXX03
43		Wall rosette in silicone, ID Ø80 OD Ø170	0ROSPASI00
84		Upwind terminal Ø80 stainless steel	0TERCOIN00
86		Horizontal chimney terminal D80	0TESTCAM00
88		Vertical stub pipe with condensate trap Ø80 L=0.135m (for TFS boilers)	0TRONVER00
153		Coaxial flue kit	0SDOPPIA13















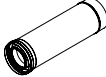

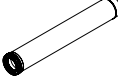
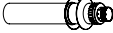
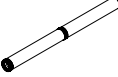
CONCENTRIC FLUE FITTINGS FOR CONDENSING BOILERS Ø 60/100

Item	Description	Code	Item	Description	Code
	Coaxial kit Ø 60/100 length 75cm	0CONDASP00		Tile for tilted roof (flue output)	0TEGTEIN00
	Coaxial fitting kit Ø60/100	0KITATCO00		Sealing collar kit D 100	0KCOLLBL00
	90° elbow M/F coaxial Ø60/100	0CURVAXX05		Concentric terminal 60/100	0TERMCON01
	45° elbow M/F coaxial Ø60/100	0CURVAXX04		Starting flange kit for condensing boilers	0KITFLAN00
	Coaxial extension M/F Ø60/100 L=1m	0PROLUNG02		Ducting plate kit Ø60/100	0PIASINT02
	Coaxial extension M/F Ø60/100 L=0.5m	0PROLUNG03		30° elbow M/F coaxial Ø60/100	0CURVAXX31
	Coaxial flue kit Ø60/100	0KCAMASP00		15° elbow M/F coaxial Ø60/100	0CURVAXX32
	Elbow 90° and flange kit Ø60/100	0KCURFLA00			

CONCENTRIC FLUE FITTINGS FOR CONDENSING BOILERS Ø 80/125











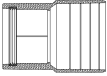

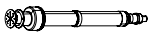
Item	Description	Code	Item	Description	Code
	Coax. adapter kit D.60/100 to D.80/125	0KITADCO00		Coaxial M-F 45° elbow D. 80/125	0CURVAXX06
	Intake/condensate drain kit	0KITASCA00		Coaxial M-F 90° elbow D. 80/125	0CURVAXX07
	80/125 straight intake/vent tailpipe kit	0KITASCA01		90° elbow for visual inspection D. 80/125	0CURVISP05
	Coaxial flue + flange kit	0KITCACO00		Extension for visual inspection d80/125	0TUBISPV05
	80/125 flue kit	0KITCACO01		Coaxial flue gases starting kit 125/80 (for boiler ITACA CH KR)	0ATTCOFL01
	Coax. extension D.80/125 L=1m	0PROLUNG04		80/125 pipework plate kit	0PIASINT01
	Coax. extension D.80/125 L=0.5m	0PROLUNG05		Sealing collar kit D 125	0KCOLLBL01

CONCENTRIC FLUE FITTINGS FOR CONDENSING BOILERS Ø 100/150

Item	Description	Code	Item	Description	Code
	150 / 100 concentric starter fitting kit	0ATTCOFL00		100/150 Tee fitting M/M/F 90° cap	0RACTTAP01
	100/150 coax. extension M/F L=250	0PROLUNG20		100/150 Coaxial fitting M/M/F outlets	0ATTCOVE07
	100/150 coax. extension M/F L=500	0PROLUNG21		100/150 Coaxial fitting M/M/F Pipe Fitting	0ATTCOVE08
	100/150 coax. extension M/F L=1000	0PROLUNG22		100/150 coaxial wall term.	0TERMPAR00
	100/150 coax. extension M/F L=2000	0PROLUNG23		Adapter kit from 80/125 to 100/150	0RIDUZIO22
	100/150 90° M/F elbow	0CURVAXX18		100/150 coaxial roof term.	0TERMTET00
	100/150 45° M/F elbow	0CURVAXX19		100/150 pipework plate kit	0PIASINT00
	100/150 coaxial 15° M/F elbow	0CURVAXX20		Sealing collar kit D 150	0KCOLLBL02
	100/150 coaxial 30° M/F elbow	0CURVAXX21		100/150 direct coaxial wall term. (*)	0TERMTET01
	100/150 Tee fitting M/M/F cap	0RACTTAP00			





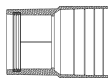

(*) Items normally not in stock, minimum stock availability time 8 weeks.



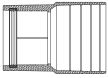
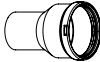

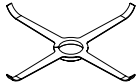

SPLIT FLUE FITTINGS FOR CONDENSING BOILERS Ø 50

Item	Description	Code	Item	Description	Code
	Adapter M/F Ø80/50	0RIDUZIO32		Condensate drain Ø50 (*)	0SCARCON05
	Extention M/F Ø50 L=1m (*)	0PROLUNG32		Vertical flue vent terminal Ø50 H=145cm (*)	0TERMTET02
	90° elbow Ø50 (*)	0CURVAXX33		Flexible pipe M/F Ø50 (20m roll) (*)	0TUBOFLE08
	45° elbow Ø50 (*)	0CURVAXX34		Kit of adapters for flexible hose Ø50 (*)	0KADAFLE02
	Air intake terminal Ø50 L=1m (*)	0TERMASP02		Centring element for flexible hose Ø50 (*)	0CENTFLE03
	Flue vent terminal Ø50 L=0,36m (*)	0TERMSCA04		Vertical terminal for flexible hose Ø50 with flue cover (C9 type installation) (*)	0TERMTET03
	Tee M/M/F Ø50 (*)	0KITRACT06		Adapter Ø60/50 M-F (C9 type installation) (*)	0RIDUZIO33

(*) Items normally not in stock, minimum stock availability time 8 weeks.



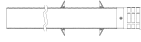
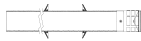















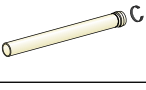

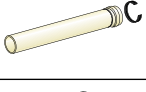

SPLIT FLUE FITTINGS FOR CONDENSING BOILERS Ø 60

Item	Description	Code
	Adapter Ø80/60	0RIDUZIO19
	Adapter M/F Ø 60-80 M/F	0RIDUZIO10
	Flexible pipe M/F Ø60 (20m roll)	0TUBOFLE07
	Kit of adapters for flexible hose Ø60	0KADAFLE01
	Centring element for flexible hose Ø60	0CENTFLE02
	90° elbow Ø60	0CURVAXX16
	45° elbow Ø60	0CURVAXX17
	Extension M/F Ø60 L=1m	0PROLUNG16

Item	Description	Code
	Extension M/F Ø60 L=2 m	0PROLUNG17
	Extension M/F Ø60 L=0.5 m	0PROLUNG18
	Tee M/M/F Ø60	0RACCORT06
	Condensate drain Ø60	0SCARCON03
	Air intake terminal Ø60 L=1m	0TERMASP01
	Flue vent terminal Ø60 L=1m	0TERMSCA01
	Vertical terminal for flexible hose Ø60 with flue cover (C9 type installation) (*)	0TERMTET04











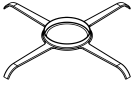

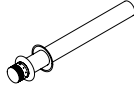

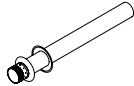

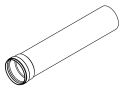

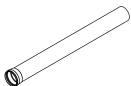
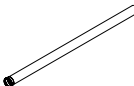



(*) Items normally not in stock, minimum stock availability time 8 weeks.

SPLIT FLUE FITTINGS FOR CONDENSING BOILERS Ø 80





Item	Description	Code	Item	Description	Code
	Splitter kit Ø80+80	0KITSDOP08		Suction opening in AISI316 Stainless steel Ø80 H=30mm (for TFS boilers)	0GRIASIN00
	Telescopic extension M/F Ø80 (0.34-0.45m)	0PROLTEL01		Flanged flue gas starter fitting D 80 (for boiler ITACA CH KR)	0PARTFUM01
	45° elbow M/F Ø80	0CURVAXX01		Air intake stub pipe + inspection (for boiler ITACA CH KR)	0TRONASP00
	Suction opening Ø80	0GRIGASP01		Split starting kit 80 (for boiler ITACA CH KR)	0KITSDOP06
	Flue vent chimney Ø80 H=138cm	0CAMISCA00		Extension M/F Ø80 L=1 m	0PROLUNG00
	Flue gas intake/vent chimney Ø80+80 H=138.4cm	0CAMIASP00		Extension M/F Ø80 L=0.5 m	0PROLUNG01
	Tee kit for visual inspection and collecting condensate Ø80	0KITRACT00		90° elbow M/F Ø80	0CURVAXX02
	Flexible pipe M/F Ø80 (20m roll)	0TUBOFLE06		Flue vent terminal Ø80 L=1m	0TERMSCA00
	Kit of adapters for flexible hose Ø80 (included gaskets)	0KADAFLE00		Vertical terminal for flexible hose Ø80 with flue cover (C9 type installation) (*)	0TERMTET05
	Centring element for flexible hose Ø80	0CENTFLE00		Double lip seal Ø80 for condensation	0GUADOLA04
	Tee M/M/F Ø80	0RACCORT00		Seal for flexible hose Ø80 (10pcs) (included in 0KADAFLE00)	0GUAFLEX00
	Wall rosette in silicone, ID Ø80 OD Ø170	0ROSPASIO0			





(*) Items normally not in stock, minimum stock availability time 8 weeks.

SPLIT FLUE FITTINGS FOR CONDENSING BOILERS Ø 100

Item	Description	Code	Item	Description	Code
	Centring element for flexible hose Ø100	0CENTFLE01		Roof terminal Ø100	0TERCOIN01
	90° elbow with inspection M/F Ø100	0CURVAXX08		Air intake terminal Ø100 L=1m	0TERMASP00
	90° elbow M/F Ø100	0CURVAXX10		Flue vent terminal Ø100 L=1m	0TERMSCA03
	45° elbow M/F Ø100	0CURVAXX11		Vertical stub pipe with inspection M/F Ø100 L=140mm	0TROSCAF01
	Extension M/F Ø100 L=0.5 m	0PROLUNG07		Flexible pipe M/F Ø100 (without seals, 20m roll)	0TUBOFLE04
	Extension M/F Ø100 L=1 m	0PROLUNG08		Extension M/F Ø100 L=2 m	0PROLUNG09
	Tee M/M/F Ø100	0RACCORT01		Flanged flue gas starter fitting D 100 (for boiler ITACA CH KR)	0PARTFUM00
	Tee kit M/M/F Ø100 for visual inspection and draining condensate	0RACCORT02		D100 Suction opening	0GRIGASP02
	Tee kit M/M/F Ø100 for visual inspection	0RACCORT03		Sealing collar kit D 100	0KCOLLBL00
	Adapter Ø80/100	0RIDUZIO13		Split starting kit 100 + 100 (for boiler ITACA CH KR)	0KITSDOP05
	Condensate drain kit Ø100	0SCARCON00		Air intake flanged stub pipe D 100 (for boiler ITACA CH KR)	0TRONFLA05
	Condensate drain trap with horizontal fitting	0SIFCOND00		Double lip seal Ø100 for condensation	0GUADOLA03
	Condensate drain trap with vertical fitting	0SIFCOND01			





FITTINGS FOR MODULES FLUE GAS COLLECTORS Ø 160





Item	Description	Code
	Flue gas pipe for thermal module Ø 160	0COLLFUM03
	Extension L 500 Ø160 (*)	0PROLUNG31
	Extension M/F Ø160 L=1 m (*)	0PROLUNG10
	90° elbow M/F Ø160 (*)	0CURVAXX12
	45° elbow M/F Ø160 (*)	0CURVAXX14

Item	Description	Code
	Tee M/M/F Ø160 (*)	0RACCORT04
	Plug kit for flue gas duct Ø160 (with the possibility to drain condensate)	0SCARCON01
	Elbow 30° M/F Ø160 (*)	0CURVAXX28
	Elbow 15° M/F Ø160 (*)	0CURVAXX30

(*) Items normally not in stock, minimum stock availability time 8 weeks.





FITTINGS FOR MODULES FLUE GAS COLLECTORS Ø 200



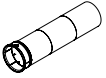

Item	Description	Code
	90° elbow M/F Ø200 (*)	0CURVAXX13
	45° elbow M/F Ø200 (*)	0CURVAXX15
	Extension M/F Ø200 L=1 m (*)	0PROLUNG13
	Extension M/F Ø200 L=0.475 (for connection of flue gas pipes, installation with no cabinet) (*)	0PROLUNG15
	Tee M/M/F Ø200 (*)	0RACCORT05

Item	Description	Code
	Plug kit for flue gas duct Ø200 (with the possibility to drain condensate)	0SCARCON02
	Flue gas pipe for thermal module Ø 200	0COLLFUM05
	Extension D 200 L 370 mm for the connection of two adjacent flue gas collectors D 200	0PROLUNG25
	Elbow 30° M/F Ø200 (*)	0CURVAXX27
	Elbow 15° M/F Ø200 (*)	0CURVAXX29

(*) Items normally not in stock, minimum stock availability time 8 weeks.

FITTINGS FOR MODULES FLUE GAS COLLECTORS Ø 250













Item	Description	Code
	Flue gas pipe for thermal module Ø 250	0COLLFUM06
	Extension Ø250 L 370 mm for the connection of two adjacent flue gas collectors Ø250	0PROLUNG26
	Extension Ø250 L 500 mm (*)	0PROLUNG29
	Extension Ø250 L 1000 mm (*)	0PROLUNG30
	Elbow Ø250 90° (*)	0CURVAXX26
	Elbow Ø250 45° (*)	0CURVAXX25

Item	Description	Code
	Elbow Ø250 30° (*)	0CURVAXX24
	Elbow Ø250 15° (*)	0CURVAXX23
	Tee fitting M/M/F Ø250 (*)	0RACCORD28
	Fitting for collector Ø250 with condensate drain	0SCARCON04
	Elbow Ø250 with inspection (*)	0CURVISPO6

(*) Items normally not in stock, minimum stock availability time 8 weeks.





ACCESSORIES

THERMOREGULATION AND ELECTRONIC

Item	Description	ANTEA KC	ANTEA KR	ANTEA KRB	ANTEA NEXT KC	ANTEA NEXT KR	ANTEA NEXT KRB	FORMENTERA KC	FORMENTERA KR	FORMENTERA KRB	GIAVA KRB	ITACA CH KR	ITACA KC	ITACA KR	ITACA KRB	ITACA KB	TENERIFE KC	ANTEA PRO CTN	FORMENTERA PRO CTN	Code
	Thermostat starter kit + Spot gateway	●	●	●	●	●	●	●	●	●	●		●	●	●	●	●	●	●	0SPOTAPP01
	Zone expansion for Spot thermostat	●	●	●	●	●	●	●	●	●	●		●	●	●	●	●	●	●	0EXPSPOT01
	Remote control, ErP V class (118x85x32 mm)	●	●	●	●	●	●	●	●	●	●	●	●	●	●	●	●	●	●	0CREMOTO04
	Antifreeze heating element kit	●	●	●	●	●	●	●	●	●			●	●	●	●	●	●	●	0KANTIGE00
	Ambient temperature probe				●	●	●				●		●	●	●	●	●			0KITSAMB00
	Surge arrester kit	●	●	●	●	●	●	●	●	●	●	●	●	●	●	●	●	●	●	0KITSCAR00
	Electric kit for complex solar plant management	●	●	●				●	●	●	●		●	●	●	●			●	0KITSOLC08
	hot water storage tank temperature probe 3m		●	●		●	●		●	●		●		●	●					0KITSOND00
	Electrical kit for zone management with external probe	●	●	●				●	●	●	●		●	●	●	●			●	0KITZONE05
	External probe											●								0KSONEST01
	External probe (60x45x31 mm)	●	●	●	●	●	●	●	●	●	●		●	●	●	●	●	●	●	0SONDAES01
	Electromechanical ambient thermostat, ErP I class (71x71x40 mm)	●	●	●	●	●	●	●	●	●	●	●	●	●	●	●	●	●	●	0TERAMEL00







ACCESSORIES

THERMOREGULATION AND ELECTRONIC

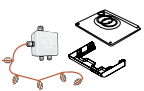
Item	Description	ANTEA KC	ANTEA KR	ANTEA KRB	ANTEA NEXT KC	ANTEA NEXT KR	ANTEA NEXT KRB	FORMENTERA KC	FORMENTERA KR	FORMENTERA KRB	GIAVA KRB	ITACA CH KR	ITACA KC	ITACA KR	ITACA KRB	ITACA KB	TENERIFE KC	ANTEA PRO CTN	FORMENTERA PRO CTN	Code
	Master slave connection kit 45-150kw											●								0KITCASC00
	Kit Modbus Itaca CH											●								0KMODBUS00
	NTC probe kit for 10k beta 3977 circuit breaker (*)				●	●	●													0KITSOND01
	PT 1000 probe kit with ring connection (*)				●	●	●													0KITSOPT00

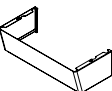
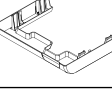
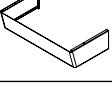
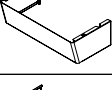
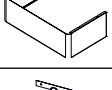



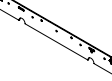





ACCESSORIES

OUTDOOR INSTALLATION PARTIALLY PROTECTED AND OPTIONAL ACCESSORIES

Item	Description	ANTEA KC	ANTEA KR	ANTEA KRB	ANTEA NEXT KC	ANTEA NEXT KR	ANTEA NEXT KRB	FORMENTERA KC	FORMENTERA KR	FORMENTERA KRB	ITACA KC	ITACA KR	ITACA KRB	ITACA KB	TENERIFE KC	ANTEA PRO CTN	FORMENTERA PRO CTN	Code
	Coaxial air intake/flue gas venting connection for B23 type installations							●	●	●	●	●	●					0ATTCOVE06
	Outdoor cover kit with antifreeze protection kit							●	●	●	●	●	●					0KITCOPE01
	Outdoor cover kit							●	●	●	●	●	●					0KITCOPE02
	Compact wall pipe cover - Height 110 mm - Width 400 mm - Depth (upper part) 194 mm - Depth (lower part) 165 mm	●	●	●											●	●		0COPETUB00
	Pipes and taps low plastic cover							●	●	●	●	●	●				●	0COPETUB03
	Pipes and taps cover													●				0COPETUB05
	Pipes and taps high metal cover							●	●	●	●	●	●				●	0COPETUB07
	Covering pipes and boiler taps Next (*)				●	●	●											0COPETUB08
	Basic compact install. metal template	●	●	●												●		0DIMMECO10
	Metal fixing template							●	●	●	●	●	●				●	0DIMMECO11
	Wall spacing kit	●	●	●				●	●	●	●	●	●		●	●	●	0DISTANZ00
	Wall mounting bracket for compact boiler	●	●	●												●		0KSTASOS00

ACCESSORIES

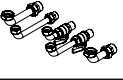
HYDRAULIC

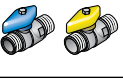
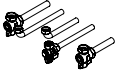
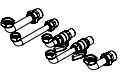
Item	Description	ANTEA KC	ANTEA KR	ANTEA KRB	ANTEA NEXT KC	ANTEA NEXT KR	ANTEA NEXT KRB	FORMENTERA KC	FORMENTERA KR	FORMENTERA KRB	GIAVA KRB	ITACA CH KR	ITACA KC	ITACA KR	ITACA KRB	ITACA KB	TENERIFE KC	ANTEA PRO CTN	FORMENTERA PRO CTN	Code
	Magnetic dirt separator filter	●	●	●	●	●	●	●	●	●	●		●	●	●	●	●	●	●	0AFILDEF00
	Condensate neutralizer kit (Pmax 350 kw)											●								0FILNECO01
	Condensate neutralizer kit (Pmax 85 kw)											●								0FILNECO03
	Flow - return cold water 90° taps kit																	●	●	0KITIDBA11
	Tap kit with filter KR-KB-RT		●			●			●					●		●				0KITRUBI04
	Tap kit with filter KC-KRB-CT-RBT	●		●	●		●	●		●			●		●		●	●	●	0KITRUBI05
	Giava recirculation optional kit										●									0KRICIRC00
	Filter refill Pmax 350kW - QTY 1 for Outputs up to 350 kW - QTY 2 for Outputs up to 700 kW - QTY 3 for Outputs up to 900 kW											●								0RICAFIL01
	Filter refill											●								0RICAFIL03
	Basic hydraulic kit																	●		0KITIDBA29
	Basic solar kit	●			●			●					●				●	●	●	0KITSOLC09
	Gas and water cock kit	●	●	●				●	●	●			●	●	●	●	●	●	●	0KITRUBI01
	Boiler hydraulic kit	●						●					●				●	●	●	0KITIDBA22
	Basic hydraulic kit Next boilers				●	●	●													0KITIDBA30



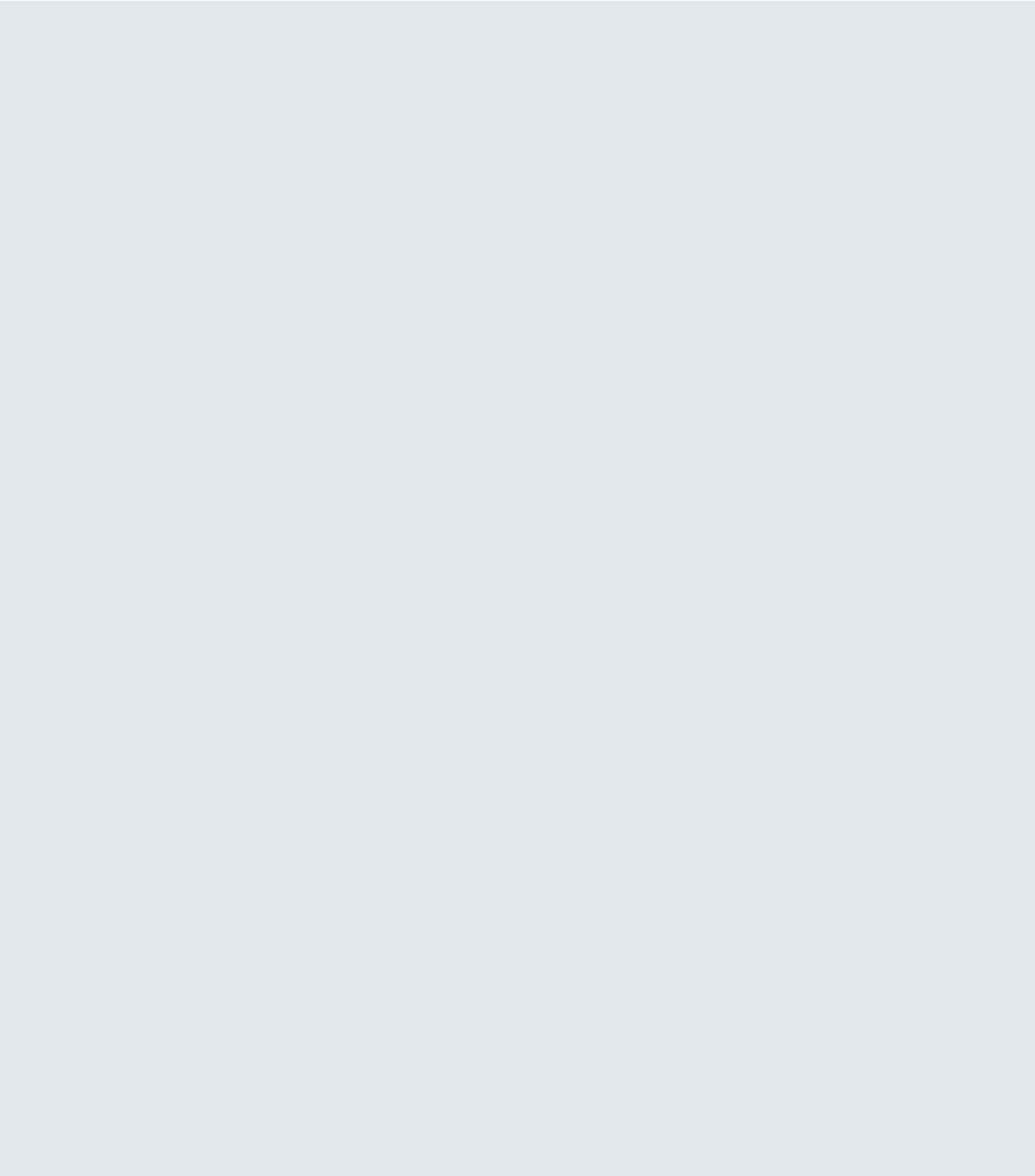



SOLAR THERMAL PRODUCTS

COLLECTORS

Solar collectors HWF 20 - HWF 26	page 118
----------------------------------	----------

SYSTEMS

Sulpack Evo	page 119
Sulpack Pro	page 120
Sulpack Easy	page 121
Sulpack Natural Plus	page 122

ACCESSORIES

Solar pump group rs1, only return	page 124
Solar pump group mrs3, flow and return	page 124
Circulation pumps	page 125
Additional tanks	page 125
Expansion vessels	page 125
Accessories for tanks	page 126
Thermostatic mixing valve	page 126
Three-way deviating valve	page 127
Concentrated solar protection liquid	page 127
Pipes for solar plants	page 128
Fitting for solar plants	page 128
Solar kit for combination boilers	page 129
Temperature probe	page 129
SG2 solar control unit	page 130
SG3 solar control unit	page 130



SOLAR COLLECTORS HWF 20 - HWF 26

SOLAR THERMAL FLAT-PLATE COLLECTORS FOR INSTALLATION ON FLAT ROOF AND PITCHED-ROOF (PARALLEL OR IN-ROOF INSTALLATION)

HWF 20 included in the GSE "Solar thermal catalogue"



- ▶ **High-efficiency aluminium absorber**
- ▶ **Copper piping**
- ▶ **Laser welding**
- ▶ **Aluminium tank-frame**
- ▶ **Rock wool insulation with a thickness of 40 mm**
-) Tempered clear glass with low iron content
-) Possibility to connect up to 8 collectors in series
-) Suitable for installation in the vertical direction, with the short side on top

Data	um	HWF 20	HWF 26
Total gross surface	m ²	2,06	2,62
Absorber surface	m ²	1,93	2,47
Absorbance	%	95	95
Emission	%	5	5
Glass transmittancy	%	91	91
Liquid content	litres	0,9	1,14
Maximum operating pressure	bar	10	10
Net weight	kg	32,2	39,3
Stagnation temperature	°C	201	201
Opening surface	m ²	1,93	2,47
η_0	-	0,75	0,75
α_1	W/(m ² K)	3,17	3,17
α_2	W/(m ² K ²)	0,012	0,012
IAM (K 50°)	-	0,95	0,95
External dimensions HC 25 (W x H x D)	mm	2022x1019x90	2022x1295x90
Code	-	PSHWF20000	PSHWF26000

Package includes: collectors.

Description	Code	Description	Code
Viton seals (10 pieces) (*)	PSGUAHWF00	HWF 20 single collector in-roof installation kit	PSKITCOP08
Collector connection kit	PSKITHWF00	HWF 20 supplementary collector in-roof installation kit	PSKITCOP09
Joining kit for two collectors	PSKITHWF01	HWF 20 single collector in-roof installation kit	PSKITCOP10
HWF 20 single collector fixing kit, for installation on the roof	PSKMHWF206	HWF 20 supplementary collector in-roof installation kit	PSKITCOP11
HWF 20 single collector fixing kit, brackets for roofs with wood-blocks	PSKMHWF207	HWF 26 single collector fixing kit, for installation on the roof	PSKMVL2506
HWF 20 single collector fixing kit, brackets for roofs without wood-blocks	PSKMHWF208	HWF 26 single collector fixing kit, brackets for roofs with wood-blocks	PSKMVL2507
HWF 20 single collector fixing kit, installation on roof with an inclination of 35°	PSKMHWF209	HWF 26 single collector fixing kit, brackets for roofs without wood-blocks	PSKMVL2508
Single collector fixing kit HWF 20, for sheet metal roofing	PSKMHWF210	HWF 26 single collector fixing kit, installation on roof with an inclination of 35°	PSKMVL2509
Single collector fixing kit HWF 26, for sheet metal roofing	PSKMVL2510		

(*) Product available while stocks last

SULPACK EVO

SOLAR KIT FOR FORCED CIRCUIT WITH HEAT INTEGRATION IN THE HOT WATER STORAGE TANK



- › **Solar collectors**
- › **High thermal insulation glazed hot water storage tank**
- › **Two-way hydraulic unit with high efficiency solar pump, factory assembled**
- › **Hydraulic and safety accessories**
 -) ES solar expansion vessel
 -) Hose with bracket for tanks
 -) Thermostatic mixing valve
 -) Propylene glycol for solar plants
 -) Sealing gaskets

The solar kit can be combined with wall-hung pre-mixed condensing boilers for sole heating. This solar kit requires you to position the hot water storage tank inside the building, preferably close to the heat power plant. By means of appropriate temperature probes which regulate its operation, a pump enables circulation of the liquid in the solar circuit.

Technical data	um	HWF 20 - 200	PLUS HWF 20 - 200	HWF 20 - 300	HWF 26 - 200	HWF 26 - 300
Orientation	-	Vertical				
Collectors	num.	1	2	2	1	2
Model	-	HWF 20			HWF 26	
hot water storage tank	-	WHPS BZ 200 DS	WHPS BZ 200 DS	WHPS BZ 300 DS	WHPS BZ 200 DS	WHPS BZ 300 DS
hot water storage tank energy efficiency class	-	B →	B →	B →	B →	B →
Usable tank volume [Vu]	l	196	196	273	196	273
Tank dispersion [S]	W	51	51	63	51	63
Back up vol. [Vbu]	l	67	67	85	67	85
Solar unit	-	2 ways				
Qnonsol (M)	kWh	855	632	681	749	673
Qnonsol (L)	kWh	1851	1231	1245	1640	1058
Qnonsol (XL)	kWh	3331	2445	2431	3055	2079
Qnonsol (XXL)	kWh	4472	3469	3443	4169	3011
Solar pump consumption [solpump]	W	45				
Qaux	W	91				
Standby consumption [solsb]	W	0,08				
Expansion vessel	-	ES 18				
Propylene glycol to be mixed	kg	10				
Code	-	PSPACKEV05	PSPACKEV07	PSPACKEV06	PSPACKEV08	PSPACKEV09

The solar kits do not include the retainers for roof installation, to be chosen among those specified for the different types of collectors, connection pipes and temperature probes. The solar control unit, if necessary, must be chosen among those indicated in the solar accessories in case you do not use a Fondital boiler set to manage the solar system.

SULPACK PRO

SOLAR KIT FOR FORCED CIRCUIT WITH HEAT INTEGRATION IN THE HOT WATER STORAGE TANK



- › **Solar collectors**
- › **Glazed hot water storage tank**
- › **Two-way hydraulic unit with high-efficiency solar pump**
- › **Hydraulic and safety accessories**

-) ES solar expansion vessel
-) RS additional solar tank
-) Hose with bracket for tanks
-) Thermostatic mixing valve
-) Propylene glycol for solar plants
-) Sealing gaskets

The solar kit can be combined with wall-hung pre-mixed condensing boilers for sole heating. This solar kit requires you to position the hot water storage tank inside the building, preferably close to the heat power plant. By means of appropriate temperature probes which regulate its operation, a pump enables circulation of the liquid in the solar circuit.

Technical data	um	HWF 20 - 200	HWF 20 - 300	HWF 20 - 500	HWF 26 - 200	HWF 26 - 300	HWF 26 - 500
Orientation	-	Vertical					
Collectors	num.	1	2	3	1	2	3
Model	-	HWF 20			HWF 26		
hot water storage tank	-	WHPS BNF 200 DS	WHPS BNF 300 DS	WHPS BNF 500 DS	WHPS BNF 200 DS	WHPS BNF 300 DS	WHPS BNF 500 DS
hot water storage tank energy efficiency class	-						
Usable tank volume [Vu]	l	196	273	475	196	273	475
Tank dispersion [S]	W	67	85	112	67	85	112
Back up vol. [Vbu]	l	67	85	130	67	85	130
Solar unit	-	2 ways					
Qnonsol (M)	kWh	940	827	972	844	820	974
Qnonsol (L)	kWh	1916	1370	1188	1714	1193	1150
Qnonsol (XL)	kWh	3383	2531	1990	3114	2192	1691
Qnonsol (XXL)	kWh	4518	3531	2804	4220	3111	2374
Solar pump consumption [solpump]	W	45					
Qaux	W	91					
Standby consumption [solsb]	W	0,08					
Expansion vessel	-	ES 12	ES 18	ES 25	ES12	ES 18	ES 25
Additional tank	-	RS 5	RS 5	RS 8	RS5	RS5	RS 8
Propylene glycol to be mixed	kg	10					
Code	-	PSPACKEX06	PSPACKEX07	PSPACKEX08	PSPACKEX09	PSPACKEX10	PSPACKEX11

The solar kits do not include the retainers for roof installation, to be chosen among those specified for the different types of collectors, connection pipes and temperature probes. The solar control unit, if necessary, must be chosen among those indicated in the solar accessories in case you do not use a Fondital boiler set to manage the solar system.

SULPACK EASY

SOLAR KIT FOR FORCED CIRCUIT WITHOUT HEAT INTEGRATION IN THE HOT WATER STORAGE TANK



- › **Solar collectors**
- › **Glazed hot water storage tank**
- › **One-way hydraulic unit with high efficiency solar pump**
- › **Hydraulic and safety accessories**

-) Sealing gaskets
-) ES solar expansion vessel
-) Hoses with brackets for tanks
-) Thermostatic mixing valve
-) Propylene glycol for solar plants

The solar kit can be combined to wall-hung combination boilers with instantaneous production of domestic hot water, using the solar kit for instantaneous boilers. The solar kit do not include the retainers for roof installation, to be chosen among the systems specified for the different types of collectors and connection pipes.

Technical data	-	HWF 20 - 200	HWF 20 - 300	HWF 20 - 500	HWF 26 - 200	HWF 26 - 300	HWF 26 - 500
Orientation	-	Vertical					
Collectors	num.	1	2	3	1	2	3
Model	-	HWF 20			HWF 26		
hot water storage tank	-	WHPS BNF 200 SS	WHPS BNF 300 SS	WHPS BNF 500 SS	WHPS BNF 200 SS	WHPS BNF 300 SS	WHPS BNF 500 SS
hot water storage tank energy efficiency class	-	C	C	C	C	C	C
Usable tank volume [Vu]	l	196	273	475	196	273	475
Tank dispersion [S]	W	67	85	112	67	85	112
Solar unit	-	1 way					
Qnonsol (M)	kWh	849	778	930	772	774	932
Qnonsol (L)	kWh	1775	1277	1132	1591	1119	1099
Qnonsol (XL)	kWh	3212	2391	1884	2956	2072	1607
Qnonsol (XXL)	kWh	4335	3368	2668	4048	2966	2261
Solar pump consumption [solpump]	W	45					
Qaux	W	91					
Standby consumption [solsb]	W	0,08					
Expansion vessel	-	ES 12	ES 18	ES 25	ES 12	ES 18	ES 25
Propylene glycol to be mixed	kg	10					
Code	-	PSPACKEY06	PSPACKEY07	PSPACKEY08	PSPACKEY19	PSPACKEY20	PSPACKEY21

The solar kits do not include the retainers for roof installation, to be chosen among the systems specified for the different types of collectors, connection pipes and temperature probes. The solar control unit, if necessary, must be chosen among those indicated in the solar accessories in case you do not use a Fondital boiler set to manage the solar system (for combination boilers only).



The Solar Kit for instant boilers allows you to bypass the boiler if water temperature from the solar tank is higher than 48 °C. It includes one unit integrating both a thermostatic deviating valve and an adjustable thermostatic mixing valve.

If you order the solar kit for boiler, when ordering a SULPACK EASY KIT, the mixing valve will not be supplied and will automatically be eliminated from the cost of the kit.

For solar kits for combination boilers, refer to page 129

SULPACK NATURAL PLUS

SULPACK NATURAL PLUS



- › Solar collectors
- › Glazed hot water storage tank
- › Fastening system for tilted roof
- › Hydraulic connection accessories
- › 1500W auxiliary electric resistance supplied as standard, adjustable by means of a thermostat
-) Heat transfer fluid circuit safety valve
-) Double magnesium anode
-) Domestic cold water input check and safety valve

The Sulpack Natural Plus system can be combined to Fondital combination boilers with instantaneous production of domestic hot water, using the solar kit for instantaneous boilers. The Solar Kit allows you to bypass the boiler if water temperature from the solar tank is higher than 48 °C.

Technical data	um	150	200	300
Collectors	num.	1	1	2
Gross surface (single collector)	m ²	2,11		
Liquid content (single collector)	litres	1,4		
Collector structure material	-	aluminium		
Glass	type	low-iron		
Thickness	mm	3,2		
Insulation	type	mineral wool		
Insulation thickness	mm	40		
Size (W x L x H) (single collector)	mm	1036x2037x90		
Overall empty weight (single collector)	kg	42		
Opening surface (single collector)	m ²	1,92		
η ₀	-	0,702		
α ₁	W/(m ² K)	3,930		
α ₂	W/(m ² K ²)	0,007		
IAM	-	0,91		
Absorber				
Surface (single collector)	m ²	1,91		
Material	type	aluminium		
Finishing	type	selective		
Tank				
hot water storage tank energy efficiency class	-	C	C	C
Dissipation S	W	68	72	97
Hot water storage	litres	152	198	282
Heat exchanger	-	jacket	jacket	jacket
Heat transfer fluid capacity	litres	8,5	12	18,8
Insulation thickness	mm	50	50	50
Maximum operating pressure	bar	6	6	6
Internal finishing	type	enamelling	enamelling	enamelling
Corrosion protection	type	Anodic (double anode - Mg)		
Empty weight	kg	72	88	110
Electric resistance (as standard)	W	1500	1500	1500
Connections	-	G 3/4	G 3/4	G 3/4
Total amount of heat transfer fluid in the system	litres	11	14,5	22,5
Code	-	PSPACTER09	PSPACTER10	PSPACTER11

Description	Code
Supplementary kit for flat roofs, mod. 150	PSKITPAC03
Supplementary kit for flat roofs, mod. 200	PSKITPAC04

Description	Code
Supplementary kit for flat roofs, mod. 300	PSKITPAC05
Sulpack natural plus pressure-temperature safety valve	PSVALSIC00

It can be combined with the following models: ITACA KC - FORMENTERA KC - ANTEA KC - ANTEA PRO CTN - FORMENTERA PRO CTN

EXAMPLES

Connection to a boiler with integrated deviating valve Sulpack Pro / Sulpack Evo

① THERMOSTATIC MIXING VALVE

② TEMPERATURE PROBES

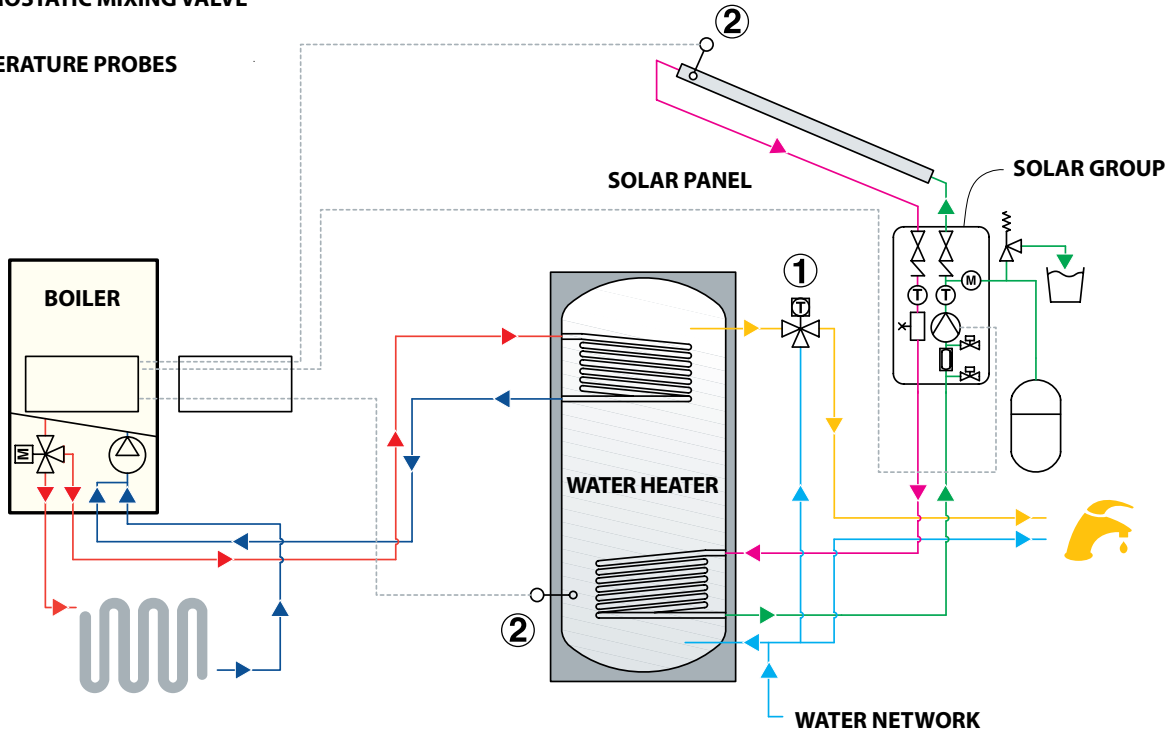

Connection to combination instantaneous boiler Sulpack Easy

① THERMOSTATIC DIVERTER VALVE

② THERMOSTATIC MIXING VALVE

③ TEMPERATURE PROBES

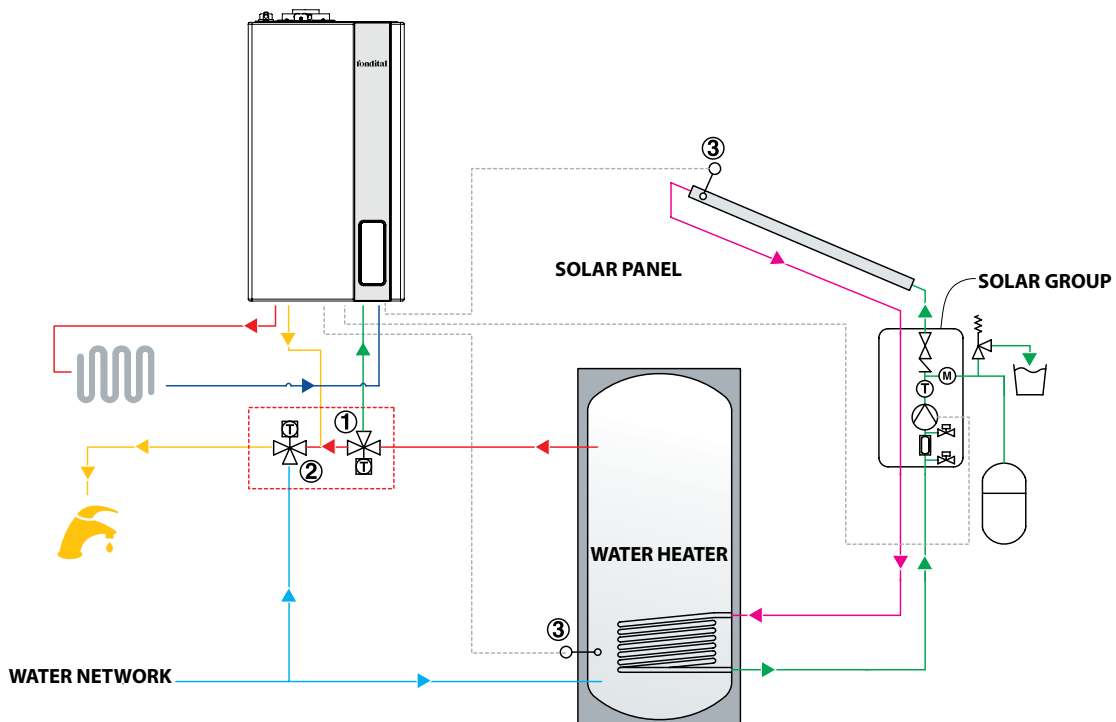

ACCESSORIES

SOLAR PUMP GROUP RS1, ONLY RETURN



Flow regulator with 0.5 to 15 l/min flow meter with integrated loading system

-) Ball tap with built-in return thermometer and check valve
-) Insulation in black EPP
-) High efficiency solar circulation pump
-) Solar safety valve calibrated at 6 bar
-) Pressure gauge with 10 bar scale
-) Expansion tank connection G 3/4
-) Wall-mounted, steel bracket included

SOLAR UNIT RS1

Flow rate adjustment	l/min.	0,5 ÷ 15
Max. head	m	7,5
Max. power	w	45
Code	PSGRUP0014	

SOLAR PUMP GROUP MRS3, FLOW AND RETURN



Flow regulator with 0.5 to 15 l/min flow meter with integrated loading system

-) Built-in degasser with manual bleed valve
-) Ball taps with built-in flow and return thermometers and check valve
-) Insulation in black EPP
-) High efficiency solar circulation pump
-) Solar safety valve calibrated at 6 bar
-) Pressure gauge with 10 bar scale
-) Expansion tank connection G 3/4
-) Wall-mounted, steel bracket included

SOLAR UNIT MRS3

Flow rate adjustment	l/min.	0,5 ÷ 15
Max. head	m	7,5
Max. power	w	45
Code	PSGRUP0015	

CIRCULATION PUMPS

High-efficiency circulation pumps for solar plants



SOLAR CIRCULATION PUMP C6		
Maximum head	m	5,4
Max. power	w	49
Fan	num.	3
Fittings	-	41
Maximum ambient temperature	°C	60
Maximum temperature of solar fluid	°C	110
Code	PSCIRCOLA7	

ADDITIONAL TANKS

Diaphragm-free tank with tank protection feature
Colour White



ADDITIONAL TANKS		RS 5	RS 8	RS 12
Capacity	litres	5	8	12
Diameter	mm	160	200	270
Height	mm	270	280	264
Fitting	-	2 x G ¾ M		
Max. pressure	bar	10		
Code		PSVASO0009	PSVASO0010	PSVASO0011

EXPANSION VESSELS





Diaphragm for solar fluid for T max 100 °C.
Colour White



EXPANSION VESSELS		ES 12	ES 18	ES 25	ES 35	ES 50	ES 80	ES 100	ES 200	
Capacity	litres	12	18	25	35	50	80	105	200	
Diameter	mm	270	270	300	380	380	450	500	600	
Height	mm	264	350	392	377	525	608	665	812	
Fitting	-	G ¾					G 1			
Max. pressure	bar	10								
Preload	bar	2,5								
Code		PSVASO0001	PSVASO0002	PSVASO0003	PSVASO0004	PSVASO0005	PSVASO0006	PSVASO0007	PSVASO0008	

ACCESSORIES FOR TANKS



Item	Description	Code
	STES 5 - 25: Universal mounting bracket for expansion vessels and additional tanks up to a capacity of 25 litres.	PSVASO0012
	STES 5 - 18: Wall mounting bracket with clamp for additional tanks and expansion vessels up to a capacity of 18 litres	PSVASO0014
	STES 35 - 50: Quick wall-mounting bracket for expansion vessels up to a capacity between 35 and 50 litres.	PSVASO0015
	FLEX 600: Hose for solar tanks, 600 mm long.	PSVASO0016
	STES 12 - 50 w/valve: Wall mounting bracket with double shut-off fitting for expansion vessels up to a capacity of 50 litres. Allows tank control without emptying the system.	PSVASO0017

THERMOSTATIC MIXING VALVE



-) Bronze external body
-) Internal parts in special anti-scale plastic
-) Automatic shut-off if no mixing cold water is available

THERMOSTATIC MIXING VALVE		
Fittings	-	G 1 M
Temperature range	°C	35 - 50
Maximum operating temperature	°C	100
Maximum flow rate	l/h	1500
Code	PSVALMIX00	

THERMOSTATIC MIXING VALVE



-) Brass external body
-) Automatic shut-off if no mixing cold water is available

THERMOSTATIC MIXING VALVE		
Fittings	-	G 3/4 M
Temperature range	°C	30 - 60
Maximum operating temperature	°C	85
Maximum flow rate	l/h	1000
Code	PSVALMIX01	

THREE-WAY DEVIATING VALVE

Three-way deviating valve for solar plants with 3-wire auxiliary contact



THREE-WAY DEVIATING VALVE		
Fittings	-	G 3/4 M
Maximum operating temperature	°C	160
Code	PSVALDEV01	

CONCENTRATED SOLAR PROTECTION LIQUID

Concentrated monopropylene glycol-based antifreeze fluid, to be diluted in water



CONCENTRATED SOLAR PROTECTION LIQUID					
Quantity	kg	10	10	10	10
Percentage of protection liquid in the system	%	20	25	30	45
Minimum temperature	°C	-8	-12	-15	-28
Code	PSPROSOL04				

PIPES FOR SOLAR PLANTS



Splittable double flexible pipe system in AISI 316 L stainless steel with insulation coating in EPDM closed cell foam

-) External protection case in black polyethylene
-) Silicone cable for two-wire collector probe (maximum operating temperature in continuous duty: 280°C)
-) Maximum resistance to temperature values of 175°C for short periods
-) It includes 4 swivel nut connectors, 4 seals, 4 O-rings
-) Hose flaring is made using a steel washer and a brass nipple, which are included in the kit

		Stainless steel Tuboflex 12/20 (*)	Stainless steel Tuboflex 12/25 (*)	Stainless steel Tuboflex 16/20 (*)	Stainless steel Tuboflex 16/25 (*)
Diameter	mm	12	12	146	16
Length	m	20	25	20	25
Insulation thickness	mm	13			
Maximum working temperature in continuous duty	°C	125			
Code		PSTUBI0015	PSTUBI0016	PSTUBI0017	PSTUBI0018

(*) Product available while stocks last

FITTING FOR SOLAR PLANTS



-) The FITTING KIT includes 4 swivel nut connectors, 4 seals, 4 O-rings.
-) Hose flaring is made using a steel washer and a brass nipple, which are included in the kit
-) The NIPPLE KIT includes brass nipples in 3-piece package

FITTINGS FOR SOLAR PLANTS	Fitting kit for Tuboflex SS 12 (*)	Fitting kit for Tuboflex SS 16 (*)	Nipple kit G ½ for Tuboflex SS 12 (*)	Nipple kit G ¾ for Tuboflex SS 16 (*)
Code	PSTUBI0019	PSTUBI0020	PSTUBI0021	PSTUBI0022

(*) Product available while stocks last

SOLAR KIT FOR COMBINATION BOILERS



0KITSOLC07

Solar kit for combination instantaneous boilers; it can be combined with the boilers listed below for connection to the solar plants featuring forced circuit and natural circulation, with heat not integrated in the water heater SULPACK EASY and SULPACK NATURAL. The kit allows you to bypass the boiler if water temperature from the solar tank is higher than 48 °C and to adjust the maximum temperature of water delivered at the users/use points. Mixer valve adjustment interval: 30 - 56°C. Limit temperature for flow stop in case of lack of cold water: 60°C. Minimum working pressure: 0.5 bar. Optimum working pressure: 1 - 10 bar.

Consisting of:

-) One thermostatic deviating valve and one mixing valve
-) Connection pipes
-) Shut-off cocks:

ITACA KC FORMENTERA KC ANTEA KC FORMENTERA PRO CTN ANTEA PRO CTN		
System connection		Rear connections
Code		0KITSOLC07

TEMPERATURE PROBE

PT 1000 temperature probe for solar plants, suitable for all models of solar control unit

Heat paste supplied



SOLAR PROBE		
Bulb diameter	mm	6
Cable length	mm	2,5
Code		PSPTMILL00



SG2 SOLAR CONTROL UNIT



Control unit for managing 9 types of solar circuits.

-) Load of a twin-coil hot water storage tank with heat being integrated from the boiler
-) Management of a combined hot water storage tank
-) Possibility to have two arrays of collectors
-) Pre-set for thermal discharge
-) Five probe inputs
-) Two relay outputs
-) Two adjustable temperature differentials
-) Hysteresis settings
-) One pulse input for heat metering
-) Pump anti-seize function
-) Possibility to control circulation pumps in PWM or 0-10V
-) Wide LCD display showing system layout and probe current temperatures
-) Charts showing the trend of the probe temperature reading in time
-) Can be set for 10 types of systems

SG3 SOLAR CONTROL UNIT



Control unit for managing 12 types of solar circuits.

-) Load of a twin-coil hot water storage tank with heat being integrated from the boiler
-) Management of two hot water storage tanks in cascade-type connection
-) Management of a combined hot water storage tank
-) Possibility to have two arrays of collectors
-) Pre-set for thermal discharge
-) Five probe inputs
-) Two relay outputs
-) One output for modulating solar pump
-) Two adjustable temperature differentials
-) Hysteresis settings
-) One pulse input for heat metering
-) Pump anti-seize function
-) Collector protection function
-) Function for hot water storage tank thermal discharge during the night with collector
-) Heating pump post-circulation function
-) Wide LCD display showing system layout and probe current temperatures
-) Charts showing the trend of the probe temperature reading in time
-) Can be set for 13 types of systems

SOLAR ELECTRONIC CONTROL UNITS	SG2	SG3
Code	PSCENSO004	PSCENSO005 (while stocks last)

The supply includes collector probe and hot water storage tank probe (both PT 1000) as well as the wall-mounting base.



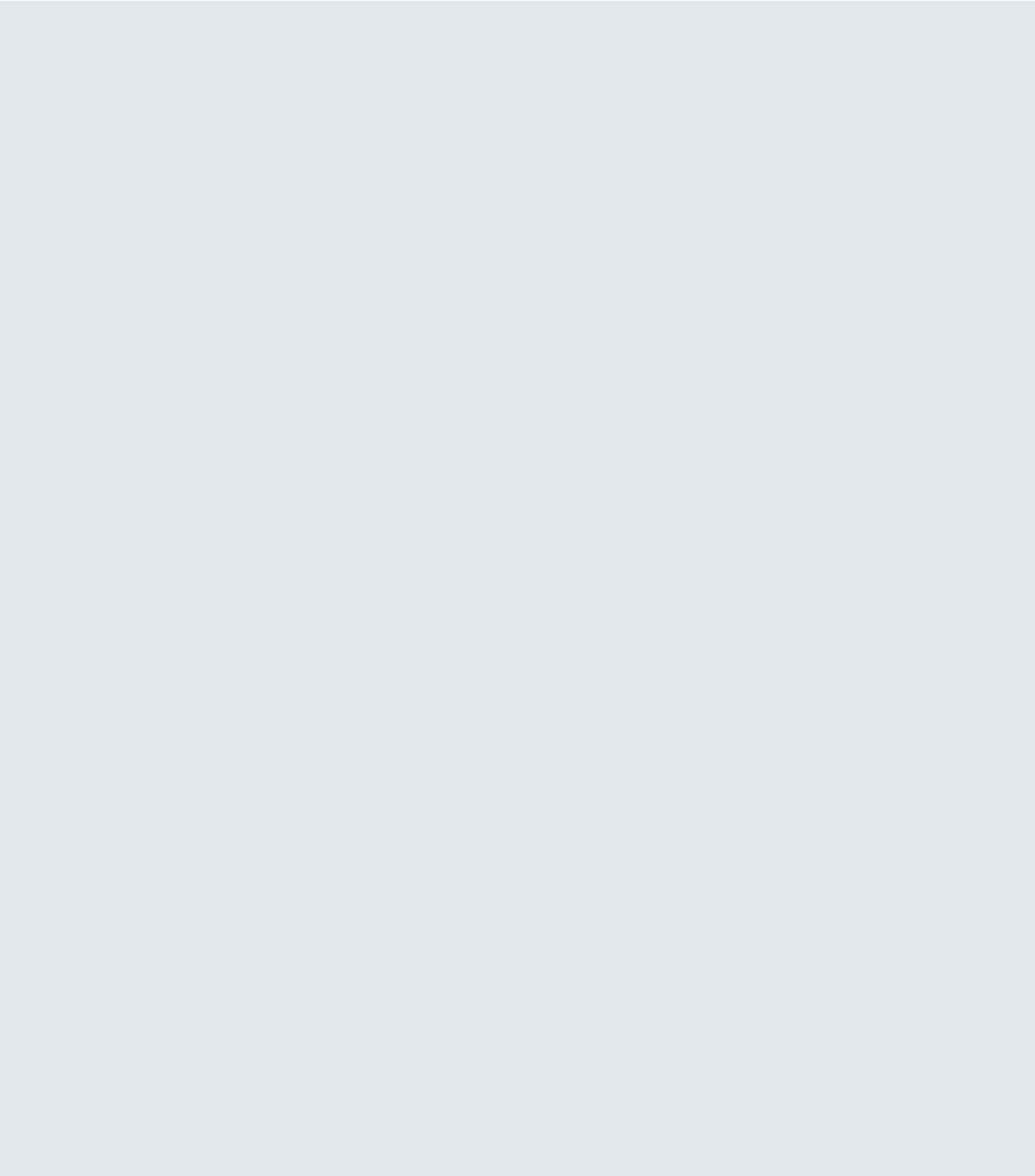



HOT WATER STORAGE TANKS

HOT WATER STORAGE TANKS

WHPS BNF SS 200 - 500	page 134
WHPS BNF DS 200 - 500	page 135
WHPS BNF SS E 200 - 500	page 136
WHPS BNF DS E 200 - 500	page 138
WHPS BA SS	page 140
WHPS BZ DS	page 141
WHPS PU S	page 142
WHPS BA DS	page 143



WHPS BNF SS

SOLAR HOT WATER STORAGE TANK WITH SINGLE COIL



- › **High efficiency and low operating costs**
- › **Can be integrated with solar systems**
- › **Fast storage with supply of abundant and continuous water**
-) Insulation in stiff expanded polyurethane, CFC and HCFC free
-) External case in white skai
-) Magnesium protection anode
-) DHW thermometer
-) DHW recirculation
-) Presetting for auxiliary resistor (thread G 1 1/2)



Available in the following capacities (l):

from 200 to 500

WHPS BNF SS is a hot water storage tank that can be combined with boilers for CH only, to produce domestic hot water, in porcelain-glass steel with single coil.

Model	Code	Dissipation S	Hot water storage	Energy efficiency class	Overall height	Outer diameter	Gross weight
		W	litres		mm	mm	
BNF 200 SS	PSBOLLV061	67	196	C	1215	600	90
BNF 300 SS	PSBOLLV062	85	273	C	1615	600	115
BNF 500 SS	PSBOLLV063	112	475	C	1705	750	155

Model		BNF 200 SS	BNF 300 SS	BNF 500 SS
Nominal volume	litres	200	300	500
Maximum working pressure	bar	10		
Maximum working temperature	°C	95		
Coil area	m ²	0,7	1,2	1,8
Coil power (ΔT 35 K)	kW	19	29	43
Tilting height	mm	1340	1735	1820
Insulation thickness	mm	50	50	50

Item	Description	Code
	Single electrode electronic anode - 200/300/500/1000	0ANOELET01
	Thermostat and thermometer kit	0KTERMTE00

Item	Description	Code
	3 kW heating element kit 390 mm-long heating element	DKRESELE02

WHPS BNF DS

SOLAR HOT WATER STORAGE TANK WITH DOUBLE COIL



- ▶ **Easy installation**
- ▶ **High efficiency and low operating costs**
- ▶ **Can be integrated with solar systems**
- ▶ **Fast storage with supply of abundant and continuous water**
-) Insulation in stiff expanded polyurethane, CFC and HCFC free
-) External case in white skai
-) Magnesium protection anode
-) DHW thermometer
-) DHW recirculation
-) Presetting for auxiliary resistor (thread G 1 1/2)



Available in the following capacities (l):

from 200 to 500

WHPS BNF DS is a hot water storage tank that can be combined with boilers for CH only, to produce domestic hot water, in porcelain-glass steel with double coil.

Model	Code	Dissipation S	Hot water storage	Backup volume	Energy efficiency class	Overall height	Outer diameter	Gross weight
		W	litres	Vbu		mm	mm	
BNF 200 DS	PSBOLLV064	67	196	67	C	1215	600	95
BNF 300 DS	PSBOLLV065	85	273	85	C	1615	600	130
BNF 500 DS	PSBOLLV066	112	475	130	C	1705	750	170

Model		BNF 200 DS	BNF 300 DS	BNF 500 DS
Nominal volume	litres	200	300	500
Maximum working pressure	bar	10		
Maximum working temperature	°C	95		
Auxiliary coil area	m ²	0,5	0,8	0,9
Solar coil area	m ²	0,7	1,2	1,8
Coil power (ΔT 35 K)	kW	12	19	23
Solar coil power (ΔT 35 K)	kW	19	29	43
Tilting height	mm	1340	1735	1820
Insulation thickness	mm	50	50	50

Item	Description	Code
	Single electrode electronic anode - 200/300/500/1000	0ANOELET01
	Thermostat and thermometer kit	0KTERMTE00

Item	Description	Code
	3 kW heating element kit 390 mm-long heating element	DKRESELE02

WHPS BNF SS E

GLASS-PORCELAIN STEEL SINGLE-COIL BOILER COMBINABLE WITH HEATING-ONLY BOILERS FOR DOMESTIC HOT WATER PRODUCTION



- › High efficiency and low operating costs
- › Can be integrated with solar systems
- › Fast storage with supply of abundant and continuous water
- › Thermometer and holders for probe included in the supply
- › Magnesium protection anode
- › DHW recirculation
- › Electric auxiliary heating element set-up
-) Insulation in stiff expanded polyurethane, CFC and HCFC free
-) Glass-porcelain interior
-) Grey stiff polystyrene external case



Available in the following capacities (l):

from 200 to 500

Model	Code	Dissipation S	Hot water storage	Energy efficiency class	Overall height	Outer diameter	Gross weight
		W	litres		mm	mm	
WHPS BNF 200 SS E	PSBOLLV071	57	189	B	1170	600	54
WHPS BNF 300 SS E	PSBOLLV072	67	273	B	1659	650	77
WHPS BNF 500 SS E	PSBOLLV073	108	484	C	1710	750	112

Model		BNF 200 SS E	BNF 300 SS E	BNF 500 SS E
Nominal volume	litres	200	300	500
Maximum working pressure	bar	10		
Maximum working temperature	°C	95		
Coil area	m ²	0,7	1,05	1,45
Coil power (ΔT 35 K)	kW	See graphs		
Tilting height	mm	1320	1790	1870
Insulation thickness	mm	50	75	50

Item	Description	Code	Item	Description	Code
	Single electrode electronic anode - 200/300/500/1000	0ANOELET01		3 kW heating element kit 390 mm-long heating element	DKRESELE02
	Thermostat and thermometer kit	OKTERMTE00			

Potenza scambiata / Exch. power

$T_{in,coil} = 80\text{ }^{\circ}\text{C}$; $T_{serb,in} = 10\text{ }^{\circ}\text{C}$, $T_{serb,out} = 45\text{ }^{\circ}\text{C}$

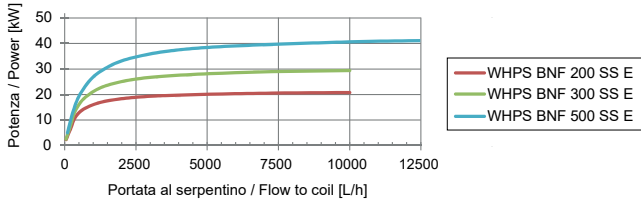

Potenza scambiata / Exch. power

$T_{in,coil} = 70\text{ }^{\circ}\text{C}$; $T_{serb,in} = 10\text{ }^{\circ}\text{C}$, $T_{serb,out} = 45\text{ }^{\circ}\text{C}$

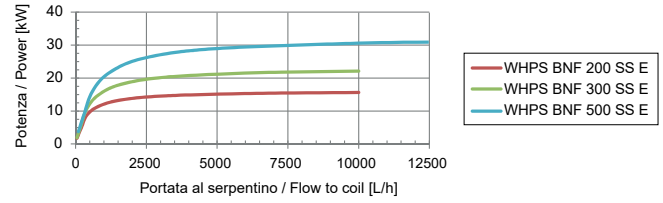

Potenza scambiata / Exch. power

$T_{in,coil} = 60\text{ }^{\circ}\text{C}$; $T_{serb,in} = 10\text{ }^{\circ}\text{C}$, $T_{serb,out} = 45\text{ }^{\circ}\text{C}$

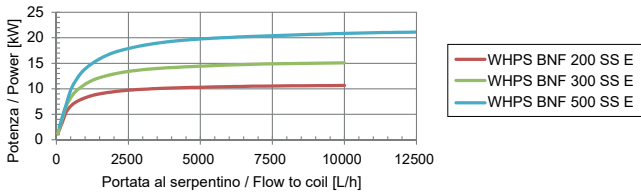

Potenza scambiata / Exch. power

$T_{in,coil} = 50\text{ }^{\circ}\text{C}$; $T_{serb,in} = 10\text{ }^{\circ}\text{C}$, $T_{serb,out} = 45\text{ }^{\circ}\text{C}$

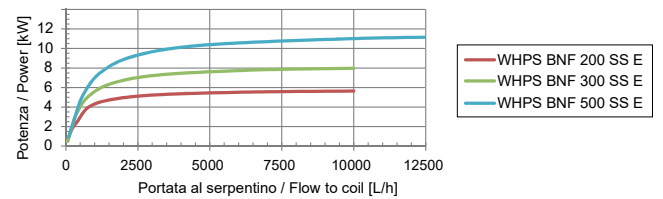

Perdite di carico sul serpentino / Coil pressure drop

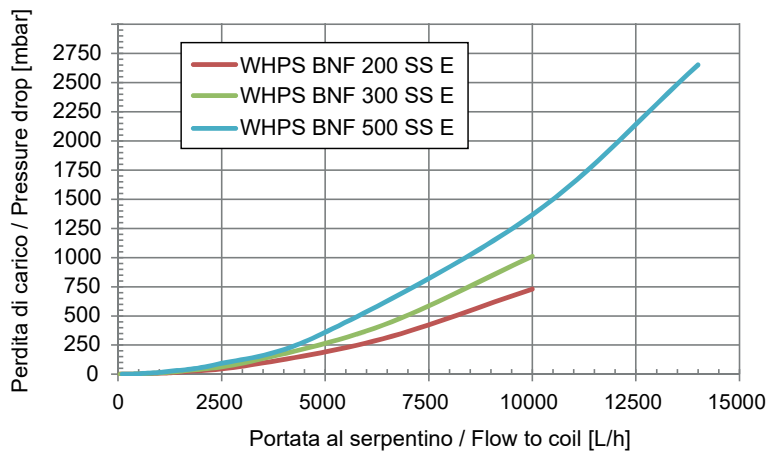

WHPS BNF DS E

GLASS-PORCELAIN STEEL DOUBLE-COIL BOILER COMBINABLE WITH HEATING-ONLY BOILERS FOR DOMESTIC HOT WATER PRODUCTION



- ▶ **High efficiency and low operating costs**
- ▶ **Can be integrated with solar systems**
- ▶ **Fast storage with supply of abundant and continuous water**
- ▶ **Thermometer and holders for probe included in the supply**
- ▶ **Magnesium protection anode**
- ▶ **DHW recirculation**
- ▶ **Electric auxiliary heating element set-up**
-) Insulation in stiff expanded polyurethane, CFC and HCFC free
-) Glass-porcelain interior
-) Grey stiff polystyrene external case
-) Easy installation



Available in the following capacities (l):

from 200 to 500

Model	Code	Dissipation S	Hot water storage	Backup volume	Energy efficiency class	Overall height	Outer diameter	Gross weight
		W	litres	Vbu		mm	mm	kg
WHPS BNF 200 DS E	PSBOLLV074	57	184	96	B	1170	600	63
WHPS BNF 300 DS E	PSBOLLV075	67	267	118	B	1659	650	94
WHPS BNF 500 DS E	PSBOLLV076	108	474	211	C	1710	750	141

Model		BNF 200 DS E	BNF 300 DS E	BNF 500 DS E
Nominal volume	litres	200	300	500
Maximum working pressure	bar	10		
Maximum working temperature	°C	95		
Auxiliary coil area	m ²	0,6	0,75	0,9
Solar coil area	m ²	0,8	1,2	1,8
Coil power (ΔT 35 K)	kW	See graphs		
Solar coil power (ΔT 35 K)	kW			
Tilting height	mm	1320	1790	1870
Insulation thickness	mm	50	75	50

Item	Description	Code
	Single electrode electronic anode - 200/300/500/1000	0ANOELET01
	Thermostat and thermometer kit	0KTERMTE00

Item	Description	Code
	3 kW heating element kit 390 mm-long heating element	DKRESELE02

Potenza scambiata, scamb. solare
Exch. power, solar coil

$T_{in,coil} = 80\text{ }^{\circ}\text{C}$; $T_{serb,in} = 10\text{ }^{\circ}\text{C}$, $T_{serb,out} = 45\text{ }^{\circ}\text{C}$

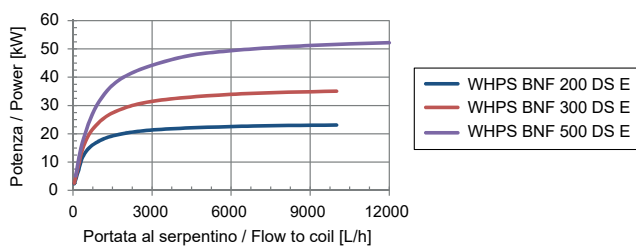

Potenza scambiata, scamb. solare
Exch. power, solar coil

$T_{in,coil} = 70\text{ }^{\circ}\text{C}$; $T_{serb,in} = 10\text{ }^{\circ}\text{C}$, $T_{serb,out} = 45\text{ }^{\circ}\text{C}$

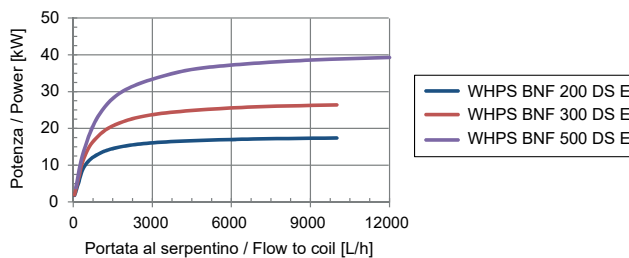

Potenza scambiata, scamb. solare
Exch. power, solar coil

$T_{in,coil} = 60\text{ }^{\circ}\text{C}$; $T_{serb,in} = 10\text{ }^{\circ}\text{C}$, $T_{serb,out} = 45\text{ }^{\circ}\text{C}$

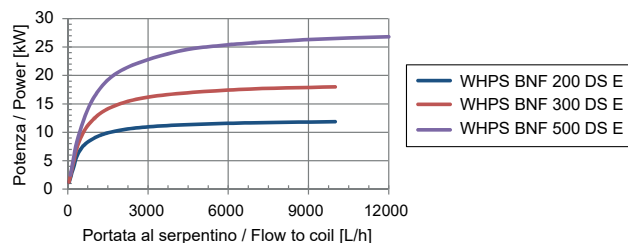

Potenza scambiata, scamb. solare
Exch. power, solar coil

$T_{in,coil} = 50\text{ }^{\circ}\text{C}$; $T_{serb,in} = 10\text{ }^{\circ}\text{C}$, $T_{serb,out} = 45\text{ }^{\circ}\text{C}$

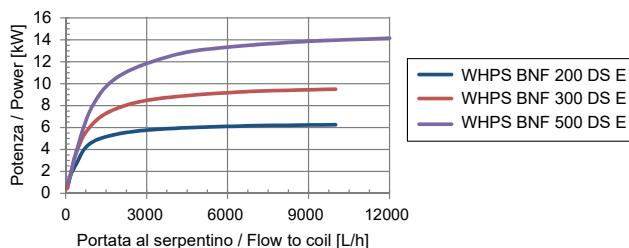

Potenza scambiata, scamb.integr.
Exch. power, integr.coil

$T_{in,coil} = 80\text{ }^{\circ}\text{C}$; $T_{serb,in} = 10\text{ }^{\circ}\text{C}$, $T_{serb,out} = 45\text{ }^{\circ}\text{C}$

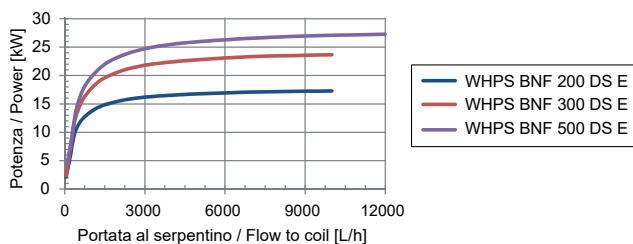

Potenza scambiata, scamb.integr.
Exch. power, integr.coil

$T_{in,coil} = 70\text{ }^{\circ}\text{C}$; $T_{serb,in} = 10\text{ }^{\circ}\text{C}$, $T_{serb,out} = 45\text{ }^{\circ}\text{C}$

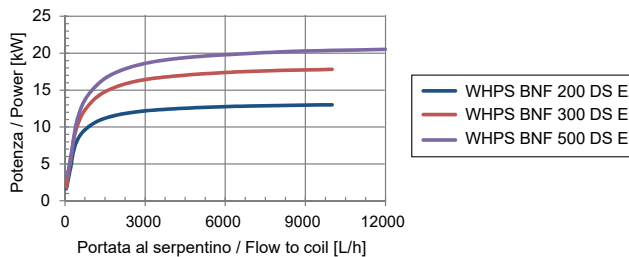

Potenza scambiata, scamb.integr.
Exch. power, integr.coil

$T_{in,coil} = 60\text{ }^{\circ}\text{C}$; $T_{serb,in} = 10\text{ }^{\circ}\text{C}$, $T_{serb,out} = 45\text{ }^{\circ}\text{C}$

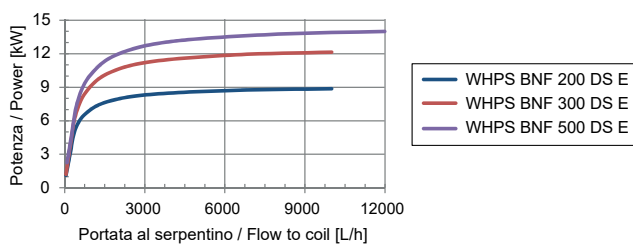

Potenza scambiata, scamb.integr.
Exch. power, integr.coil

$T_{in,coil} = 50\text{ }^{\circ}\text{C}$; $T_{serb,in} = 10\text{ }^{\circ}\text{C}$, $T_{serb,out} = 45\text{ }^{\circ}\text{C}$

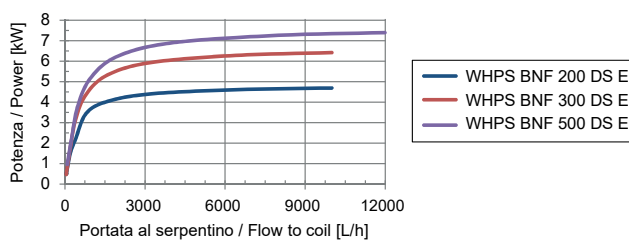

Perdite di carico sul serp. solare
Solar coil press. drop

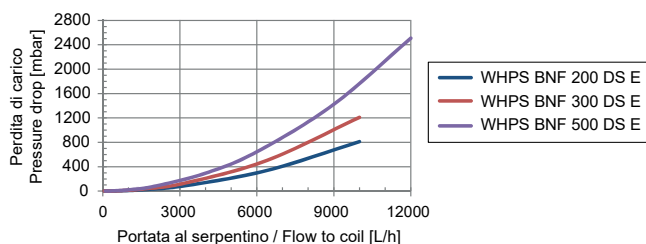

Perdite di carico sul serp. integr.
Integr. coil press. drop

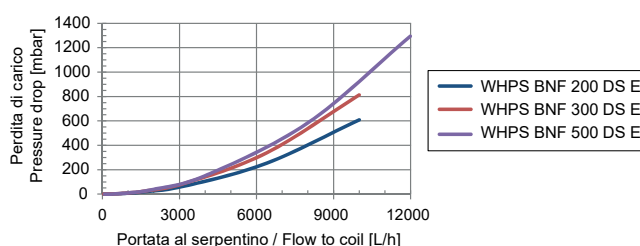

WHPS BA SS

HOT WATER STORAGE TANK THAT CAN BE COMBINED WITH HEATING-ONLY BOILERS FOR THE PRODUCTION OF DOMESTIC HOT WATER, IN PORCELAIN-GLASS STEEL WITH SINGLE COIL



- ▶ **Inspection flange**
- ▶ **High efficiency and low operating costs**
- ▶ **Fast storage with supply of abundant and continuous water**
- ▶ **Can be integrated with solar systems**

-) Insulation in soft expanded polyurethane, CFC and HCFC free
-) External case in white skai
-) Magnesium protection anode for up to 1000 litre capacity
-) Protection electrodes with electronic device for 1500 and 2000 litre capacity
-) Front inspection flange
-) DHW recirculation
-) Presetting for auxiliary resistor (thread G 1 1/2)
-) Optional kit with flange and heating element for 200 - 300 - 500 models



Available in the following capacities (l):

from 200 to 2000

Model	Code	Dissipation S	Hot water storage	Energy efficiency class	Overall height	Outer diameter	Gross weight
		W	litres		mm	mm	
BA 200 SS	PSBOLLV054	67	196	C	1215	600	90
BA 300 SS	PSBOLLV055	85	273	C	1615	600	115
BA 500 SS	PSBOLLV056	112	475	C	1705	750	155
BA 1000 SS AE	PSBOLLV069	142	930	complying with Regulation 814/2013	2205	990	245
BA 2000 SS AE	PSBOLLV070	186	1950	complying with Regulation 814/2013	2470	1300	410

Model		BA 200 SS	BA 300 SS	BA 500 SS	BA 1000 SS AE	BA 2000 SS AE
Nominal volume	litres	200	300	500	1000	2000
Maximum working pressure	bar	10				
Maximum working temperature	°C	95				
Coil area	m ²	1,5	1,8	2,2	3,5	4,3
Coil power (ΔT 35 K)	kW	36	44	55	88	112
Tilting height	mm	1375	1735	1900	2250	2580
Insulation thickness	mm	50	50	50	100	100

Item	Description	Code	Item	Description	Code
	Single electrode electronic anode - 200/300/500/1000	0ANOELET01		3 kW heating element kit 390 mm-long heating element	DKRESELE02
	Thermostat and thermometer kit	OKTERMTE00		Resistor with flange and single-phase power supply - 200/300/500 - 3kW	PSRESELE13

WHPS BZ DS

SOLAR HOT WATER STORAGE TANK WITH INTEGRATED SOLAR GROUP



- ▶ **Inspection flange**
- ▶ **Thicker 70 mm insulation**
- ▶ **Fast storage with supply of abundant and continuous water**
- ▶ **Can be integrated with solar systems**
 -) Insulation in stiff expanded polyurethane, CFC and HCFC free
 -) External case in white skai
 -) Magnesium protection anode for up to 1000 litre capacity
 -) Front inspection flange
 -) DHW recirculation
 -) Presetting for auxiliary resistor (thread G 1 1/2)



Available in the following capacities (l):

from 200 to 300

WHPS BZ DS is a hot water storage tank that can be combined with boilers for CH only, to produce domestic hot water, in porcelain-glass steel with double coil with integrated high-efficiency solar hydraulic unit.

Model	Code	Dissipation S	Hot water storage	Backup volume	Circulation pump power	Energy efficiency class	Overall height	Outer diameter	Gross weight
		W	litres	Vbu	W		mm	mm	kg
BZ 200 DS	AVBZ0MD200	51	196	67	45	B	1215	640	88
BZ 300 DS	AVBZ0MD300	63	273	85	45	B	1615	640	117

Model		BZ 200 DS	BZ 300 DS
Nominal volume	litres	200	300
Maximum working pressure	bar	10	
Maximum working temperature	°C	95	
Auxiliary coil area	m ²	0,7	0,9
Solar coil area	m ²	1	1,1
Coil power (ΔT 35 K)	kW	17	22
Solar coil power (ΔT 35 K)	kW	24	26
Tilting height	mm	1335	1725
Insulation thickness	mm	70	70

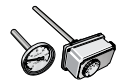
Item	Description	Code
	Single electrode electronic anode - 200/300/500/1000	0ANOELET01
	Thermostat and thermometer kit	0KTERMTE00

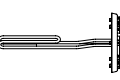
Item	Description	Code
	3 kW heating element kit 390 mm-long heating element	DKRESELE02
	Resistor with flange and single-phase power supply - 200/300/500 - 3kW	PSRESELE13

WHPS PU S

SINGLE-COIL STEEL PUFFER FOR HEATING SYSTEMS, WITH OUTER COATING IN WHITE SKAY



- › **Easy installation**
- › **High efficiency and low operating costs**
- › **Can be integrated with solar systems**
 -) Insulation in soft expanded polyurethane, CFC and HCFC free
 -) External case in white skai
 -) Control probes and heating circuit connections



Available in the following capacities (l):



Model	Code	Total volume	Overall height	Outer diameter	Net weight
		litres	mm	mm	kg
PU 2000 S	PSBOLLV015	2000	2195	1400	330,00
PU 3000 S	PSBOLLV016	3000	2750	1450	430,00

Model		PU 2000 S	PU 3000 S
Nominal volume	litres	2000	3000
Maximum working pressure	bar	10	
Maximum working temperature	°C	95	
Coil area	m ²	4,2	4,2
Coil power (80/60)	kW	120	120
Tilting height	mm	2710	2985
Insulation thickness	mm	100	100

PRODUCT AVAILABLE WHILE STOCKS LAST

WHPS BA DS

HOT WATER STORAGE TANK THAT CAN BE COMBINED WITH HEATING-ONLY BOILERS FOR THE PRODUCTION OF DOMESTIC HOT WATER, IN PORCELAIN-GLASS STEEL WITH DOUBLE COIL



- ▶ **Inspection flange**
- ▶ **High efficiency and low operating costs**
- ▶ **Fast storage with supply of abundant and continuous water**
- ▶ **Can be integrated with solar systems**

-) Insulation in soft expanded polyurethane, CFC and HCFC free
-) External case in white skai
-) Magnesium protection anode for up to 1000 litre capacity
-) Protection electrodes with electronic device for 1500 and 2000 litre capacity
-) Front inspection flange
-) DHW recirculation
-) Three holders for temperature probes (standard for models 200 - 300 - 500), other models are preset for two holders (G 1/2 fitting)
-) Ready for resistor with G 1 1/2 fitting for 1000 - 2000 models
-) Optional kit with flange and heating element for 200 - 300 - 500 models





Available in the following capacities (l):

from 200 to 2000

Model	Code	Dissipation S	Hot water storage	Backup volume	Energy efficiency class	Overall height	Outer diameter	Gross weight
		W	litres	Vbu		mm	mm	kg
BA 200 DS	PSBOLLV050	67	196	67	C	1215	600	95
BA 300 DS	PSBOLLV051	85	273	85	C	1615	600	130
BA 500 DS	PSBOLLV052	112	475	130	C	1705	750	170
BA 1000 DS AE	PSBOLLV067	142	930	350	complying with Regulation 814/2013	2205	990	265
BA 2000 DS AE	PSBOLLV068	186	1950	840	complying with Regulation 814/2013	2470	1300	480

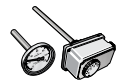
Model		BA 200 DS	BA 300 DS	BA 500 DS	BA 1000 DS AE	BA 2000 DS AE
Nominal volume	litres	200	300	500	1000	2000
Maximum working pressure	bar	10				
Maximum working temperature	°C	95				
Auxiliary coil area	m ²	0,5	1,1	1,3	1,6	2,8
Solar coil area	m ²	1,5	1,8	2,2	3	4,6
Coil power (ΔT 35 K)	kW	12	26	33	40	73
Solar coil power (ΔT 35 K)	kW	36	44	55	75	120
Tilting height	mm	1375	1735	1900	2250	2580
Insulation thickness	mm	50	50	50	100	100

Item	Description	Code
	Single electrode electronic anode - 200/300/500/1000	OANOLET01
	Thermostat and thermometer kit	OKTERMTE00

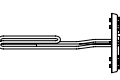
Item	Description	Code
	3 kW heating element kit 390 mm-long heating element	DKRESELE02
	Resistor with flange and single-phase power supply - 200/300/500 - 3kW	PSRESELE13

The manufacturer reserves the right to make any modifications deemed necessary without prior notification.

Uff. Pub. Fondital - CTC 03 C 525 - 08 Aprile 2024 (04/2024)

FONDITAL S.p.A. Società a unico socio

Via Cerreto, 40

25079 VOBARNO (Brescia) Italia

Tel.: +39 0365 878.31 - Fax: +39 0365 878.304

E-mail: info@fondital.it - Web: www.fondital.com



9 P C E N 0 3 C 5 2 5

COMPANY WITH
MANAGEMENT SYSTEM
CERTIFIED BY DNV
ISO 9001 • ISO 14001
ISO 45001 • ISO 50001