

Mood Aleternum®



STYLE: MIDNIGHT BLUE



STYLE: LIGHT SHELL



Low thermal inertia



Low water content



Versatility



16
bar

Maximum working pressure



Available in 17 colours



Radiator Mood: with decoration

The Mood model with supporting feet is supplied with centre distances from 1000 to 2000 mm. The supporting feet for this model only have an aesthetic function. The radiator must be secured to the wall with brackets.



For technical reasons, in order to ensure the internal Aleternum protection, it is suggested to purchase batteries in the composition needed. Disassembling batteries is strongly not recommended.

All models **Mood** are guaranteed **15 years** from installation date on manufacturing faults, provided that the installation has been performed in compliance with the current norms and respecting the instructions relating to the installation, the correct use and the correct maintenance as illustrated on this catalogue.

Standard supply	235 - 335 - 350 - 435 500 - 535 - 600	from 4 to 20 elements
	685 - 700 - 800 - 835	from 4 to 16 elements
	900 - 935 - 1000 - 1135 1200 - 1400 - 1435 - 1600 1735 - 1800 - 1935 - 2000	from 4 to 9 elements
Colours	see colours table	
Maximum working pressure	16 bar	
Test pressure	24 bar	
Aleternum treatment	Supplied as standard	

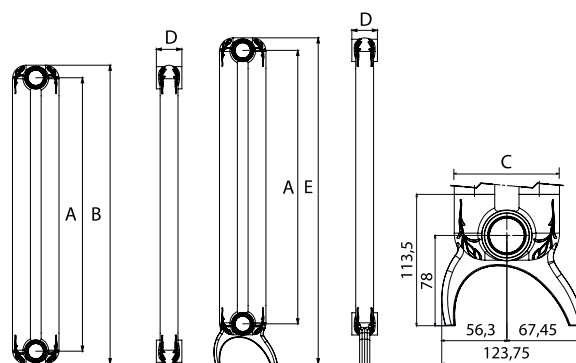

MEASURES EXPRESSED IN MILLIMETRES
With supporting foot E = B + 54 mm

Model	Heat output					
	$\Delta T 20$ W/sect.	$\Delta T 30$ W/sect.	$\Delta T 40$ W/sect.	$\Delta T 50$ W/sect.	$\Delta T 60$ W/sect.	$\Delta T 70$ W/sect.
235	9,6	16,0	23,1	30,6	38,6	46,9
335	12,5	21,1	30,5	40,5	51,1	62,3
350	13,0	21,8	31,5	41,9	52,9	64,4
435	15,2	25,6	37,1	49,4	62,5	76,1
500	16,9	28,5	41,3	55,1	69,7	85,0
535	17,8	30,1	43,6	58,2	73,6	89,8
600	19,5	32,9	47,8	63,8	80,8	98,6
685	21,6	36,6	53,3	71,2	90,2	110,2
700	22,0	37,3	54,2	72,5	91,8	112,2
800	24,5	41,6	60,6	81,1	102,8	125,8
835	25,4	43,1	62,8	84,1	106,7	130,5
900	27,0	45,9	67,0	89,7	113,9	139,3

Model	Heat output					
	$\Delta T 20$ W/sect.	$\Delta T 30$ W/sect.	$\Delta T 40$ W/sect.	$\Delta T 50$ W/sect.	$\Delta T 60$ W/sect.	$\Delta T 70$ W/sect.
935	27,9	47,5	69,2	92,7	117,7	144,0
1000	29,6	50,3	73,4	98,3	124,9	152,8
1135	33,0	56,2	82,0	110,0	139,8	171,2
1200	34,6	59,9	87,5	115,7	149,3	182,8
1400	39,7	67,9	99,2	133,3	169,6	207,9
1435	40,7	69,5	101,6	136,4	173,5	212,7
1600	45,1	77,1	112,6	151,2	192,3	235,6
1735	48,9	83,4	121,8	163,4	207,8	254,6
1800	50,7	86,4	126,3	169,4	215,4	263,9
1935	54,5	92,9	135,7	181,9	231,3	283,3
2000	56,4	96,1	140,2	188,1	239,0	292,7

Model	Depth	Height *	Centre distance	Length	Connection diameters	Water capacity	Exponent	Coefficient
	(C) mm	(B) mm	(A) mm	(D) mm/sect.	inches	litres/sect.	n	Km
235	90	284	235	50	G1	0,43	1,2665	0,2158
335	90	384	335	50	G1	0,58	1,2792	0,2718
350	90	399	350	50	G1	0,71	1,2800	0,2799
435	90	484	435	50	G1	0,85	1,2849	0,3243
500	90	549	500	50	G1	0,95	1,2885	0,3566
535	90	584	535	50	G1	1,00	1,2905	0,3734
600	90	649	600	50	G1	1,10	1,2942	0,4037
685	90	734	685	50	G1	1,15	1,2990	0,4418
700	90	749	700	50	G1	1,18	1,2999	0,4484
800	90	849	800	50	G1	1,34	1,3055	0,4907
835	90	884	835	50	G1	1,38	1,3075	0,5050
900	90	949	900	50	G1	1,50	1,3091	0,5353
935	90	984	935	50	G1	1,56	1,3100	0,5514
1000	90	1049	1000	50	G1	1,66	1,3115	0,5812
1135	90	1184	1135	50	G1	1,88	1,3149	0,6420
1200	90	1249	1200	50	G1	1,98	1,3164	0,6709
1400	90	1449	1400	50	G1	2,28	1,3213	0,7583
1435	90	1484	1435	50	G1	2,36	1,3210	0,7771
1600	90	1649	1600	50	G1	2,60	1,3192	0,8673
1735	90	1784	1735	50	G1	2,85	1,3178	0,9430
1800	90	1849	1800	50	G1	2,95	1,3171	0,9801
1935	90	1984	1935	50	G1	3,10	1,3156	1,0585
2000	90	2049	2000	50	G1	3,22	1,3150	1,0970

* To calculate the height of the radiator with the supporting foot (E), add 54 mm to the height of the radiator without foot (B)

Maximum working pressure: 1600 kpa (16 bar) Maximum working temperature: 120 °C

Characteristic equation of the model $\Phi = Km \Delta T^n$

The thermal efficiency values shown comply with the European Standard EN 442-1:2014 and are certified by the MRT Lab of the Milan Polytechnic, notified body №1695.

CODE OBTAINING EXAMPLE

Mood radiator 600 from 10 sections PURE WHITE RAL 9010 colour
Ex: **EA10C0 + 04 + 10**

Mood radiator 600 from 12 sections SILVER colour
Ex: **EA10C0 + 07 + 12**

To obtain the radiator code, it is necessary to add the code to the four final digits relating to the colour and number of elements.

Model	Code
235	EA11A0 xx xx
335	EA11B0 xx xx
350	EA10A0 xx xx
435	EA11C0 xx xx
500	EA10B0 xx xx
535	EA11D0 xx xx
600	EA10C0 xx xx
685	EA11E0 xx xx
700	EA10D0 xx xx
800	EA10E0 xx xx
835	EA11F0 xx xx
900	EA10F0 xx xx







Model	Code
935	EA11G0 xx xx
1000	EA10G0 xx xx
1135	EA11H0 xx xx
1200	EA10H0 xx xx
1400	EA10I0 xx xx
1435	EA11I0 xx xx
1600	EA10L0 xx xx
1735	EA11L0 xx xx
1800	EA10M0 xx xx
1935	EA11M0 xx xx
2000	EA10N0 xx xx

Model with support	Code
1000	EA30G0 xx xx
1135	EA31H0 xx xx
1200	EA30H0 xx xx
1400	EA30I0 xx xx
1435	EA31I0 xx xx
1600	EA30L0 xx xx
1735	EA31L0 xx xx
1800	EA30M0 xx xx
1935	EA31M0 xx xx
2000	EA30N0 xx xx

COLOURS

See table on the following page

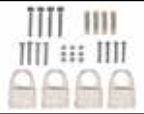
Item	Description	Colour	Code
	Fixing kit with pincers + plugs and adapters: 1 Flat ½ bleed valve 2 Plastic covers 1 Flat ½ plug 2 ½ Rh adapters 2 ½ Lh adapters 3 Metal sheet brackets 3 White plastic covers 3 Rh pincers 3 Lh pincers 4 1" O-ring seals 1 Retainer rubber cap	PURE WHITE RAL 9010	550122
		NEUTRAL WHITE	55012206
		SILVER	55012207
		BRONZE	55012208
		LIGHT SHELL	55012209
		LIGHT GREY	55012210
		MIDNIGHT BLUE	55012211
		MIDNIGHT GREEN	55012212
		CHOCOLATE	55012213
		CINNAMON	55012214
		DUSTY ROSE	55012215
		FOREST GREEN	55012216
		THE FONDITAL RED	550122BL
		SLATE GREY	550122E
		BLACK RAVEN	550122L
		GRAPHITE	550122R
BLACK COFFEE	550122V		

Item	Description	Code
	Towel rail kit with decoration of 237 mm	570125
	Towel rail kit with decoration of 337 mm	570126
	Towel rail kit with decoration of 437 mm	570127
	Towel rail kit with decoration of 537 mm	570128
	A 30/2 Lockshield plug for Mood - Tribeca 50 mm (water diaphragm)	521011M
	A 32/1 O-ring seal for nipples, plugs and adapters	530102
	A 33/1 Nipple for home furnishing radiators	521012
	A 74 Fixing kit for horizontal installation, colour white n° 4	550120
	A 75 Fixing kit for horizontal installation, colour white n° 4	550121

CLASSIC

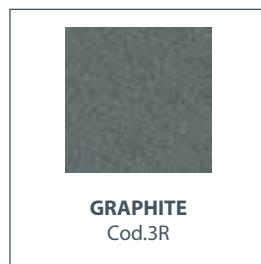
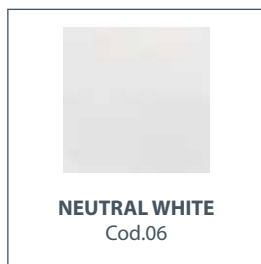
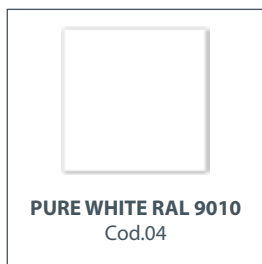

Coloured versions: price increase 35% of a PURE WHITE RAL 9010 for the colours CLASSIC

STYLE



SPECIAL



The colours shown are merely indicative and not binding, as they may slightly differ, due to the printing process.

Coloured versions: price increase 45% of a PURE WHITE RAL 9010 for the colours STYLE and SPECIAL

