



# fondital

PROCIDA AWS  
X4 - X6 - X8 - X10

IST 03 J 048 - 02

## INSTALLATION MANUAL

### SPLIT AIR/ WATER HEAT PUMP

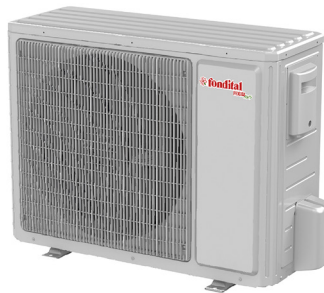

# EN

Translation of the  
original instructions  
(in Italian)

Thank you for choosing a heat pump by Fondital. Carefully read this Manual before using the unit and keep it for future reference.

## For users

Thank you for choosing a product by Fondital. In order to use the product correctly, please carefully read this instruction manual before installation and use. To achieve the intended operation of the air conditioner, please follow the recommendations below for the proper installation and use of the product:

1. Installation, use and maintenance of this appliance must be carried out by specially trained technical personnel. During operation, the safety instructions on labels, in the User manual and other documents must be strictly complied with. The appliance can be used by children aged 8 years and over and by persons with physical, sensory and cognitive impairments, or lacking appropriate experience and knowledge provided that they are supervised or have been instructed in the safe use of the appliance and understood the associated dangers. Do not allow children to play with the appliance. Cleaning and maintenance must not be carried out by children without proper supervision.
2. This product underwent a strict inspection and operating tests before leaving the factory. In order to avoid damage due to improper disassembly and inspection, which could affect the normal operation of the unit, do not disassemble it yourself. If necessary, contact our company's authorised service centre.
3. Our company shall not be liable for personal injury, loss or damage to property caused by improper use, including improper installation and debugging procedures, unnecessary maintenance, violation of applicable national laws, regulations and industry standards, and failure to follow this instruction manual.
4. If the product is faulty and can not be used, please contact our service centre as soon as possible and provide the following details.
  - » Contents of the product nameplate: product code, model, cooling/heating capacity, serial number, date of manufacture (Manufactured Date).
  - » Malfunction condition (specify the situations before and after the error is displayed).
5. All drawings and data in this instruction manual are provided for reference only. The product is subject to continuous improvements and innovations aimed at optimising its quality. We reserve the right to make any necessary changes to the product at any time for commercial or production reasons, as well as to revise the contents of the manual without prior notice.

<b>1.</b>	<i>Diagram of the operating principle</i>	<b>11</b>
<b>2.</b>	<b>HEATING AND COOLING AND DHW WITH CIRCUIT BREAKER</b>	<b>12</b>
<b>3.</b>	<i>Unit operating principle</i>	<b>14</b>
<b>4.</b>	<i>Name</i>	<b>16</b>
<b>5.</b>	<i>Installation example</i>	<b>17</b>
<b>6.</b>	<i>Key components</i>	<b>20</b>
6.1	<i>Indoor unit</i>	<b>20</b>
6.2	<i>Outdoor unit</i>	<b>22</b>
<b>7.</b>	<i>Guidelines for outdoor unit installation</i>	<b>23</b>
7.1	<i>Instructions for the installation</i>	<b>24</b>
7.2	<i>Outdoor unit installation</i>	<b>24</b>
<b>8.</b>	<i>Indoor unit installation</i>	<b>26</b>
8.1	<i>Choosing the position for indoor unit installation</i>	<b>26</b>
8.2	<i>Clearances to be observed when installing the indoor unit (mm)</i>	<b>27</b>
8.3	<i>Indoor unit external dimensions</i>	<b>28</b>
8.4	<i>Precautions for indoor unit installation</i>	<b>28</b>
8.5	<i>Water volume and pump capacity</i>	<b>28</b>
8.6	<i>Water volume and pressure in the expansion tank</i>	<b>29</b>
8.7	<i>Selecting the expansion tank</i>	<b>29</b>
<b>9.</b>	<i>Piping connection</i>	<b>30</b>
9.1	<i>Connecting the outlet pipe for indoor unit and outdoor unit</i>	<b>30</b>
9.2	<i>Applying a protection layer to the connecting pipe</i>	<b>30</b>
<b>10.</b>	<i>Remote ambient temperature sensor</i>	<b>32</b>
<b>11.</b>	<i>Thermostat</i>	<b>33</b>
<b>12.</b>	<i>2-way valve</i>	<b>33</b>
<b>13.</b>	<i>3-way valve</i>	<b>34</b>
<b>14.</b>	<i>Other auxiliary heat sources</i>	<b>35</b>
<b>15.</b>	<i>Door control unit</i>	<b>36</b>
<b>16.</b>	<i>Refrigerant filling and draining</i>	<b>36</b>
<b>17.</b>	<i>Collecting refrigerant</i>	<b>37</b>
<b>18.</b>	<i>Unit handling</i>	<b>37</b>
<b>19.</b>	<i>Installing a sealed storage tank</i>	<b>38</b>
19.1	<i>Installation sizes</i>	<b>38</b>
19.2	<i>Connection of the hydraulic system</i>	<b>39</b>
19.3	<i>Electrical connection</i>	<b>39</b>
<b>20.</b>	<i>Wiring diagram</i>	<b>41</b>
20.1	<i>Control board (Indoor unit)</i>	<b>41</b>
20.2	<i>Electrical connections</i>	<b>47</b>
<b>21.</b>	<i>Commissioning</i>	<b>55</b>
21.1	<i>Checks before start-up</i>	<b>55</b>
21.2	<i>Operation test</i>	<b>56</b>
<b>22.</b>	<i>Operation and routine maintenance</i>	<b>57</b>
22.1	<i>Recovery</i>	<b>59</b>
22.2	<i>Decommissioning</i>	<b>59</b>
22.3	<i>Safety notes</i>	<b>60</b>
22.4	<i>Precautions before seasonal use</i>	<b>61</b>

## Safety warnings (to be strictly adhered to)



**WARNING:** failure to follow these instructions could result in serious damage to the unit or injury to persons.



**NOTE:** failure to follow these instructions could result in minor or moderate damage to the unit or injury to persons.



This sign indicates that operation must be prohibited. Incorrect operation may cause serious damage or be life-threatening.



This signal pinpoints some conditions that must be complied with. Incorrect operation can cause damage to people or property.

## NOTE

Upon receipt of the unit, check its appearance, verify the model and parts supplied, and ensure that everything is as ordered. The design and installation of the unit must be carried out by authorised personnel, in accordance with current laws and regulations and with these instructions.

After installation, the unit may only be put into operation if there are no problems to check.

After normal use, carry out the specified periodic cleaning and maintenance procedures to ensure trouble-free operation and long life of the unit.

If the power cable is damaged, it must be replaced by the manufacturer, its service agent or similarly qualified persons in order to avoid danger.

The unit must be installed in accordance with national wiring regulations.

This product is a general-purpose air conditioner and must not be installed in the presence of corrosive, explosive, flammable or polluting substances because use under such conditions would cause malfunctions, a shorter service life, fire hazard and risk of serious injury to persons. Special air conditioners must be used under the above-mentioned conditions.



This marking means that the product must not be disposed of as household waste in EU countries. Recycle the product with a sense of responsibility to promote sustainable reuse of resources and avoid any damage to the environment or human health resulting from uncontrolled disposal of waste. To return the used appliance, rely on sorted waste systems or contact the dealer where appliance was purchased. The dealer could take the product and recycle it in an environment-friendly manner.

R32:675





## WARNING

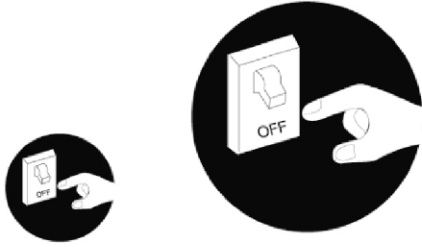

In the event of anomalies, such as a smell of something burning, immediately switch off the unit and contact a service centre.  
If the anomaly persists, the unit may be damaged and an electric shock or fire may occur.



Do not operate the unit with wet hands.  
Non-compliance could result in an electric shock hazard.



Before installation, check that the mains voltage corresponds to the values indicated on the unit's rating plate and that the capacity of the electrical system, power cable or electrical outlet is compatible with the unit's power requirements.

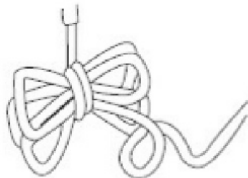

A special power supply circuit must be used to avoid fire hazards.  
Do not use multiple sockets or extension cords for connecting the cables.

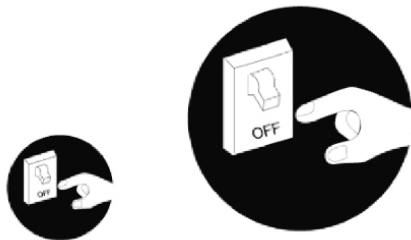

When the unit is left unused for a long period, unplug it and empty the indoor unit and the water storage tank.

Non-compliance may result in the dust building up causing a risk of overheating, fire or (in winter) freezing of the storage tank or coaxial heat exchanger.



Do not damage the electrical cable or use a cable that does not comply with the specifications.

Non-compliance may result in overheating or fire.

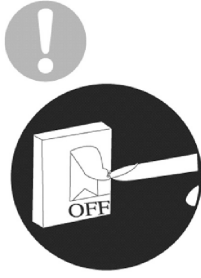

Before cleaning the unit, disconnect it from the mains.  
Non-compliance could result in risk of an electric shock or damage to property.

The power supply must adopt a special circuit with a residual current circuit breaker and must have sufficient capacity.

The user may not replace the power cable socket without the manufacturer's prior consent. Electrical connections must be carried out by a professional. Ensure that the unit is properly connected to ground and do not change the way it is connected to ground.

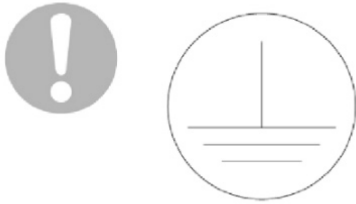

Ground: the unit must have a reliable ground connection! The ground cable must be connected to a building protection device.  
In the absence of such a device, ask a qualified technician to install one. It is also recommended not to connect the ground cable to gas pipes, water pipes, drain pipes or other improper items not approved by a professional technician.

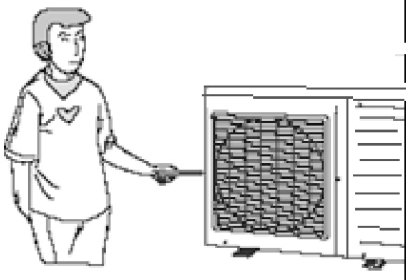

Do not insert foreign objects into the outdoor unit to avoid risk of damage. Do not insert your hands into the air outlet of the outdoor unit.

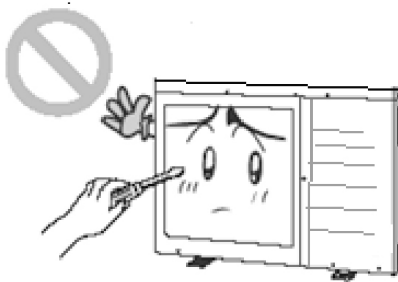

Do not attempt to repair the unit yourself.  
Improper repair may cause fire or electric shock. For this reason, it is recommended to contact a service centre for repairs.



Do not climb on the unit or place objects on it.  
This could create a falling hazard for people and objects.

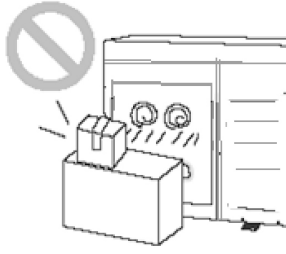

Do not obstruct the air inlet and outlet areas of the unit.  
Obstructions could reduce efficiency or cause the unit to shut down or create a fire hazard.



Keep pressurised sprays, gas cylinders and other similar objects at least 1 m away from the unit.  
Fire or explosion hazards may result.

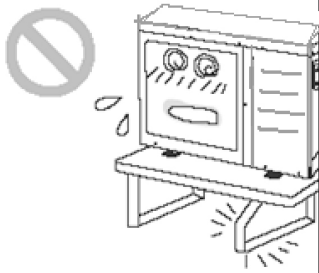

Check that the installation support is sufficiently stable.  
If it is damaged, there is a risk of the unit falling and injuring persons.

The unit should be installed in a well-ventilated place to reduce energy consumption.

When the storage tank and system circuit are empty, the unit must not be operated.



## WARNING

Do not use any means other than those recommended by the manufacturer to speed up the defrosting process or for cleaning. If a repair is necessary, contact the nearest authorised service centre. Repairs carried out by unqualified personnel could be dangerous. The outdoor unit must be stored in a room free of continuously operating ignition sources (e.g. open flames, gas appliances or electric heaters in operation). Do not pierce or burn. It contains slightly flammable R32 gas. For repairs, strictly follow the manufacturer's instructions. Note that refrigerants are odourless. Read the manual for the specific product.

The indoor unit must be located in a well-ventilated room whose dimensions correspond to those specified for operation. It must be installed, used and stored in a room having an area of at least X m<sup>2</sup> (for the measure of space X, refer to table "a" in the section "Safe use of flammable refrigerants").

If the fixed appliance is not equipped with a mains lead with a plug, or other means of disconnection from the mains supply which ensures a separation between the contacts in each pole and is capable of completely disconnecting the power supply under category III overvoltage conditions, the instructions state that such a means of disconnection must be incorporated into the fixed wiring in accordance with the regulations in force on electrical connections.

The appliance can be used by children aged 8 years and over and by persons with physical, sensory and cognitive impairments, or lacking appropriate experience and knowledge provided that they are supervised or have been instructed in the safe use of the appliance and understood the associated dangers. Do not allow children to play with the appliance. Cleaning and maintenance must not be carried out by children without proper supervision.

The appliance must not be stored in a room containing open flames (e.g. gas appliances) and ignition sources (e.g. electric stoves) that are continuously in operation.

The appliance must be stored in such a way as to prevent any mechanical damage.



## NOTE



The appliance contains slightly flammable R32 gas.



It is recommended to read the user manual before using the appliance.



Read the installation manual before installing the appliance.



Read the service manual before repairing the appliance.



The refrigerant used is R32, it is slightly flammable and odourless. It also implies risk of explosion under certain conditions. However, the flammability of the refrigerant is very low. Ignition is only possible with fire. (Open flame)

Compared to commonly used refrigerants, R32 is non-polluting and does not damage the ozone layer. This means that it also has a lower greenhouse effect. R32 has excellent thermodynamic characteristics that result in very high energy efficiency. As a result, the units require a lower filling level.

Before installation, check that the electrical power ratings at the designated location correspond to the specifications on the unit rating plate and check the reliability and safety of the electrical connection.

The unit must be connected to the mains by means of a unipolar circuit breaker suitable for category III overvoltages.

Before use, check that the electrical cables and water pipes are correctly connected to avoid water leaks, risk of electrocution and the like.

Do not operate the unit with wet hands. Children must not be allowed to use it.

In the instructions, the on/off switching descriptions refer to the use of the unit on/off button. The power supply is cut by disconnecting the unit from the mains.

Do not expose the indoor unit directly to the corrosive conditions of environments containing water or humidity.

Do not operate the unit with empty water storage tank. The air outlet/inlet openings of the outdoor unit must not be obstructed by any objects.

When the unit is not in use, the water in the unit and in the pipes must be drained to prevent the storage tank, pipes and water pump from cracking due to frost.

Never use sharp objects to press the button. Doing so could damage the manual control unit. Do not use other wires instead of the special communication line of the unit. Doing so could damage the control elements. Never clean the manual control unit with benzene, thinners or other chemicals to avoid discolouration of the surfaces and damage to the elements. Clean the unit using a cloth soaked in mild detergent. Gently clean the display screen and connecting parts to avoid discolouration.

The power cable must be separated from the communication line.

Work on the refrigerant circuit must only be carried out by persons with valid certification from an accredited body stating that they can handle refrigerants safely, in accordance with the specifications in force.

Maintenance work on the appliance must be carried out strictly in accordance with the manufacturer's instructions. Maintenance and repair work requiring the assistance of other qualified personnel must be carried out under the supervision of the person competent to handle flammable refrigerants.

<b>Maximum and minimum water temperatures</b>		
Function	Minimum water temperature	Maximum water temperature
Cooling	7°C	25°C
Central heating	20°C	60°C
Water heating (tank)	40°C	80°C
<b>Maximum and minimum water pressure values</b>		
Function	Minimum water pressure	Maximum water pressure
Cooling	0.05 MPa	0.25 MPa
Central heating		
Water heating (tank)	0.05 MPa	0.60 MPa
<b>Maximum and minimum water pressure values at inlet.</b>		
Function	Minimum water pressure at inlet	Maximum water pressure at inlet
Cooling	0.05 MPa	0.25 MPa
Central heating		
Water heating (tank)		

The external static pressures with which the appliance has been tested are stated (only additional heat pumps and appliances with additional heaters). If the power cable is damaged, it must be replaced by the manufacturer, its service agent or an equally qualified person in order to avoid danger.

The appliance is intended to be connected to the water mains permanently and not by means of connecting pipes.

If you have any questions, please contact your local dealer, an authorised service centre, a branch office or our company directly.

# 1. Diagram of the operating principle

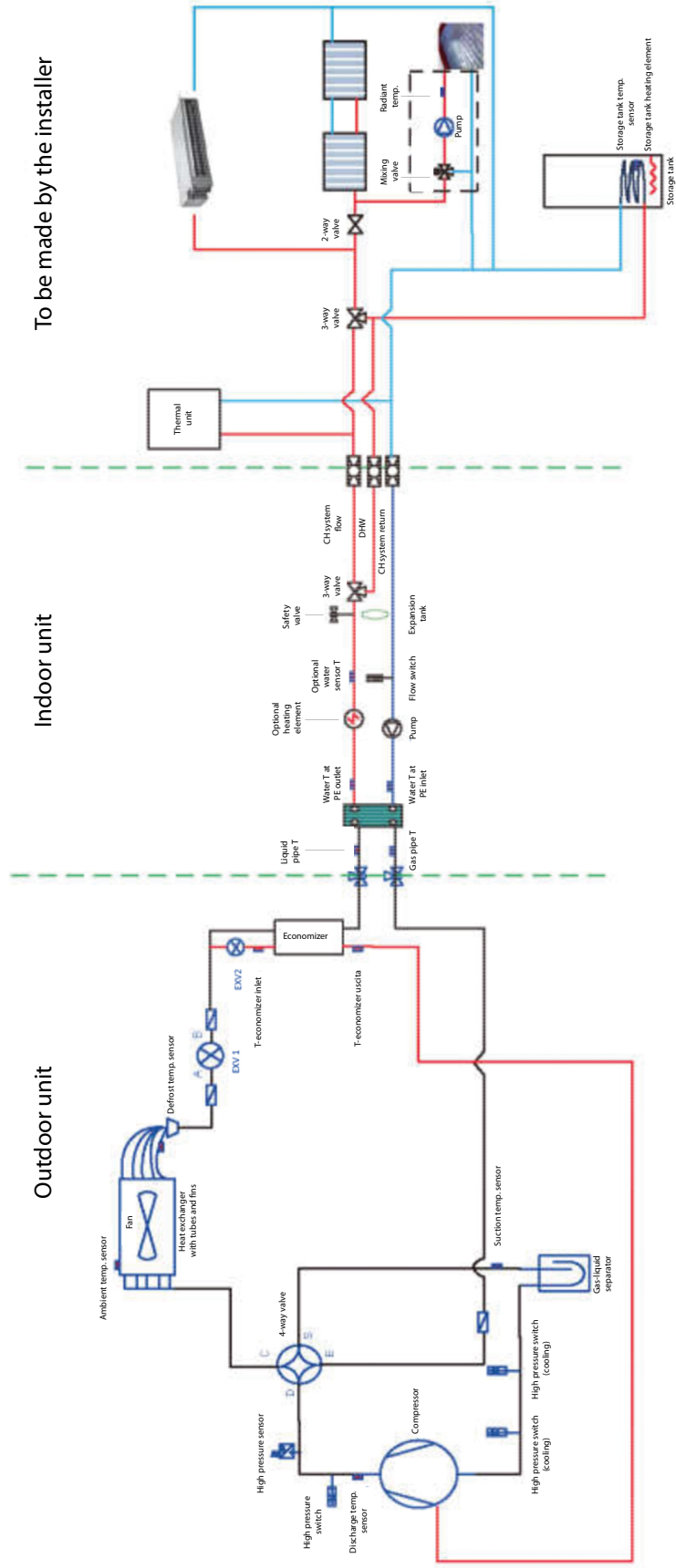

### Notes

- (a) Water mixing accessories are provided as an option. If required, please contact the manufacturer.
- (b) The 3-way valve to install on site must be controlled by the user.

## 2. HEATING AND COOLING AND DHW WITH CIRCUIT BREAKER

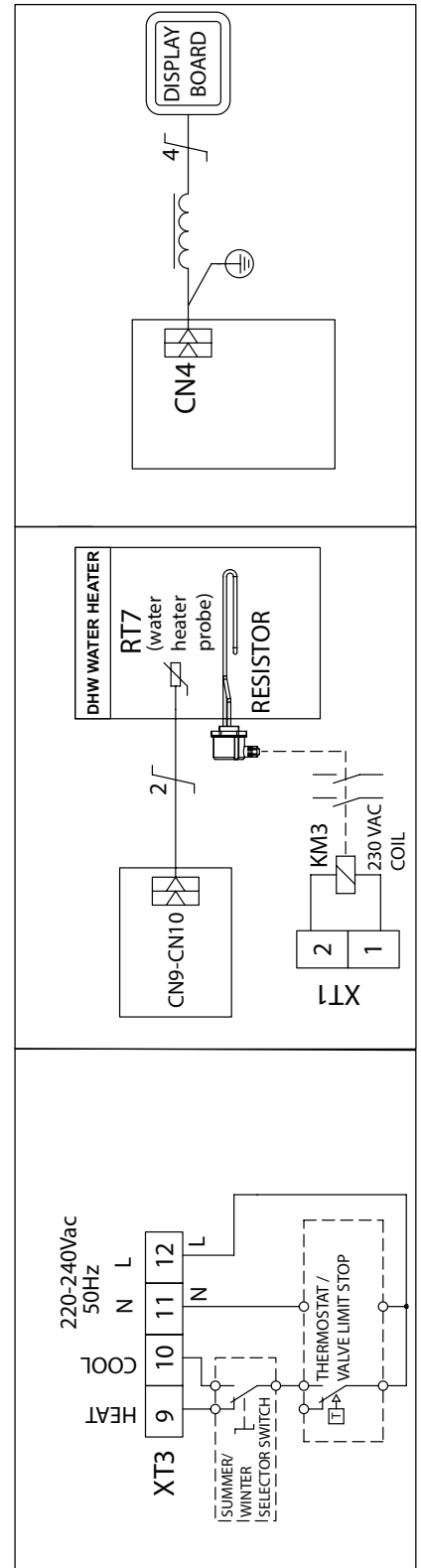
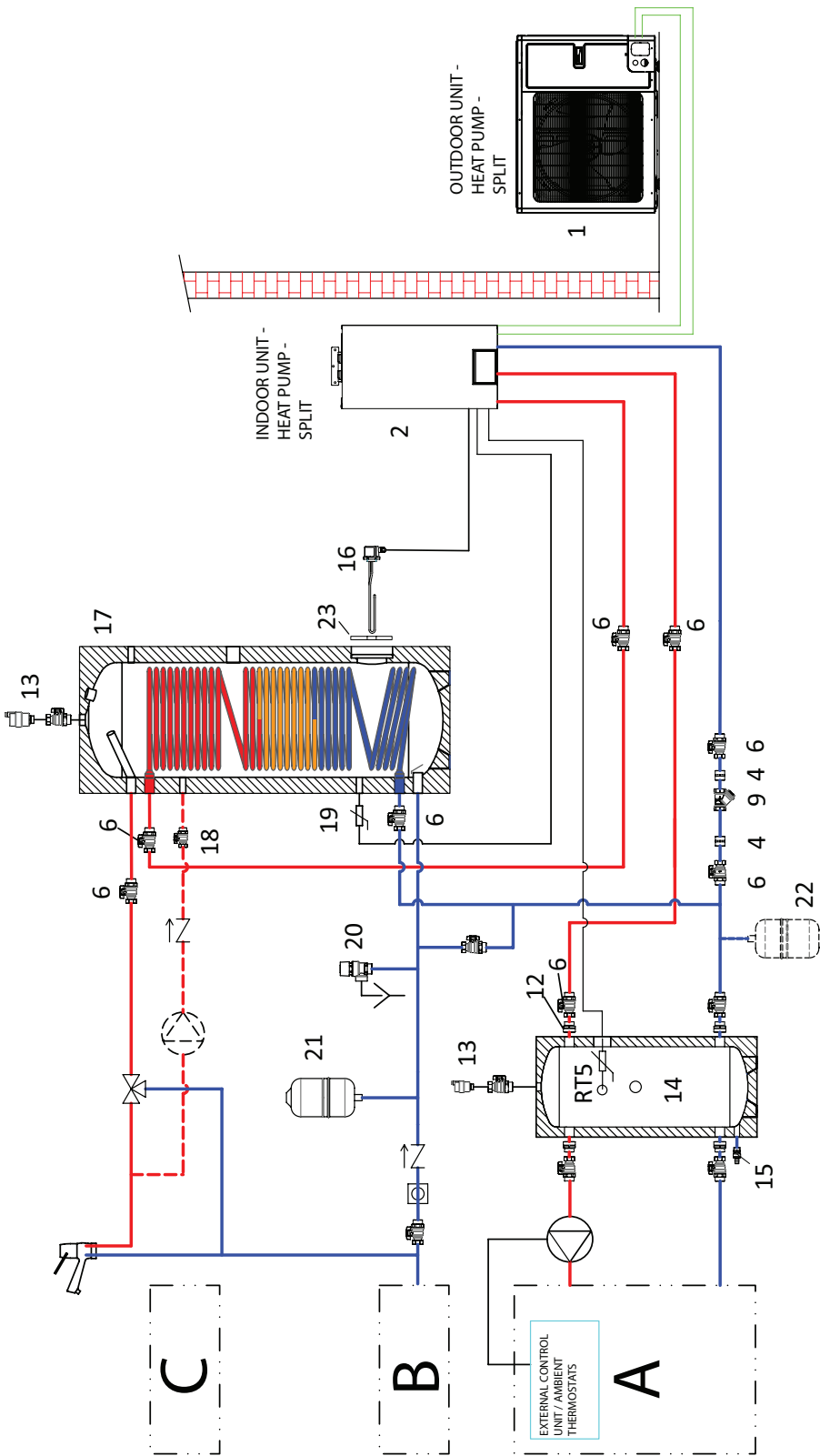

Ref	Description	Notes
A	Heating / cooling system	-
B	Hydraulic network	-
C	Recirculation	-
1	Outdoor unit	-
2	Indoor unit	-
4	1" M-M fittings	(**)
6	1" M-F taps	(**)
9	1" F-F Y-shaped filter	(**)
12	1" ¼ - 1" M-M fitting	(**)
13	Bleed valve	(***)
14	WHPF PU buffer tank	(**)
15	System discharge cock.	(**)
16	Heating element	(**)
17	WHDHP SS storage tank	(**)
18	½ " tap	(***)
19	Probe	(**)
20	Safety valve.	(***)
21	DHW expansion vessel	(***)
22	Extra CH expansion tank	(***)
23	Flange with resistor fitting	(**)
RT5	Probe	(**)

(\*\*) Extra accessory

(\*\*\*) Not included in extra Fondital accessories

(\*\*\*\*) To be used if no glycol solution is added to the system water. Does not protect the heat pump in case of power failure.

The diagram is purely indicative and for descriptive purposes.

The system must be designed and validated by a qualified thermal-engineering firm.

### 3. Unit operating principle

The air/water heat pump with DC inverter consists of an outdoor unit, an indoor unit and a storage tank with internal fan coil. Functions:

- (1) Cooling;
- (2) Heat;
- (3) Hot Water;
- (4) Cool + Hot Water;
- (5) Heat + Hot Water;
- (6) Emergen. mode;
- (7) Fast Hot Water;
- (8) Holiday mode;
- (9) Force mode;
- (10) Quiet mode;
- (11) Disinfection;
- (12) Weather depend;
- (13) Floor preparation;
- (14) Air removal;
- (15) Auxiliary thermal unit.

**Cool:** in cooling mode, the refrigerant condensates inside the outdoor unit and evaporates in the indoor unit. Thanks to heat exchange with indoor unit water, water releases heat and its temperature decreases, while refrigerant absorbs heat and evaporates. Outlet temperature can be set based on user's needs, by means of a wired remote control. System low-temperature water is connected to internal fan coil and underground tube through a valve control, so as to ensure heat exchange with indoor air and decrease ambient temperature to the required value.

**Heat:** in heating mode, the refrigerant evaporates inside the outdoor unit and condensates in the indoor unit. Thanks to heat exchange with indoor unit water, water absorbs heat and its temperature increases, while refrigerant releases heat and condensates. Outlet temperature can be set based on user's needs, by means of a wired remote control. System high-temperature water is connected to internal fan coil and underground tube through a valve control, so as to ensure heat exchange with indoor air and increase ambient temperature to the required value.

**Hot Water:** in water heating mode, the refrigerant evaporates inside the outdoor unit and condensates in the indoor unit. Thanks to heat exchange with indoor unit water, water absorbs heat and its temperature increases, while refrigerant releases heat and condensates. Outlet temperature can be set based on user's needs, by means of a wired remote control. System high-temperature water is connected to internal storage tank coil through a valve control, so as to ensure heat exchange with storage tank water and increase its temperature to the required value.

**Cool + Hot Water:** when the cooling mode is combined to the water heating mode, user can set priority of either mode as required. In the preset configuration, the heat pump has top priority. In this configuration, if the cooling mode is used together with the water heating mode, the heat pump will give priority to cooling. In this case, water can only be heated up using the storage tank electric heater. In the opposite configuration, the heat pump will give priority to water heating and switch to cooling only as soon as water has been heated up.

**Heat + Hot Water:** when the heating mode is combined to the water heating mode, user can set priority of either mode as required. In the preset configuration, the heat pump has top priority. In this configuration, if the heating mode is used together with the water heating mode, the heat pump will give priority to heating. In this case, water can only be heated up using the storage tank electric heater. In the opposite configuration, the heat pump will give priority to water heating and switch to heating only as soon as water has been heated up.

**Emergen. mode:** this mode is only available for room heating and water heating. When the outdoor unit stops due to a malfunction, the corresponding emergency mode is activated. For heating mode, after the emergency mode is activated, heating can only be obtained through the electric heater of the indoor unit. When the set outlet or indoor temperature is reached, the electric heater of the indoor unit stops working. For water heating mode, the electric heater of the indoor unit stops while the electric heater of the storage tank is working. Once the set air or storage tank temperature is reached, the electric heater stops.

**Fast Hot Water:** in fast water heating mode, the unit operates on the basis of the water heating command from the heat pump and the electric heater of the storage tank also starts up simultaneously.

**Force mode:** this mode is only used for refrigerant recovery and troubleshooting of the unit.

**Holiday mode:** this mode is only available for the heating function. It can be used to maintain the indoor ambient temperature or water temperature in a certain range to prevent the unit hydraulic system from freezing or to protect certain objects from possible frost damage. When the outdoor unit stops due to a malfunction, the two electric heaters of the unit are activated.

**Disinfection:** in this mode, the water heating system can be disinfected. When you activate the disinfection function and set the corresponding time, the function is started. When the set temperature is reached, the function is turned off.

**Weather depend:** this mode is only available for the room heating or cooling function. In the climate-dependent mode, the set value (ambient air temperature or water temperature in the storage tank) is automatically measured and controlled when the outside air temperature changes.

**Quiet mode:** silent mode is available for cooling, heating and water heating functions. In Quiet mode, the outdoor unit reduces the operating noise through automatic control.

**Floor preparation:** this function is intended to periodically preheat the floor for initial use.

**Air removal:** this function aims to remove air from the hydraulic system and fill it with water to allow the unit to operate with stable water pressure.

**Solar heater:** if the conditions for starting up the solar water heater are met, it starts to heat the circulating water. The heated water then reaches the storage tank, where heat exchange with the water contained in the tank takes place. Under all conditions, the solar water heater always has start-up priority to promote energy preservation.

**Other thermal:** when the outside temperature is lower than the set value for starting the auxiliary thermal unit and, at the same time, the appliance is in an error condition and the compressor has been stopped for three minutes, the auxiliary thermal unit starts to deliver heat or hot water.

## 4. Name

The table below refers to the commercial designation identifying the outdoor unit and the indoor unit with the same power rating and power supply.

PROCIDA	A	W	S	X	4
1	2	3	4	5	6

N.	Description	Options
1	Product name	PROCIDA
2	Type of external source	A = air
3	CH system fluid type	W = water
4	Heat pump type	S = split
5	Power type	X = single-phase
6	Rated heating output	4.0 = 4,0 kW; 6.0 = 6,0 kW; 8.0 = 8,0 kW; 10 = 10 kW

The table below refers to the indoor unit.

### Indoor unit

PROCIDA	I	W	U	4
1		2		3

N.	Description	Options
1	Product name	PROCIDA
2	Unit type	IWU = indoor wall-hung unit
3	Rated heating output	4.0 = 4,0 kW; 6.0 = 6,0 kW; 8.0 = 8,0 kW; 10 = 10 kW

The table below refers to the outdoor unit.

### Outdoor unit

PROCIDA	A	W	S	4	(O)
1	2	3	4	5	6

N.	Description	Options
1	Product name	PROCIDA
2	Type of external source	A = air
3	CH system fluid type	W = water
4	Heat pump type	S = split
5	Rated heating output	4.0 = 4,0 kW; 6.0 = 6,0 kW; 8.0 = 8,0 kW; 10 = 10 kW
6	Unit type	(O) = outdoor

### Model range

Model name	Capacity		Electric power supply
	Heating <sup>1</sup> , kW	Cooling <sup>2</sup> , kW	
PROCIDA AWS X4	4	3,8	230VAC 50 Hz
PROCIDA AWS X6	6	5,8	
PROCIDA AWS X8	8	7	
PROCIDA AWS X10	9,5	8,5	

### Notes

- (a) <sup>1</sup>Power values and input power refer to the following conditions:  
Internal water temperature 30 °C/35 °C, External air temperature 7 °C DB/6 °C WB;  
DB = dry bulb / WB = wet bulb.
- (b) <sup>2</sup>Power values and input power refer to the following conditions:  
Internal water temperature 23 °C/18 °C, External air temperature 35 °C DB/24 °C WB;  
DB = dry bulb / WB = wet bulb.

### Operating scenario





Mode	External temperature (°C)	Water temperature (°C)
Central heating	- 25~35	20~60
Cooling	10~48	7~25
Water heating (tank)	- 25~45	40~80

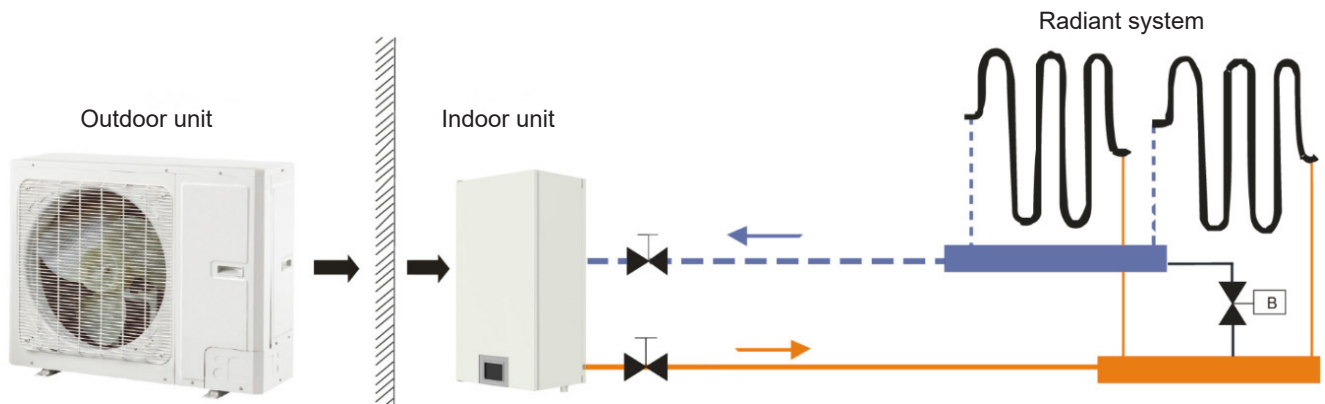

## 5. Installation example

### SCENARIO 1: Connection of an underfloor coil for heating and cooling



Symbol	Description
	Shut-off valve
	Remote ambient thermostat (provided on site)
	By-pass valve (provided on site)
	High-temperature line
	Low-temperature line

#### Notes

- (a) The two-way valve is key to avoid condensation on the floor in cooling mode;
- (b) Thermostat type and installation specifications must comply with the provisions of this manual;
- (c) The by-pass valve must be installed on manifold to ensure a sufficient water flow rate.

**SCENARIO 2: Connection of a storage tank for domestic hot water and an underfloor coil**

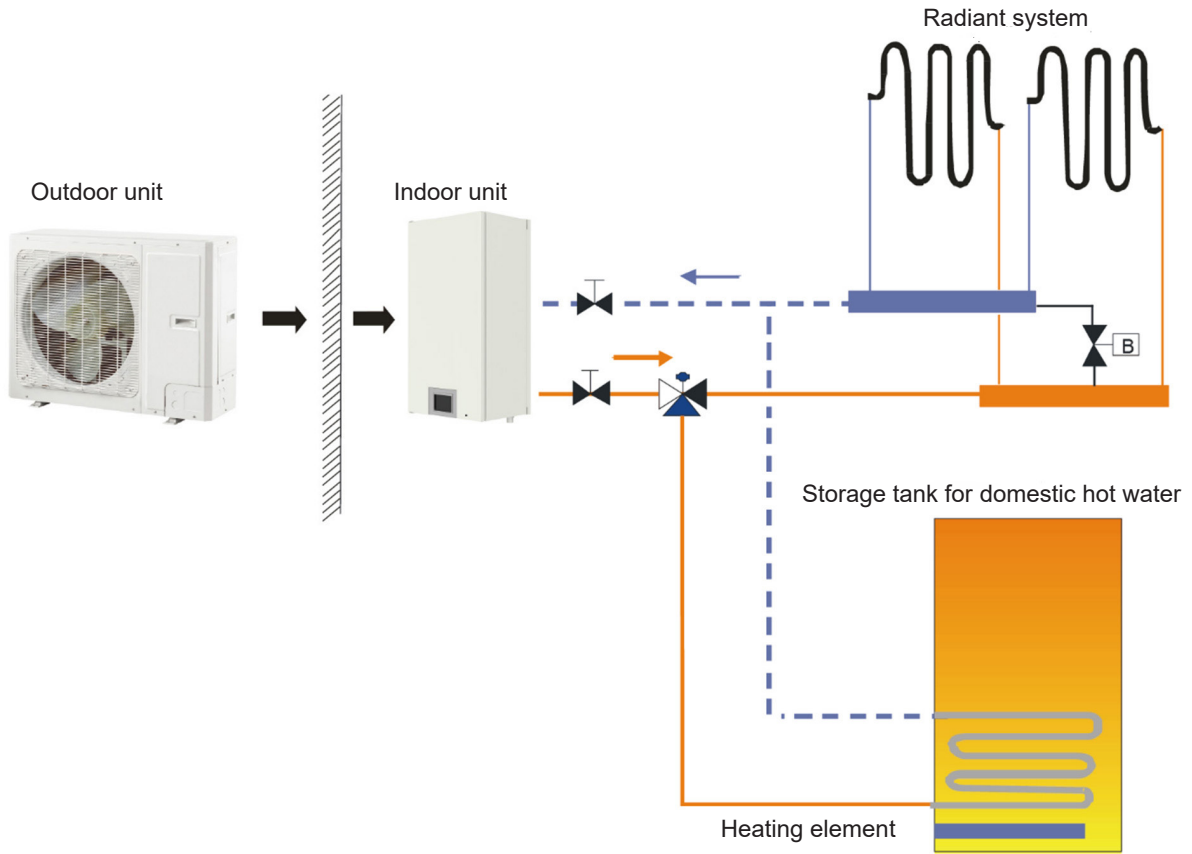

Symbol	Description
	Shut-off valve
	Remote ambient thermostat (provided on site)
	By-pass valve (provided on site)
	Three-way valve (provided on site)
	High-temperature line
	Low-temperature line

- Notes**
- (a) The two-way valve is key to avoid condensation on the floor in cooling mode.
  - (b) In this case, a three-way valve must be installed according to the instructions in this manual;
  - (c) The storage tank for domestic hot water should be equipped with an internal electric heater to ensure a sufficient heating power in very cold conditions.

**SCENARIO 3: Connection of a storage tank for domestic hot water, of an underfloor coil and a fan coil**

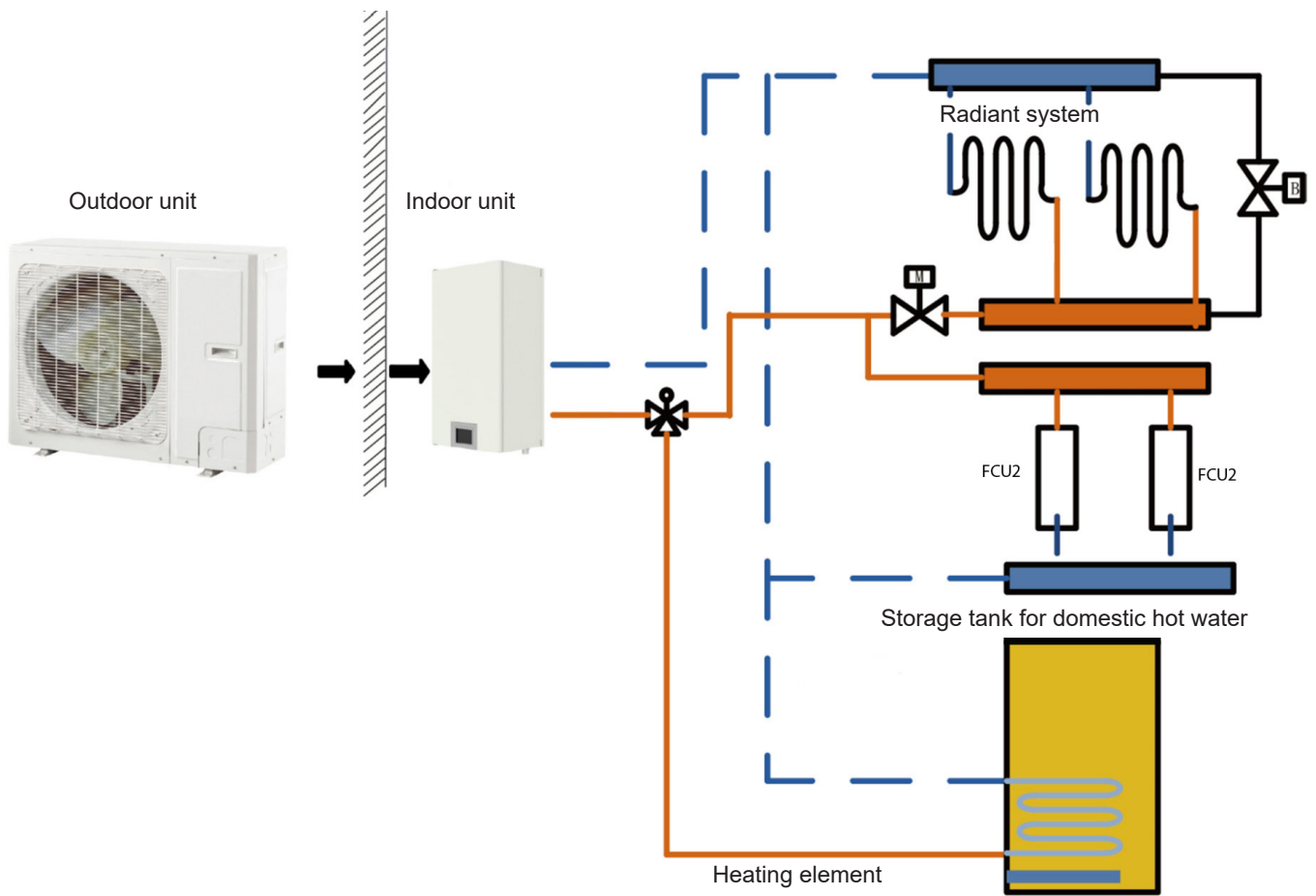

Symbol	Description
	Shut-off valve
	Remote ambient thermostat (provided on site)
	By-pass valve (provided on site)
	Three-way valve (provided on site)
	Three-way valve (provided on site)
	High-temperature line
	Low-temperature line

**Notes**

- (a) The two-way valve is key to avoid condensation on the floor and on fan coil in cooling mode.
- (b) In this case, a three-way valve must be installed according to the instructions in this manual.
- (c) The storage tank for domestic hot water should be equipped with an internal electric heater to ensure a sufficient heating power in very cold conditions.
- (d) When the fan coil and underfloor coil are used simultaneously, the underfloor coil has priority. When fan coil operation is requested, the "Floor config" parameter must be set to "Without".

## 6. Key components

### 6.1 Indoor unit

(1) PROCIDA IWU 4, PROCIDA IWU 6



Indoor unit

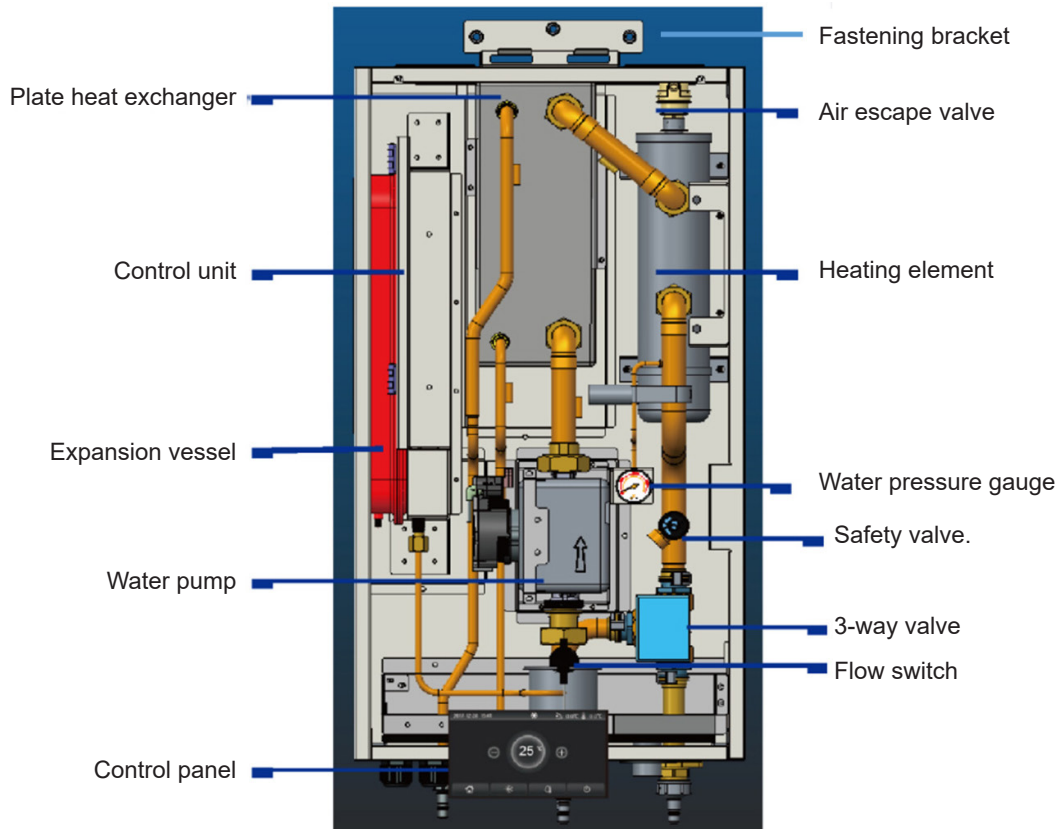

Internal view



Indoor unit

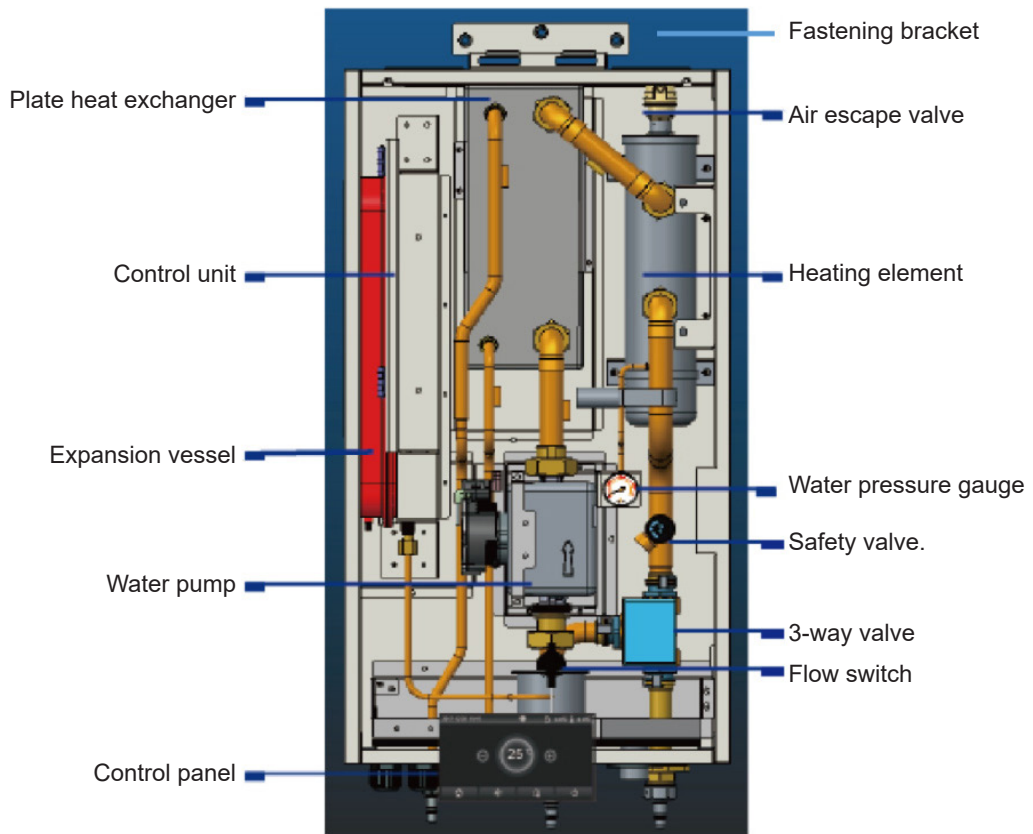

Internal view

## 6.2 Outdoor unit

(1) PROCIDA AWS 4 (O), PROCIDA AWS 6 (O)

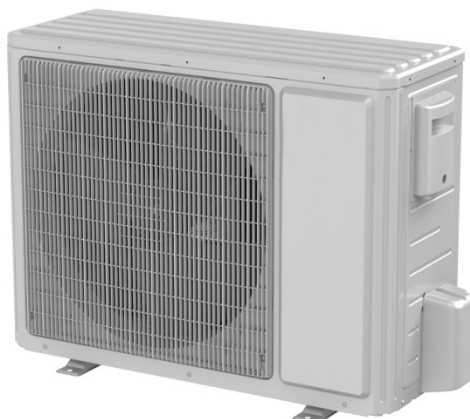

Outdoor unit

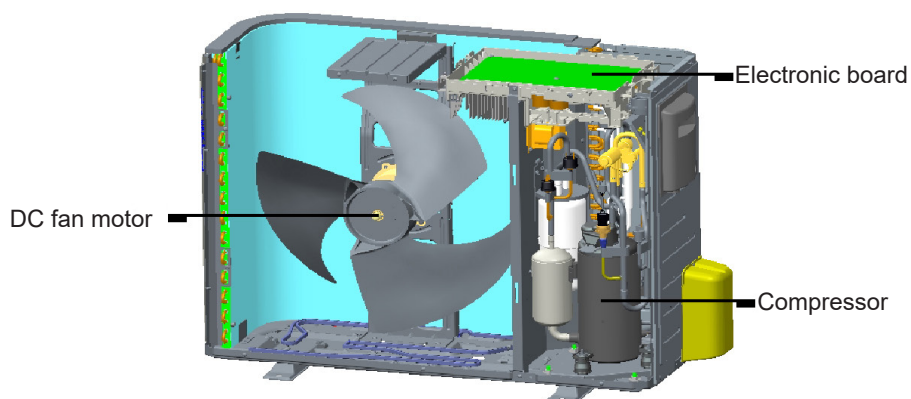

Internal view

(2) PROCIDA AWS 8 (O), PROCIDA AWS 10 (O)



Outdoor unit

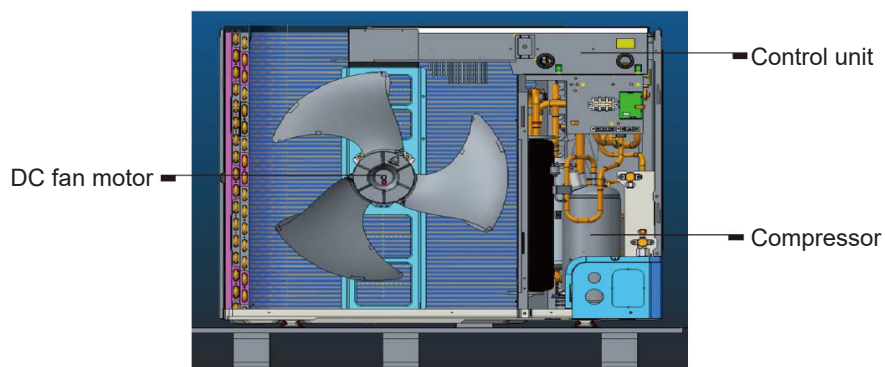

Internal view

## 7. Guidelines for outdoor unit installation

### Safety precautions when using flammable refrigerants

1. For the required qualifications of installation and maintenance personnel, see Section 7 “Installation of the Hydraulic Unit”.

All personnel working on the cooling system must hold a valid certification issued by the competent authority and an industry-recognised qualification to work on cooling systems. If maintenance and repair work requires other technicians, the latter must be supervised by the person qualified to handle flammable refrigerants.

Repairs may only be carried out as recommended by the appliance manufacturer.

2. Notes on installation

The unit may not be used in a room where there is a burning fire (fireplace, gas stove, heater).

Drilling or burning the connection pipe is not permitted.

The unit must be installed in a room that is larger than the minimum intended area. The minimum intended area of the room can be found on the identification plate or referring to the table below.

A system leak test must be carried out after installation.

Required filling load (kg)	Minimum intended room area (m <sup>2</sup> )													
	≤1,84	1,85	1,9	1,95	2	2,05	2,1	2,15	2,2	2,25	2,3	2,35	2,4	2,45
floor mounted	/	30	31	33	35	36	38	40	42	44	46	48	50	52
window installation	/	11	12	12	13	13	14	15	15	16	17	17	18	19
wall-mounting	/	5	5	5	5	5	6	6	6	6	6	6	6	6
ceiling installation	/	4	4	4	4	5	5	5	5	5	5	5	5	5

3. Notes for maintenance

Ensure that the maintenance area or room area meet the required values.

The unit can only be used in rooms meeting the required specifications.

Make sure that the maintenance area is properly ventilated.

Ventilation must be always active during system operation.

Check the maintenance area for any sources of fire.

The use of open flames is prohibited in the maintenance area; it is also recommended to post the “no smoking” sign.

Check that the warning sign attached to the unit is in good condition.

Replace any faded or damaged warning signs.

4. Welding

If it is necessary to cut or weld refrigerant system pipes during maintenance operations, proceed as follows:

- » Switch off the unit and disconnect it from the power supply
- » Remove the refrigerant
- » Create vacuum
- » Clean the system using gas N2
- » Carry out the cutting or welding operation
- » Bring the unit back to service area for welding. Recycle all refrigerant using the suitable storage tank.

Ensure that there are no open flames close to vacuum pump outlet and the area is well ventilated.

## 5. Filling with refrigerant

Use the specific filling equipment for R32 refrigerant. Avoid cross-contamination between different types of refrigerant. The refrigerant tank must be held in vertical position during filling.

After refilling (or topping up), apply the corresponding sticker on the system.

Do not overfill the system. After refilling, check for leaks before testing. The leak test should be carried out even in case of removal.

## 6. Safety instructions for transport and storage

Use a flammable gas detector before draining and opening the tank. Avoid sources of ignition and smoking.

Comply with local laws and regulations.

## 7.1 Instructions for the installation

1. Unit must be installed according to applicable national and local safety regulations.
2. Installation quality directly affects the normal operation of the air conditioner. Do not install it on your own. Contact the dealer for after-sales service. Installation and tests must be carried out by professional installers, in compliance with the installation manual.
3. Do not connect the power supply unless installation is completed.

## 7.2 Outdoor unit installation

### 7.2.1 Choosing the position for outdoor unit installation

1. The outdoor unit must be installed on a firm and solid support.
2. The outdoor unit must be installed close to the indoor unit so as to minimise the length and bends of the cooling pipe.
3. Do not set the outdoor unit under a window or between two buildings to prevent that the normal noise emission in operation may be heard in the room.
4. Do not obstruct the air inlet and outlet areas.
5. Install the unit in a well-ventilated place, so that the machine may absorb and release a sufficient quantity of air.
6. Do not install the unit in places containing flammable or explosive materials or in places exposed to dust, salt spray and polluted air.

### 7.2.2 Outdoor unit external dimensions

- (1) PROCIDA AWS 4 (O), PROCIDA AWS 6 (O)

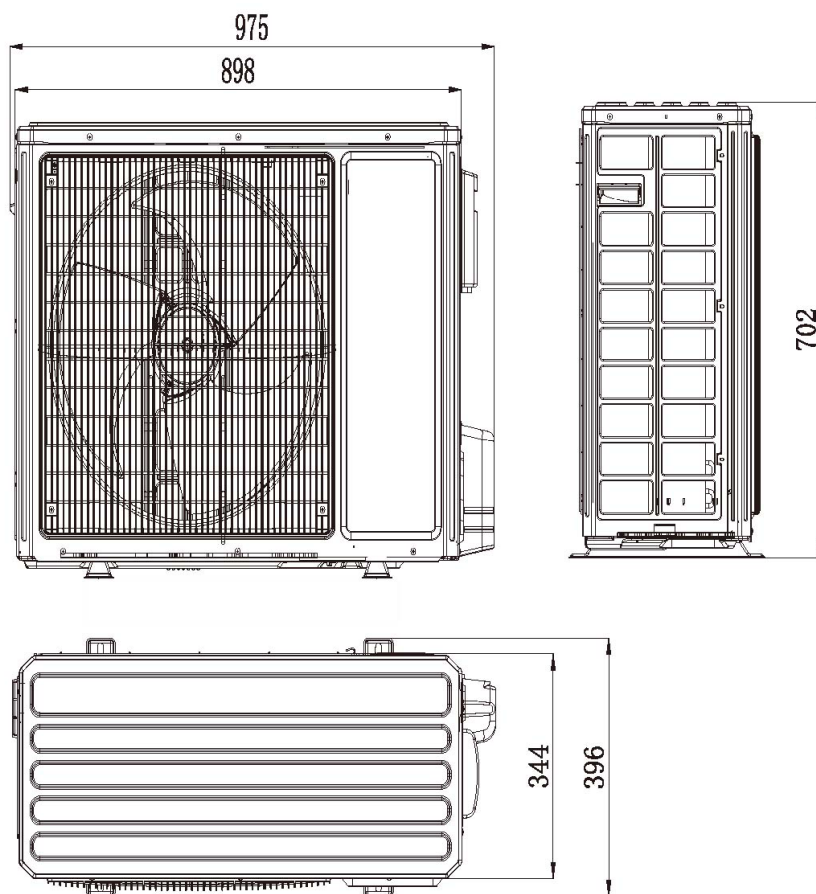



(2) PROCIDA AWS 8 (O), PROCIDA AWS 10 (O)

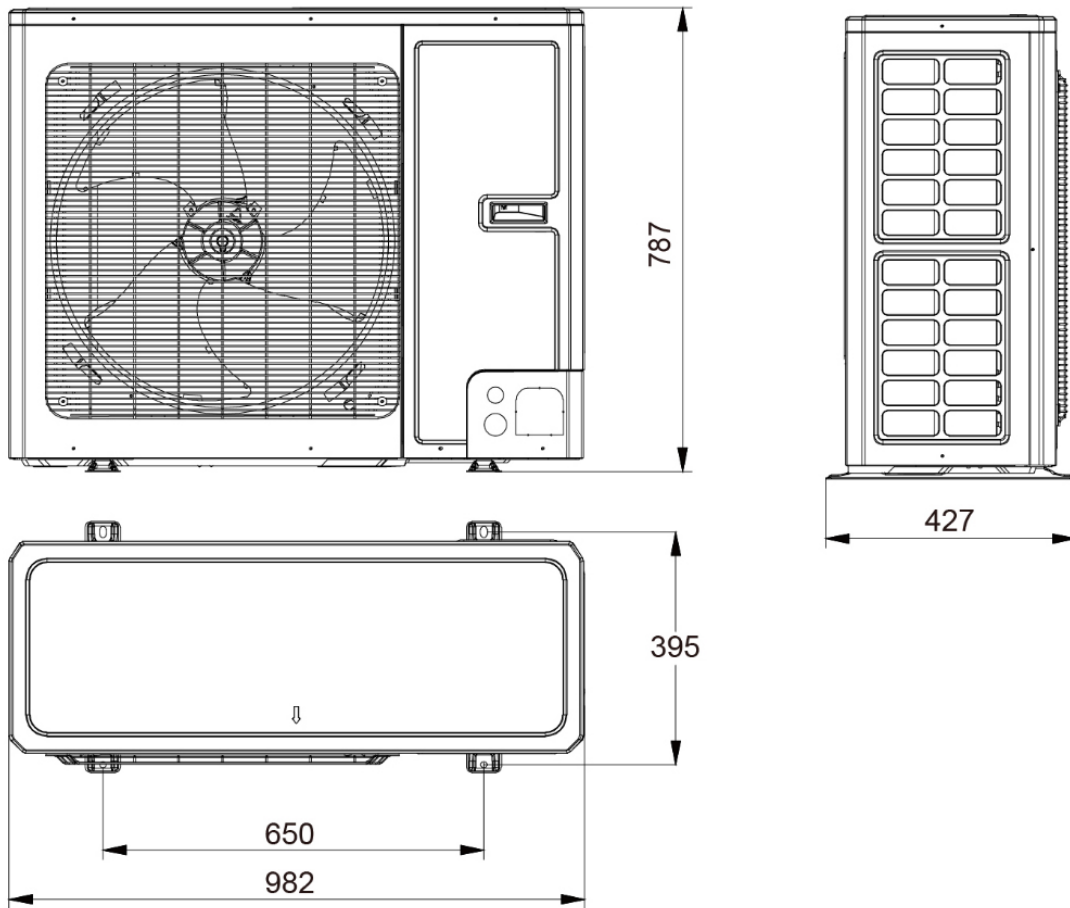

**Description**

Unit: millimetres

N.	Name		Notes
1	Service valve - liquid side	1/4	PROCIDA AWS 4 (O), PROCIDA AWS 6 (O) PROCIDA AWS 8 (O), PROCIDA AWS 10 (O)
2	Service valve - gas side	1/2	
3	Handle		Used to cover or uncover the front housing
4	Air outlet grille		/

**7.2.3 Space required for installation**

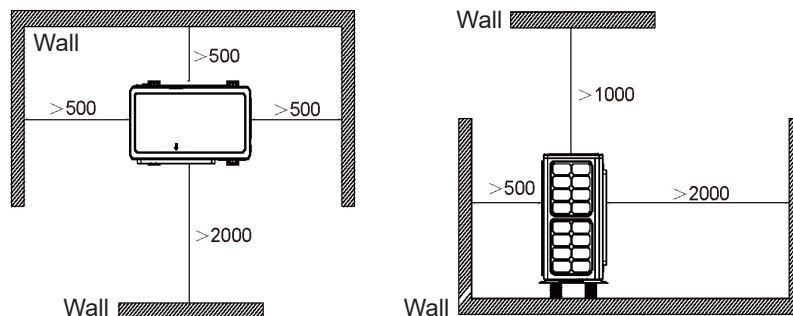

**7.2.4 Precautions for outdoor unit installation**

1. To handle the outdoor unit, it is necessary to use two ropes long enough to support the unit in all 4 directions. The angle between the ropes when unit is being lifted and handled must be below 40° so as to avoid shifting the centre of gravity of the unit.
2. Use M12 bolts to fasten the feet and the frame base during installation.
3. The outdoor unit should be installed onto a 10 cm high cement base.
4. Space requirements for unit installation are shown in the figure.
5. Lift the outdoor unit using the suitable hole. Duly protect the unit while lifting it. To avoid rust, make sure to avoid damaging the metal parts.

6. Note: support the panel with your hand when loosening and tightening the clamp screw. After connecting the power cable, use the elastic clamp to secure it to the pipe.

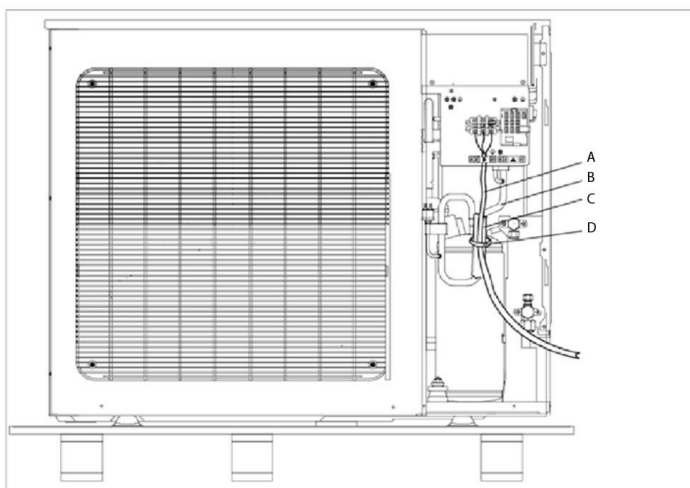
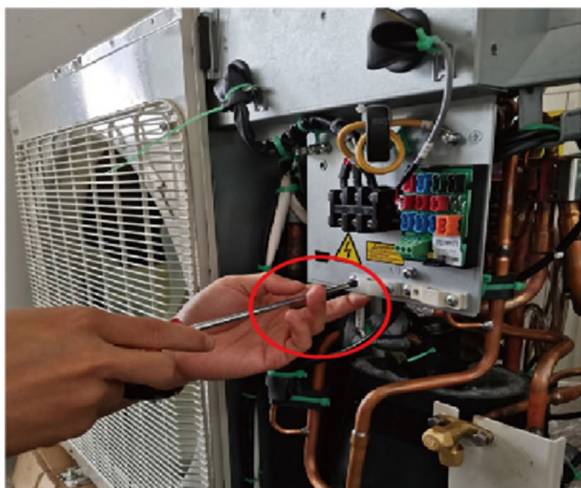

**A** = Power cable  
**B** = Pipe

**C** = Insulation  
**D** = Elastic clamp

## 8. Indoor unit installation

### 8.1 Choosing the position for indoor unit installation

- Avoid direct sunlight.
- Ensure that the suspension rod, ceiling and building structure are strong enough to support the weight of the air conditioner.
- The exhaust pipe is easy to connect.
- The connection pipes of the indoor unit and the outdoor unit are easy to connect.
- Do not install in a place where flammable or explosive goods are present or where flammable or explosive gases may escape.
- Do not install in a place exposed to corrosive gas, heavy dust, salt spray, smoke, or considerable humidity.



#### NOTE

- The indoor unit must be lifted by at least two persons. The weight of the indoor unit is more than 50 kg.
- The indoor unit must be installed perpendicular to the ground and securely fastened.
- Before commissioning, the dust cap of the automatic bleed valve must be loosened but not removed, and can be screwed on in case of leakage.

## 8.2 Clearances to be observed when installing the indoor unit (mm)

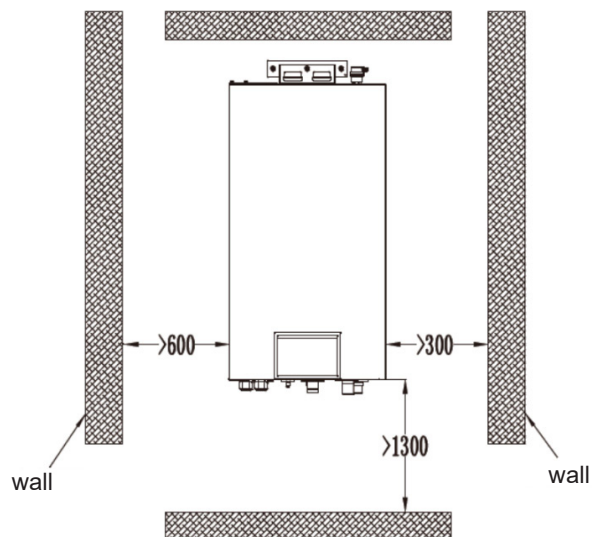

Phase 1: Drill 3 10 mm holes in the wall according to the sizes given in the drawing below.

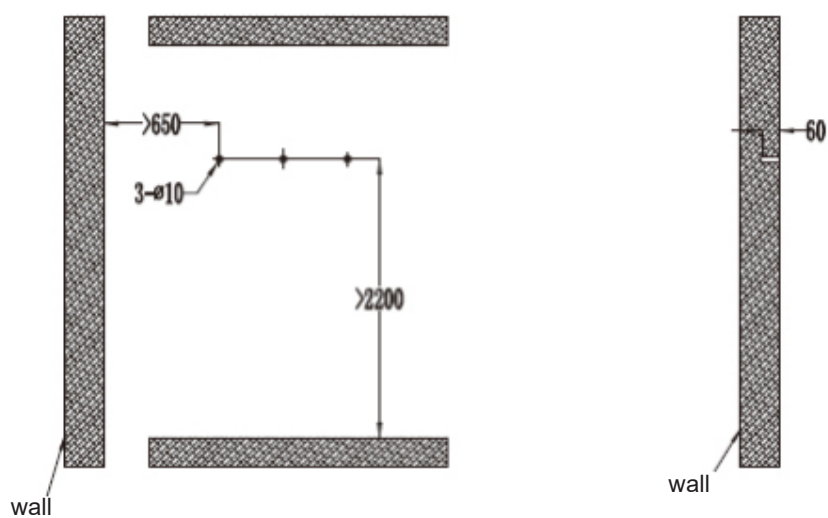

Phase 2: Insert the 3 screw anchors into the wall and fasten the bracket with the appropriate bolts

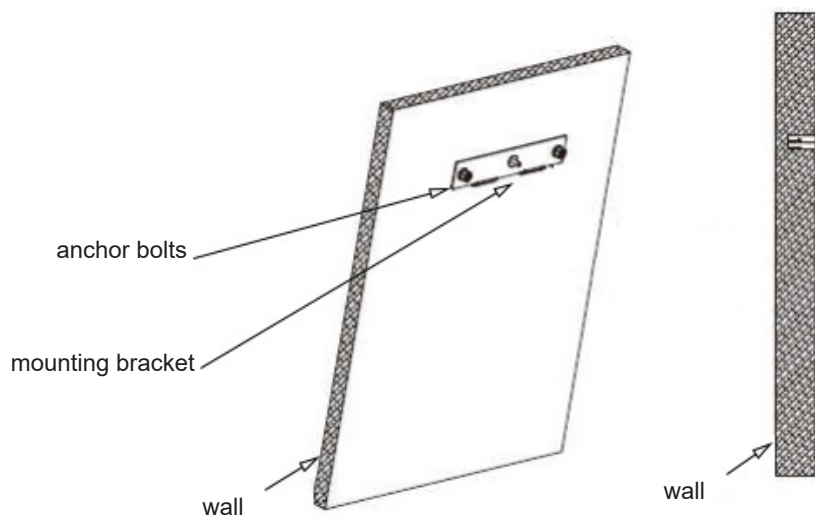

Phase 3: Install the indoor unit on the mounting bracket

### 8.3 Indoor unit external dimensions

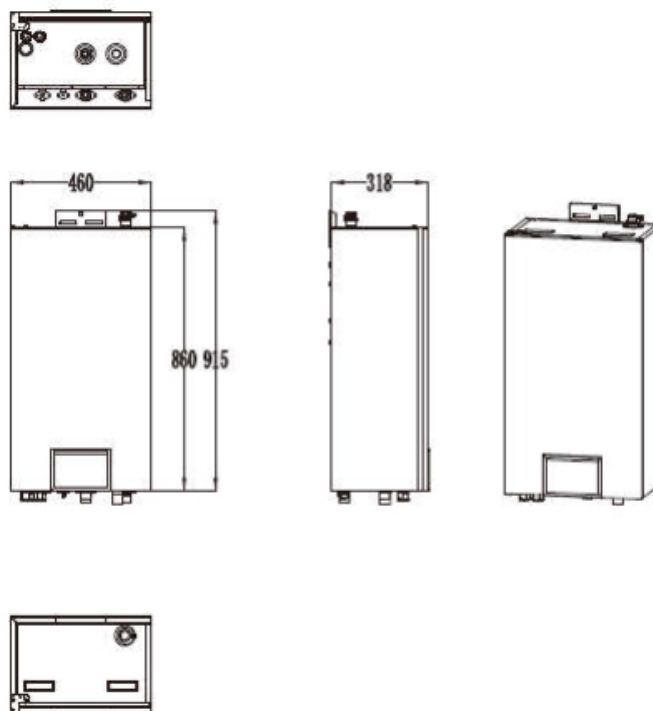

N.	Name	Notes	
1	Flow water pipe	1" BSP male	
2	Return water pipe	1" BSP male	
3	Gas side pipe	1/2	PROCIDA IWU 4, PROCIDA IWU 6
4	Liquid side pipe	1/4	PROCIDA IWU 8, PROCIDA IWU 10

### 8.4 Precautions for indoor unit installation

- The indoor unit must be mounted vertically on the wall of the room using a screw anchor.
- As far as possible, keep the indoor unit away from any heat sources in the room, such as the heat sink.
- Place the indoor unit as close as possible to the outdoor unit. The height difference between the connecting pipes can not exceed 20 m (4.0-6.0kW) or 25 m (8.0-10kW) and the vertical distance cannot exceed 15 m (4-10kW).

### 8.5 Water volume and pump capacity

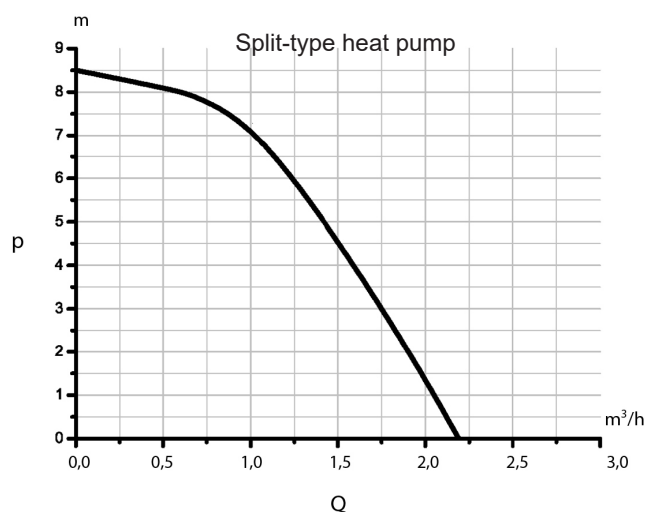

P = Static pressure at external outlet

Q = Water flow rate

#### Note

The above curve shows the maximum external static pressure. The water pump has a variable frequency. During operation, the water pump controls outlet according to actual load.

## 8.6 Water volume and pressure in the expansion tank

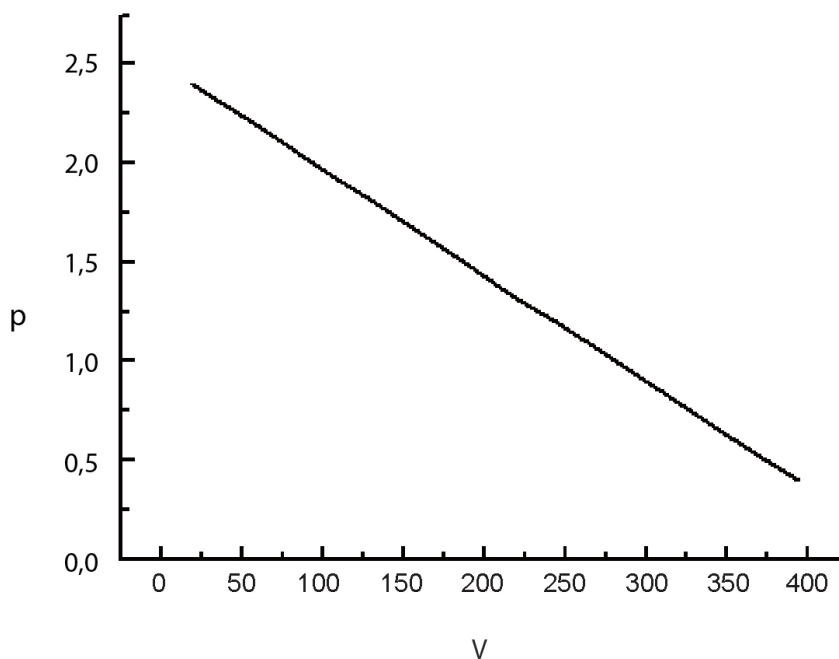

**P** = Preset pressure in the expansion tank

**V** = Total maximum water volume (litres)

### Notes

- The expansion tank has a capacity of 10 litres and is pre-pressurised to 1 bar;
- Total water volume is usually 280 litres; if the total water volume is modified because of installation conditions, the preset pressure must be adjusted accordingly, in order to ensure proper operation. If the indoor unit is installed in the top position, adjustment is not necessary;
- Total minimum water volume is 20 litres;
- To adjust preset pressure, use nitrogen gas provided by a certified installer.

## 8.7 Selecting the expansion tank

Formula

$$v = \frac{c \cdot e}{1 - \frac{1 + p_1}{1 + p_2}}$$

- **V**--- Expansion tank volume
- **C**--- Total water volume
- **P<sub>1</sub>**--- Preset pressure of the expansion tank
- **P<sub>2</sub>**--- Highest pressure reached during system operation (corresponding to the safety valve trigger pressure).
- **e**--- Water expansion coefficient (difference between expansion coefficient of water original temperature and the one of maximum water temperature).

Water expansion coefficient at different temperatures	
Temperature (°C)	Expansion coefficient e
0	0,00013
4	0
10	0,00027
20	0,00177
30	0,00435
40	0,00782
45	0,0099
50	0,0121
55	0,0145
60	0,0171

Water expansion coefficient at different temperatures	
65	0,0198
70	0,0227
75	0,0258
80	0,029
85	0,0324
90	0,0359
95	0,0396
100	0,0434

## 9. Piping connection

### 9.1 Connecting the outlet pipe for indoor unit and outdoor unit

1. Align the copper pipe taper end with the centre of the threaded joint. Tighten the flare nuts by hand.
2. Tighten the flare nuts using the torque wrench until hearing it click.
3. Connection pipe bend must not be too narrow or pipe may break. Use a pipe bender to bend the pipe.
4. When connecting the outdoor unit and the indoor unit, do not pull small and big joints of the indoor unit; failure to do so may create cracks of the indoor unit resulting in leaks.
5. The connecting pipe must be supported by a bracket so as to avoid that other units bear its weight.

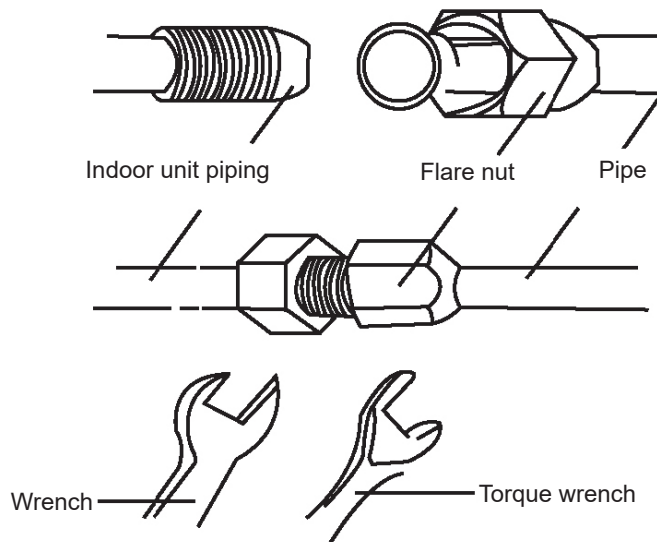

### 9.2 Applying a protection layer to the connecting pipe

- Gas and liquid pipes must be wrapped into insulating material and adhesive tape to ensure they are insulated from the environment. This will avoid water leakage from or condensation on the connecting pipe.
- Wrap indoor unit and outdoor unit joints into insulating material taking care to fully cover the section between pipe and unit wall.
- Wrap the pipe with tape.
  - » Use adhesive tape to wrap the connecting pipe and cable in a single bundle. To ensure that condensate will not come out of drain pipe, the pipe must be separated from connecting pipe and cable.
  - » Wrap in heat insulating tape so that every piece of tape overlaps the previous one by half.
  - » Take the wrapped pipe and fasten it to the wall using a clamp.
  - » If you wrap the pipe too tight, the heat insulation will decrease.
  - » After completing the protection and properly wrapping the pipe, fill the holes on the wall with sealing materials.

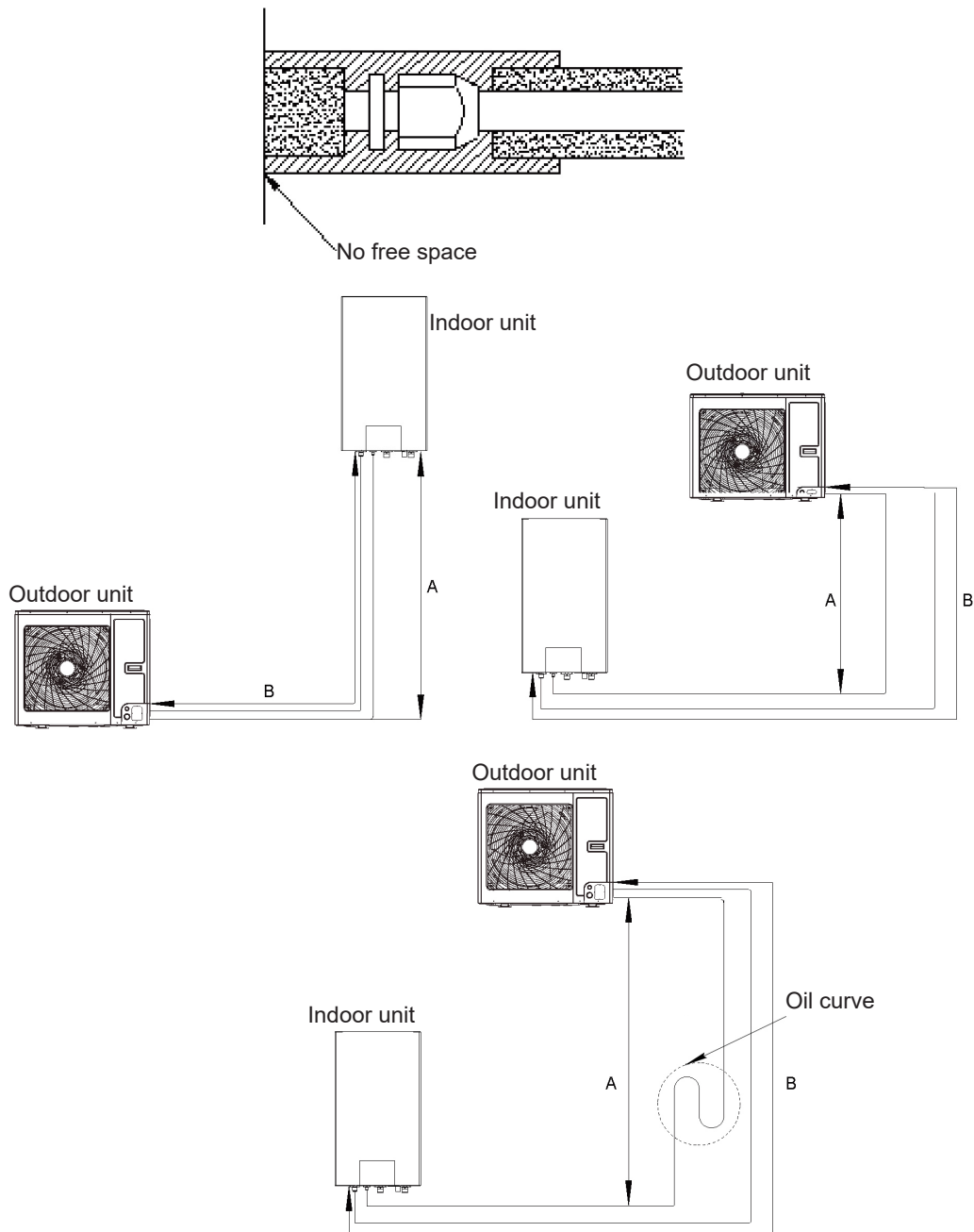

Model	Pipe size (Diameter: $\Phi$ )		Length B		Height A		Additional refrigerant
	Gas	Liquid	Standard	Max.	Standard	Max.	
PROCIDA AWS X4	1/2"	1/4"	5m	20m	0m	15m	16g/m
PROCIDA AWS X6	1/2"	1/4"	5m	20m	0m	15m	16g/m
PROCIDA AWS X8	1/2"	1/4"	5m	25m	0m	15m	16g/m
PROCIDA AWS X10	1/2"	1/4"	5m	25m	0m	15m	16g/m

**Notes**

- No additional refrigerant is required when pipe length is less than 10 m. If pipe is longer than 10 m, additional refrigerant is required according to the table.
- For instance: if the 10 kW model is installed at a distance of 25 m, it is necessary to add  $(25-10) \times 16 = 240$  g of refrigerant. The nominal capacity is based on standard pipe length and maximum allowed length is based on product operating reliability. When outdoor unit is higher than indoor unit, an oil trap must be installed every 5-7 metres.

## 10. Remote ambient temperature sensor



Front side

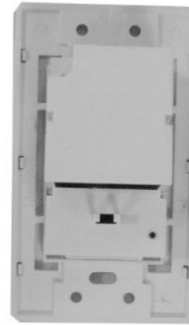

Rear side

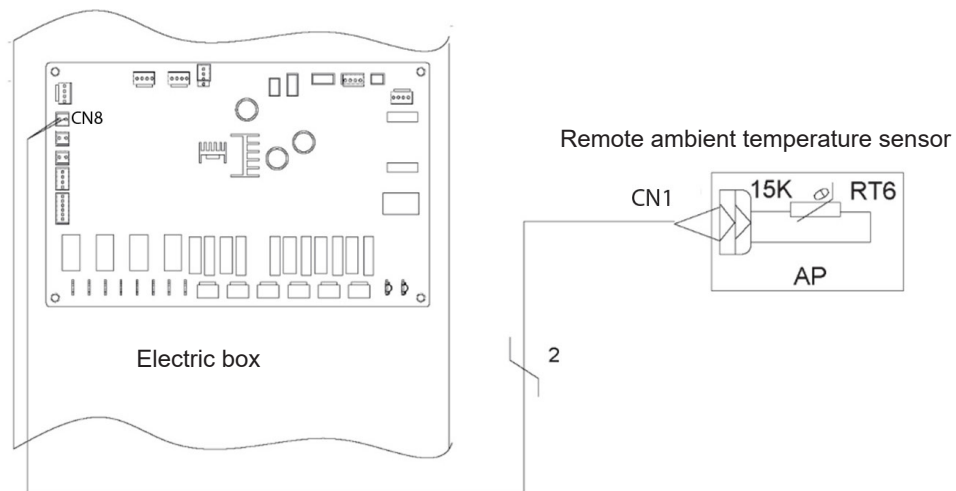
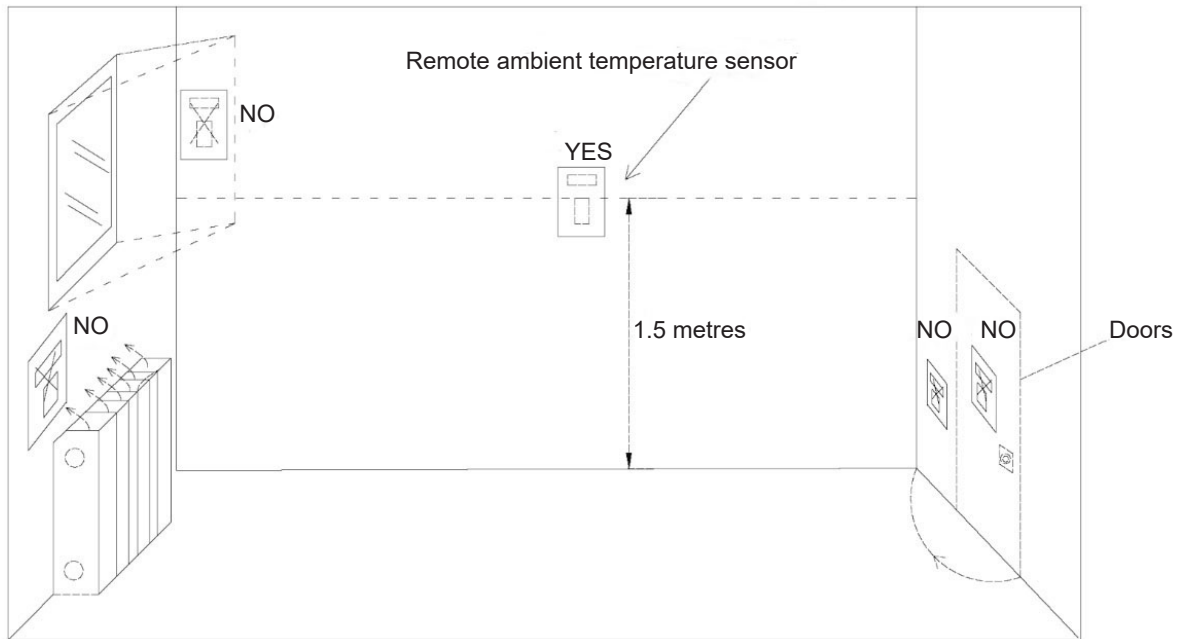

### Notes

- The distance between the indoor unit and the remote ambient temperature sensor must be lower than 15 m, because of the length of the remote sensor connection cable;
- Height above floor is approximately 1.5 m;
- The remote ambient temperature sensor must not be installed in a position where it could be hidden when door is open;



- The remote ambient temperature sensor must not be installed in a position where it would be affected by external heat;
- The remote ambient temperature sensor must be installed in a position where ambient heating is normally installed;
- After installing the remote ambient temperature sensor, it is recommended to set the corresponding option to "With" using the wired control so as to adjust ambient temperature at the control point.

## 11. Thermostat

Thermostat installation procedure is similar to the one for the remote ambient temperature sensor.

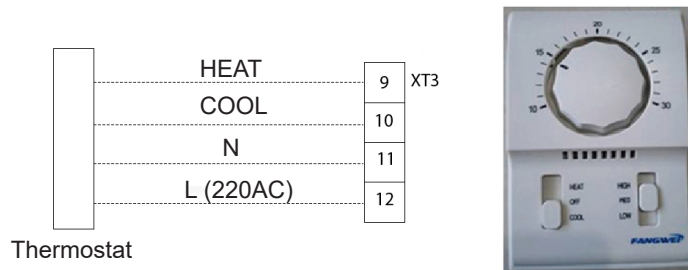

### Thermostat connection

1. Remove the indoor unit front cover and open the electric box;
2. Identify thermostat power specifications: if it is 220 V, identify terminal board XT3 as NO.9~12;
3. If it is a heating/cooling thermostat, connect the wires as shown in the above figure.



### NOTE

- Thermostat 220 V power supply can be provided by the heat pump.
- The temperature set using the thermostat (heating or cooling) must fall in the range specified for the product;
- For other constraints, refer to the previous pages on remote ambient temperature sensor;
- Do not connect any external electrical loads. The 220 VAC cable must only be used for the electrical thermostat;
- Do not connect any external electrical loads such as valves, fan coils, etc. Connecting these parts could seriously damage the main board of the unit;
- Thermostat installation procedure is similar to the one for the remote ambient temperature sensor.

## 12. 2-way valve

The two-way valve 1 controls water flow rate in the underfloor circuit. If the "Floor Config" parameter is set to "With" for the cooling or heating function, the valve is kept open. If the "Floor Config" parameter is set to "Without", the valve is kept closed.

### General

Type	Power supply	Operating mode	Supported
NO 2 wires	230 V 50 Hz ~AC	Close water flow	yes
		Open water flow	yes
NC 2 wires	230 V 50 Hz ~AC	Close water flow	yes
		Open water flow	yes

1. NO type (normally open). The valve is open when NO current is applied. (The valve closes when current is applied).
2. NC type (normally closed). The valve is closed when NO current is applied. (The valve opens when current is applied).
3. Connecting a two-way valve:

Electrically connect the two-way valve as follows.

- Phase 1. Remove the unit front cover and open the electric box.
- Phase 2. Identify the terminal board and connect the wires as shown below.

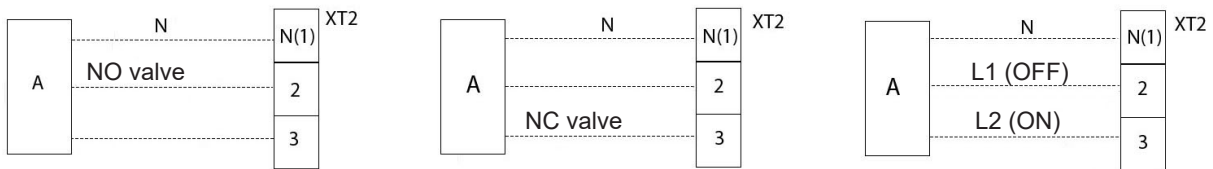

A = 2-way valve 1



### WARNING

- The NO valve (normally open) must be connected to wire (OFF) and to wire (N) to obtain that it closes in cooling mode.
- The NC valve (normally closed) must be connected to wire (ON) and to wire (N) to obtain that it closes in cooling mode.
- (ON): Line signal (for NO type) from PCB to 2-way valve
- (OFF): Line signal (for NC type) from PCB to 2-way valve
- (N): Neutral signal from PCB to 2-way valve

## 13. 3-way valve

The three-way valve 2 is required for domestic hot water storage tank. It switches between the underfloor heating circuit and the storage tank heating circuit.

General

Type	Power supply	Operating mode	Supported
SPDT 3 wires	230 V 50 Hz ~AC	Selecting "Flow A" between "Flow A" and "Flow B"	yes
		Selecting "Flow B" between "Flow B" and "Flow A"	yes

1. SPDT = single pole double throw The three wires correspond to Phase1 (for selecting Flow B) and to neutral (common).
2. Flow A is the "water flow from the indoor unit to the underfloor water circuit".
3. Flow B is the "water flow from the indoor unit to the storage tank for domestic hot water".

Electrically connect the three-way valve as follows.

Follow Phase 1 and Phase 2 of the procedure below.

- Phase 1. Remove the unit front cover and open the electric box.
- Phase 2. Identify the terminal board and connect the wires as shown below.

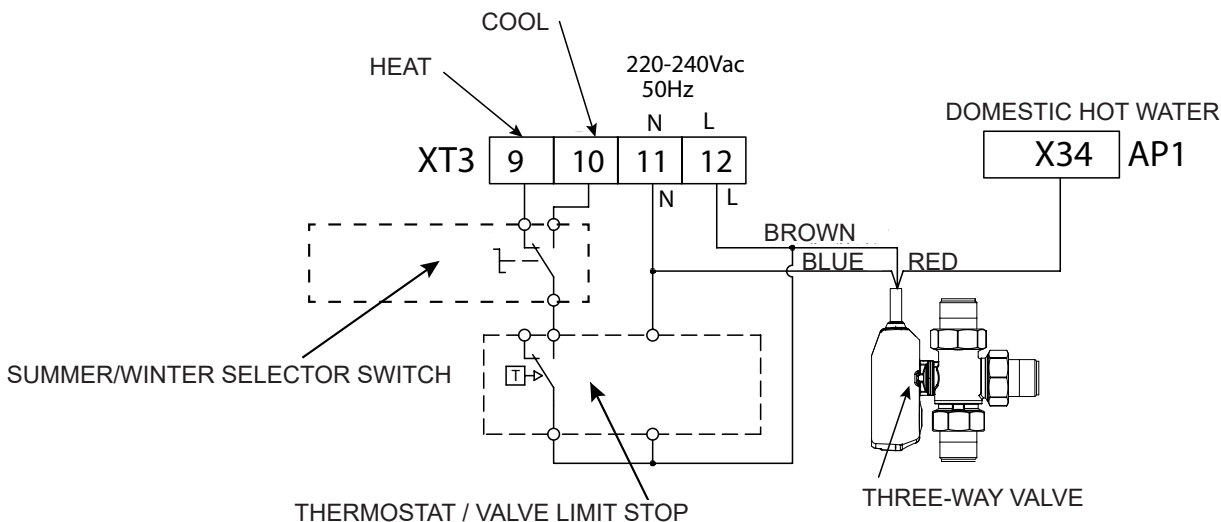

### WARNING

- The three-way valve selects the storage tank circuit when terminal X34 is powered.
- The three-way valve selects the heating circuit when terminal X34 is not powered.
- The valve must be permanently powered at terminals 11-12.

## 14. Other auxiliary heat sources

The appliance allows the connection of an auxiliary thermal unit, which can be controlled so that the main board delivers 230 V when the outside temperature is lower than the set value for activating the auxiliary heat source.

Note: It is NOT possible to install an auxiliary thermal unit together with an optional electric heater.

### Phase 1. Installation of an auxiliary thermal unit

The auxiliary thermal unit must be installed in parallel to the monobloc unit. Moreover, an optional sensor must be installed for water temperature (5 metre long), available as an accessory.

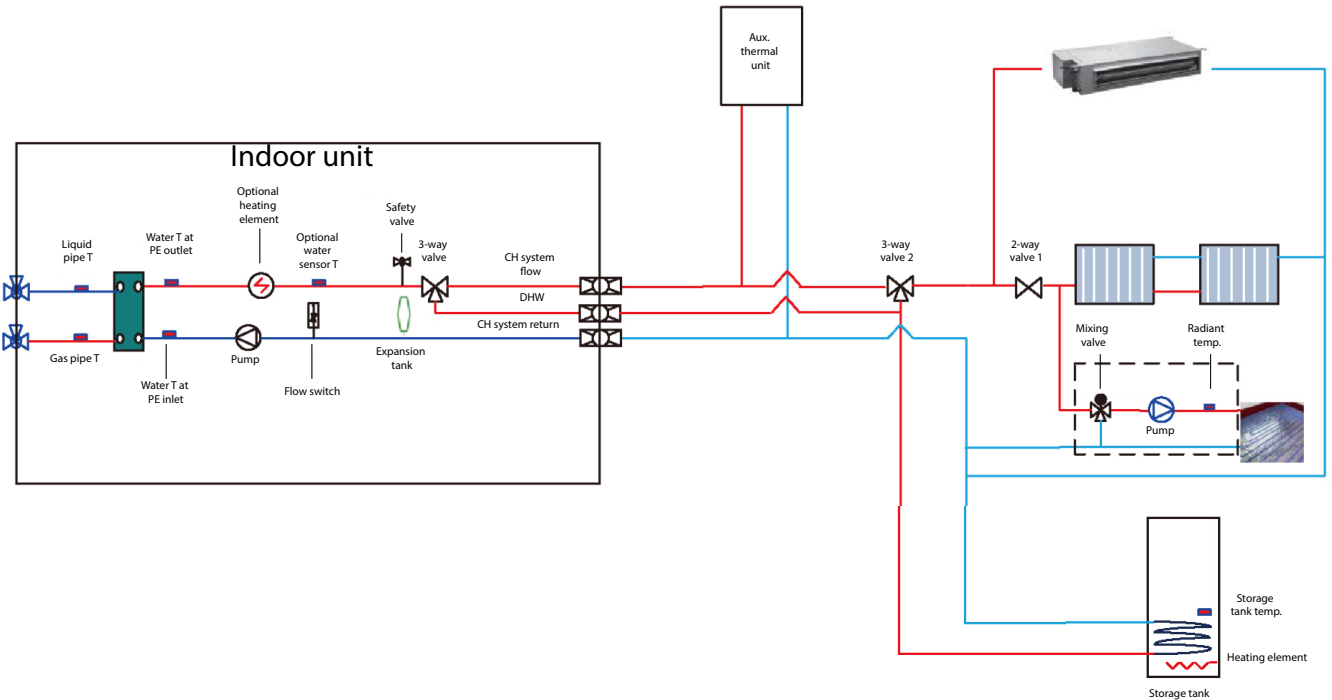

### Phase 2. Electrical connection

Connect L and N wires of the auxiliary thermal unit to XT2~3,4.

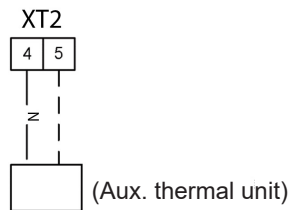

### Phase 3. Setting the wired control

If necessary, select "With" for "Other thermal" parameter within COMMISSION → FUNCTION, then set (outdoor) temperature switch and control logic (1/2/3)

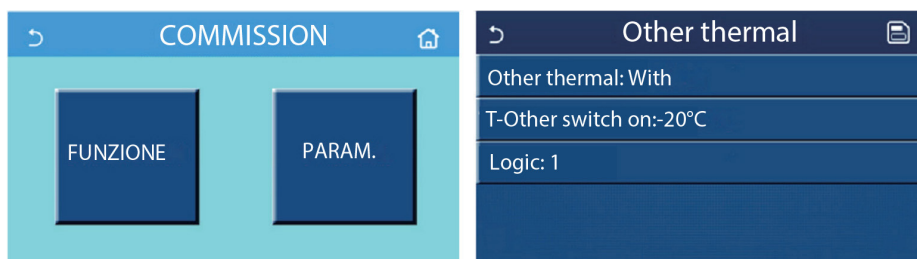

## 15. Door control unit

If a door control function is available, install as follows:

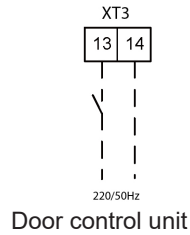

## 16. Refrigerant filling and draining

1. The outdoor unit is filled with refrigerant by the manufacturer before shipment. Refrigerant may be topped up when connecting the piping on site.
2. Check gas and liquid valves of the outdoor unit. Valves must be fully closed.
3. Connect a vacuum pump to outdoor unit liquid valve and gas valve to bleed air from the indoor unit and connecting pipe. Refer to the figure below:

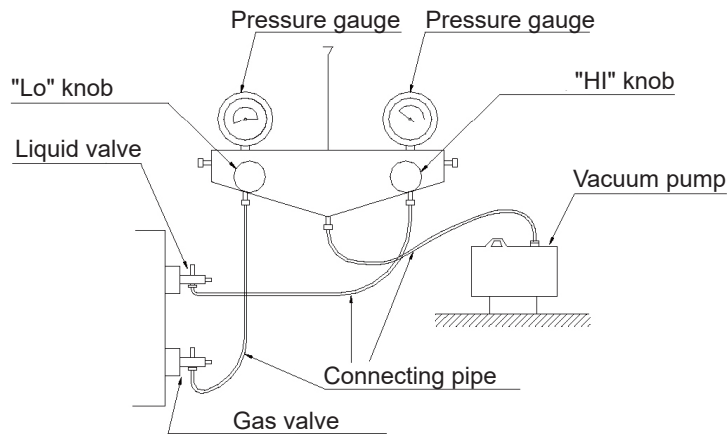

4. After making sure that system is free of leaks, with compressor off, fill the specified additional quantity of R32 into the unit through the filler opening on liquid pipe valve of the outdoor unit.
  - » Make sure to fill the specified quantity of liquid refrigerant into the liquid pipe. Considering that this refrigerant is mixed, adding it as a gas could change its composition and compromise normal operation.
  - » Before filling, check whether the refrigerant cylinder is equipped with trap.

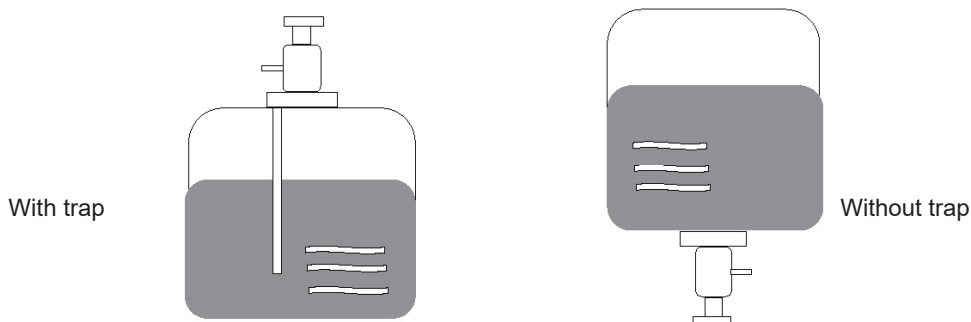

### WARNING

When filling is interrupted or as soon as it is completed, inspect the unit again without starting the compressor.



### NOTE

Do not use a mix of refrigerant vapour and air or oxygen to pressurise because there is a risk of explosion.

## 17. Collecting refrigerant

To transfer or dispose of the outdoor/indoor units, drain the system according to the procedure below, so that the refrigerant is not released into the atmosphere.

1. Switch power supply off (circuit breaker).
2. Connect the low pressure valve on the pressure gauge manifold to the filler plug (low pressure side) of the outdoor unit.
3. Completely close the liquid stop valve.
4. Power supply (circuit breaker). Starting communication between indoor and outdoor systems takes approximately 3 minutes from switch-on (circuit breaker). Start the draining procedure 3-4 minutes after switch-on (circuit breaker).
5. Collect the refrigerant. Within commissioning parameters setting page, touch "Refri. recovery" to open the corresponding settings.

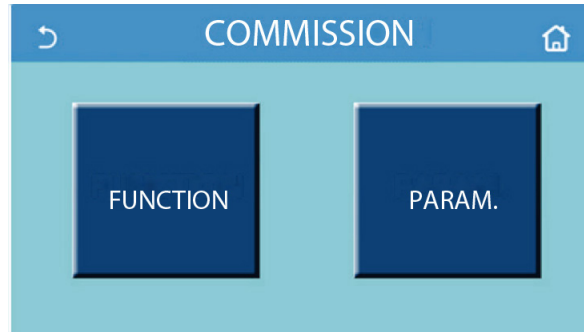

6. Completely close the ball valve on outdoor unit gas pipe side when manifold pressure gauge reads a value ranging from 0.05 to 0 MPa [Gauge] (approx. 0.5 to 0 kgf/cm<sup>2</sup>) and quickly stop the air conditioner. If "Refri. recovery" parameter is set to "On", the control panel goes back to the home page. At that point, touch controls will not be implemented (unless ON/OFF controls) and a dialogue box will show message "The refrigerant recovery is running!". Touch ON/OFF to stop the refrigerant recovery.
7. Disconnect the power supply (circuit breaker), remove manifold and disconnect refrigerant pipes.



### WARNING

- While draining refrigerant, stop the compressor before disconnecting refrigerant pipes.
- If refrigerant pipes are disconnected while compressor is on and stop valve (ball valve) is open, cooling circuit pressure might become very high in case of air leak, and lead pipes to burst, cause personal injury, etc.

## 18. Unit handling

- When installing or handling the unit, avoid ingress of any other substance than refrigerant in the piping and bleed any residual air.
- The presence of other substances or air in the piping increases system pressure, which may result in compressor damage.
- Do not fill the unit with any other type of refrigerant during installation or handling. This may cause inefficient operation or malfunction, mechanical faults or serious injury.
- If refrigerant must be recovered during unit handling or maintenance, a pressure gauge is required. Set the unit to cooling mode and completely close the valve on high pressure side (liquid valve). When pressure gauge reading is 0–0.05 MPa (approx. 30 s–40 s), completely close the high pressure side valve (gas valve), switch unit off and disconnect the power supply.
- If refrigerant recovery time is too long, air may enter the system. In this case, system pressure would increase and compressor would get damaged.
- When recovering refrigerant, make sure that liquid valve and gas valve are fully closed and that power supply is turned off before disconnecting the connecting pipe.

- If the connecting pipe is disconnected when compressor is still operating, air may enter the system. In this case, system pressure would increase and compressor would get damaged.
- When installing the unit, make sure that the connecting pipe is properly installed before starting the compressor.
- If compressor is started before completing connection and with shut-off valve open, air may enter the system. In this case, system pressure would increase and compressor would get damaged.
- The indoor unit and outdoor unit must be properly connected using the provided cable. The wiring terminal must be properly secured and must not be exposed to direct external forces.
- There is a risk of fire if cable is not properly connected or terminal not securely fastened.
- Cable size can not be changed. Cable can not be reconnected at the centre.
- If connecting cable length is not sufficient, contact the service centre to obtain a suitable cable having a sufficient length.

## 19. Installing a sealed storage tank

### 19.1 Installation sizes

The sealed water storage tank must be installed and held horizontally within 5 m and vertically within 3 m from the indoor unit. It can be installed in the room.

The storage tank must be installed vertically, with the support base resting on the floor and never suspended. The installation base must be sturdy enough and the storage tank must be bolted to the wall to avoid vibration, as shown in the figure below. During installation, also consider storage tank capacity.

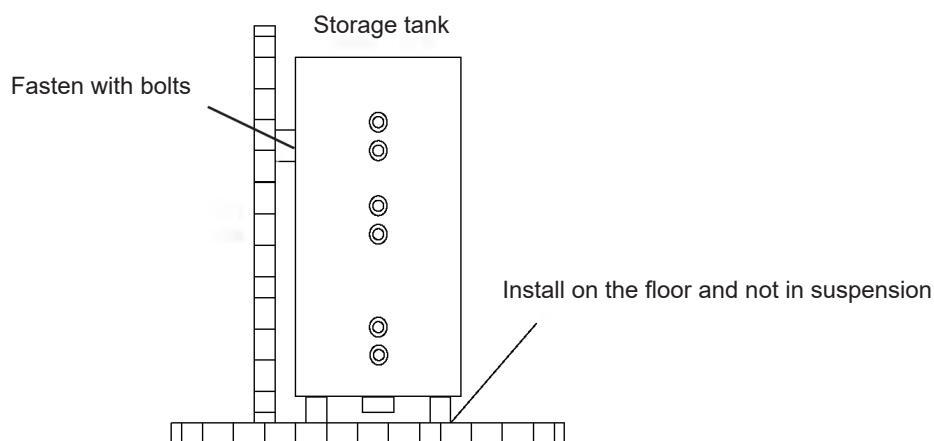

The minimum distance between the water storage tank and the combustible surface must be 500 mm.

Water pipe, hot water fitting and a floor drain must be close to the storage tank in order to make it easier to fill water, deliver hot water and drain the storage tank.

Connecting the inlet/outlet ducts: connect unit safety valve (with the arrow facing the storage tank) at storage tank inlet using the PPR pipe, as shown in the figure below, and seal using non-sintered tape. The other end of the safety valve must be connected to drinking water fitting. Connect hot water pipe and storage tank outlet using the PPR pipe.

Install a device for protecting the system against maximum pressure.

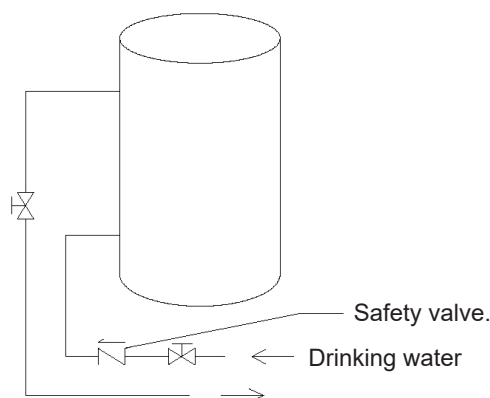

## Note

- For water safe use, it is recommended to connect the storage tank outlet and/or inlet using a certain PPR pipe length,  $L \geq 70 \times R^2$  (in cm, where R is pipe inside radius). Moreover, to preserve heat, metal pipes should be avoided. Upon first use, fill the storage tank before switching the unit on.

As the pressure in the water heater gradually increases during the heating phase, a pressure relief valve must be installed. If this is not installed or is installed incorrectly, the water heater could become deformed or damaged and harm or cause damage to people, animals and/or property.

## 19.2 Connection of the hydraulic system

- If the connection between the water storage tank and the indoor unit must pass through a wall, drill a  $\phi 70$  hole for the circulating water pipe. If a hole is not required, this step is not necessary.
- Piping preparation: the circulating water inlet/outlet pipes must be suitable for hot water.
- Installation of inlet/outlet pipes for circulating water: connect the water inlet of the unit with the outlet of the storage tank for circulating water, and connect the water outlet of the unit with the inlet of the storage tank for circulating water.
- Installation of the storage tank inlet/outlet pipes: a safety valve, filter and shut-off valve must be installed for the water inlet pipe in accordance with the installation diagram of the unit. At least one shut-off valve is required for the water outlet pipe.
- Installation of drain pipes at the base of the storage tank: connect a length of PPR pipe with drain outlet to the floor drain opening. A shut-off valve must be installed in the middle of the drain pipe, at a point where it can be easily operated by users.
- After connecting the water lines, first carry out a leak test to ensure that there are no leaks. Next, join the water pipes, water temperature sensor and electrical wires using the cable ties supplied with the unit.

## Notes

- Water lines may only be installed after the water heating unit has been secured in place. Avoid ingress of dust and other foreign particles into the pipe system when installing the connecting pipes.
- After connecting the water lines, first carry out a leak test to ensure that there are no leaks. Next, proceed with the thermal insulation of the hydraulic system, paying particular attention to the valves and fittings. The insulation tape must be sufficiently thick. If necessary, install a pipe heating device to prevent possible frost damage.
- The hot water delivered from the insulated storage tank depends on the pressure of the water tap, so there must be a running water supply.
- During use, the cooling water inlet shut-off valve of the storage tank must remain normally open.

## 19.3 Electrical connection

### 19.3.1 Connecting principle

#### General principles

- The wires, equipment and connectors provided for use on site must comply with regulations and design technical requirements.
- On site electrical connections can only be performed by qualified electricians.
- Disconnect the system from the mains before starting any connection.
- The installer will be liable for any loss or damage resulting from incorrect connection of the external circuit.
- Only copper wires are allowed.
- Connecting the power cable to the unit electrical panel
- Power cables must be laid in chases, tubes or cableways.
- The power cables to be connected to the electric cabinet must be protected with rubber or plastic parts to prevent any scratching from metal sheet edges.
- The power cables close to the unit electric cabinet must be securely fastened to prevent the cabinet power terminal from undergoing any strains.
- The power cable must be reliably connected to ground.

### 19.3.2 Power cable and residual current circuit breaker specifications

The table below gives all recommended specifications for power cables and residual current circuit breakers.

Model	Power supply	Residual current circuit breaker	Min.cross-section of ground cable	Min.cross-section of power cable
	V, Ph, Hz	(A)	(mm <sup>2</sup> )	(mm <sup>2</sup> )
PROCIDA AWS 4 (O) outdoor unit	230V,~,50Hz	16	1,5	1,5
PROCIDA AWS 6 (O) outdoor unit		16	1,5	1,5
PROCIDA IWU 4 indoor unit		20	6,0	6,0
PROCIDA IWU 6 indoor unit		20	6,0	6,0
PROCIDA AWS 8 (O) outdoor unit	230V,~,50Hz	25	4,0	4,0
PROCIDA AWS 10 (O) outdoor unit		25	4,0	4,0
PROCIDA IWU 8 indoor unit		40	6,0	6,0
PROCIDA IWU 10 indoor unit		40	6,0	6,0

#### Notes

- The residual current circuit breaker is required for additional installations. When using circuit breakers with leakage current protection, the response time must be less than 0.1 seconds and the protection circuit must be 30 mA.
- The above diameters for the power cables have been determined on the assumption that the distance between the distribution cabinet and the unit is less than 75 m. If the cables are between 75 and 150 m apart, the diameter of the power cable must be increased by one degree.
- The power supply must have the same rated voltage as the unit and use a special power line for the air conditioner.
- All electrical installations must be carried out by professional technicians, in compliance with local regulations and laws.
- Ensure that the grounding is reliable; the ground wire must be connected to the protection devices of the building and must be installed by professional technicians.
- The circuit breaker and power cable specifications in the table above are determined according to the maximum power (maximum amperes) of the unit.
- The power cable specifications in the above table refer to a multi-wire copper cable protected by a cableway (insulated copper cable type YJV) used at 40 °C and resistant up to 90 °C (see IEC 60364-5-52). If the conditions of use change, the wiring must be modified according to the applicable national regulations.
- The specifications for the circuit breaker in the above table refer to a circuit breaker with operating temperature of 40 °C. If the operating conditions change, the circuit breaker must be modified according to the applicable national regulations.
- A circuit breaker must be added to the fixed line. The circuit breaker must be omnipolar with at least 3 mm gap between contacts.



20.

Wiring diagram

20.1 Control board (Indoor unit)

(1) PROCIDA IWU 4, PROCIDA IWU 6

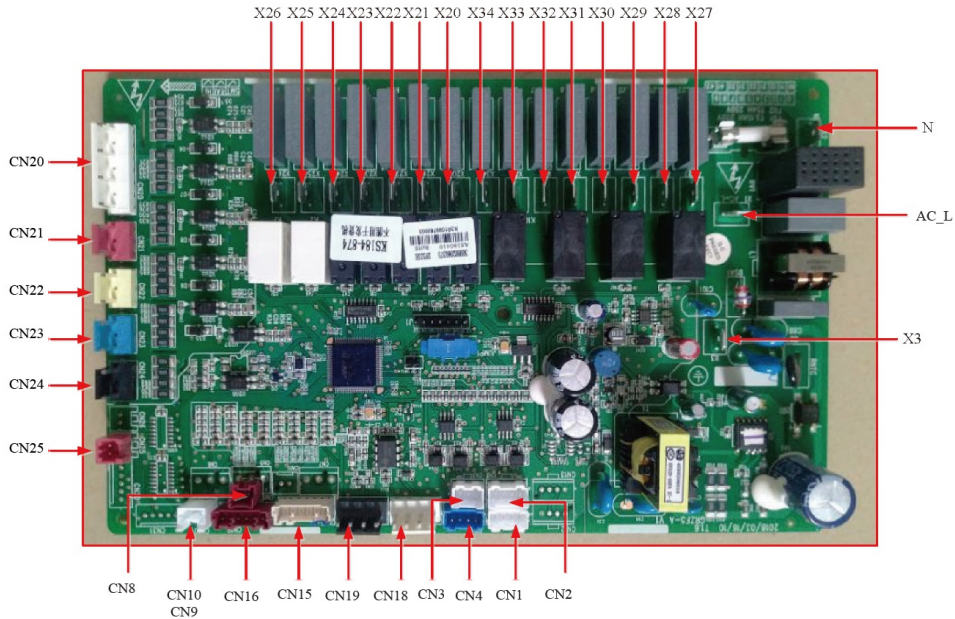

Code	Description
AC-L	Phase wire of power cable
N	Neutral wire of power cable
X3	Ground
X20	Storage tank electric heater
X21	Electric heater 1
X22	Electric heater 2
X23	Other 220VAC temperature sensor
X24	Reserved
X25	Reserved
X26	Reserved
X27	The two-way valve 1 is normally open
X28	The two-way valve 1 is normally closed
X29	Reserved
X30	Reserved
X31	Reserved
X32	Reserved
X33	Reserved
X34	3-way valve signal
CN18	Built-in water pump signal (PWM)
CN19	Aux. water pump signal (PWM) - provided on site
CN15	Temperature sensor 20 K (inlet water)
CN15	Temperature sensor 20 K (outlet water)
CN15	Temperature sensor 20 K (refrigerant liquid line)

Code	Description
CN16	Temperature sensor 10 K (outlet water for optional electric heater)
CN16	Reserved
CN10	Storage tank temperature sensor
CN9	Remote ambient temperature sensor
CN7	Reserved
CN6	Reserved
CN5	Reserved
CN20	Thermostat
CN21	Detection of welding protection for optional electric heater 1
CN22	Detection of welding protection for optional electric heater 2
CN23	Detection of welding protection for storage tank electric heater
CN24	Access detection
CN25	Flow switch
CN26	Reserved
CN3	Communication with outdoor unit
CN4	Communication with control panel

(2) Board for Outdoor unit PROCIDA AWS 4 (O), PROCIDA AWS 6 (O)

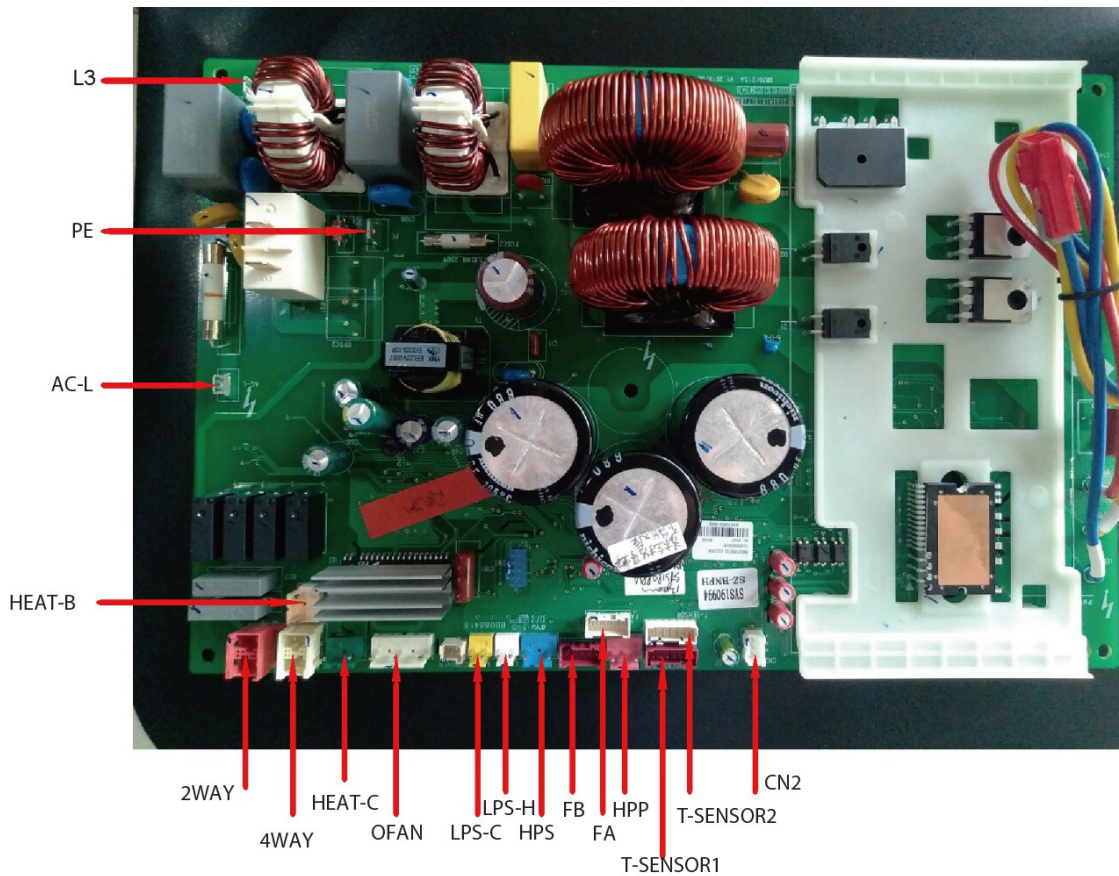

Code	Description
AC-L	Phase wire of power input
L3	Neutral wire of power input
PE	Ground
HEAT-B	Bottom band heater
EAT-C	Compressor band heater

Code	Description
2WAY	Reserved
4WAY	4-way valve coil
OFAN	DC motor
LPS-C	Low pressure switch for cooling
LPS-H	Low pressure switch for heating
HPS	High pressure switch
HPP	High pressure sensor
FA	Electronic expansion valve - coil 1
FB	Electronic expansion valve - coil 2
T_SENSOR1	1, 2: discharge; 3, 4: suction; 5, 6: outside
T_SENSOR	1, 2: Economizer inlet; 3, 4: Economizer outlet; 5, 6: Defrost
CN9	Communication 485-2 without 12 V - 3 pins

(3) PROCIDA IWU 8, PROCIDA IWU 10 (Indoor unit board)

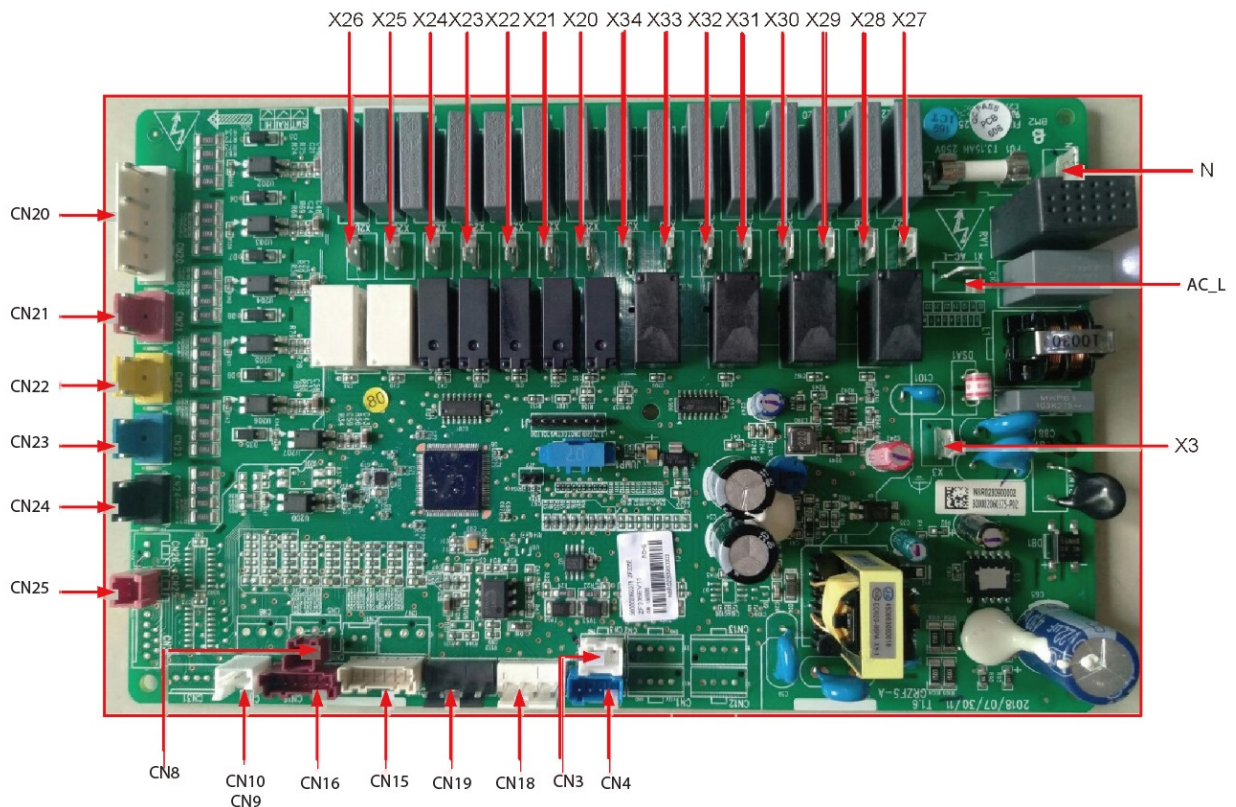

Code	Description
AC-L	Phase wire of power cable
N	Neutral wire of power cable
X3	Ground
X20	Storage tank electric heater
X21	Electric heater 1
X22	Electric heater 2
X23	Other 220VAC temperature sensor
X24	Reserved
X25	Reserved
X26	Reserved
X27	The two-way valve 1 is normally open
X28	The two-way valve 1 is normally closed
X29	Reserved

<b>Code</b>	<b>Description</b>
X30	Reserved
X31	Reserved
X32	Reserved
X33	Reserved
X34	3-way valve signal
CN30	Built-in water pump signal (PWM)
CN31	Aux. water pump signal (PWM) - provided on site
CN18	Temperature sensor 20 K (inlet water)
CN19	Temperature sensor 20 K (outlet water)
CN15	Temperature sensor 20 K (refrigerant liquid line)
CN15	Temperature sensor 20 K (outlet water)
CN15	Temperature sensor 20 K (refrigerant liquid line)
CN16	Temperature sensor 20 K (refrigerant vapour line)
CN16	Temperature sensor 10 K (outlet water for optional electric heater)
CN16	Reserved
CN8	Storage tank temperature sensor
CN9	Remote ambient temperature sensor
CN7	Reserved
CN6	Reserved
CN5	Reserved
CN20	Thermostat
CN21	Detection of welding protection for optional electric heater 1
CN22	Detection of welding protection for optional electric heater 2
CN23	Detection of welding protection for storage tank electric heater
CN24	Access detection
CN25	Flow switch
CN26	Reserved
CN3	Communication with outdoor unit
CN4	Communication with control panel

(4) PROCIDA AWS 8 (O), PROCIDA AWS 10 (O) (Outdoor unit board-Communication)

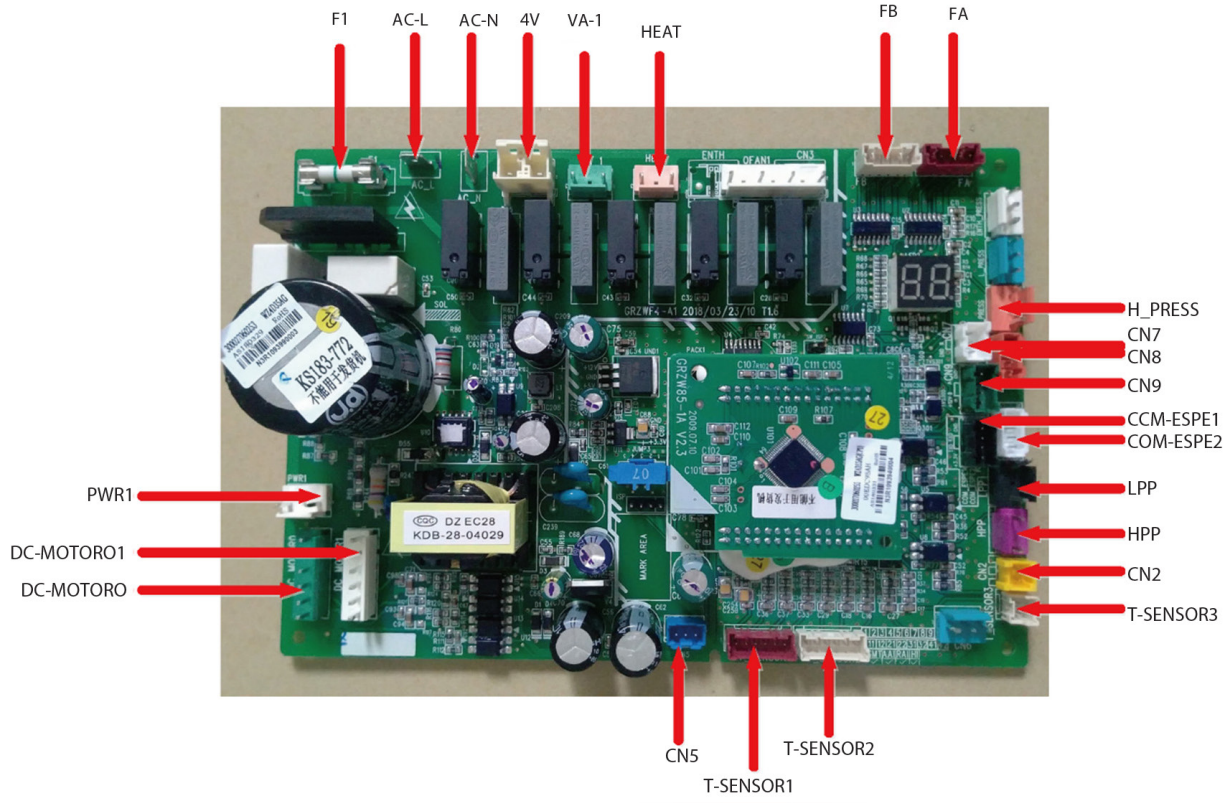

Code	Description
AC-L	Phase wire of power cable
N	Neutral wire of power cable
PWR1	Reserved
F1	Fuse
4V	4-way valve
VA-1	Chassis electric heater
HEAT	Electric heater
DC-MOTORO	Reserved
DC-MOTORO1	Fan motor
FA	EXV 1
FB	EXV 2
T_SENSOR2	1, 2: ambient; 3, 4: discharge; 5, 6: suction
T_SENSOR1	1, 2: Economizer inlet; 3, 4: Economizer outlet; 5, 6: Defrost
H_PRESS	High pressure sensor
HPP	High pressure switch
LPP	Low pressure switch for heating
CN2	Low pressure switch for cooling
CN7	Communication with indoor unit
CN8	Reserved
CN9	Reserved
COM_ESPE1	Reserved
COM_ESPE2	Communication with control panel
CN5	Reserved

(1) PROCIDA AWS 8 (O), PROCIDA AWS 10 (O) (Outdoor unit board-Power)

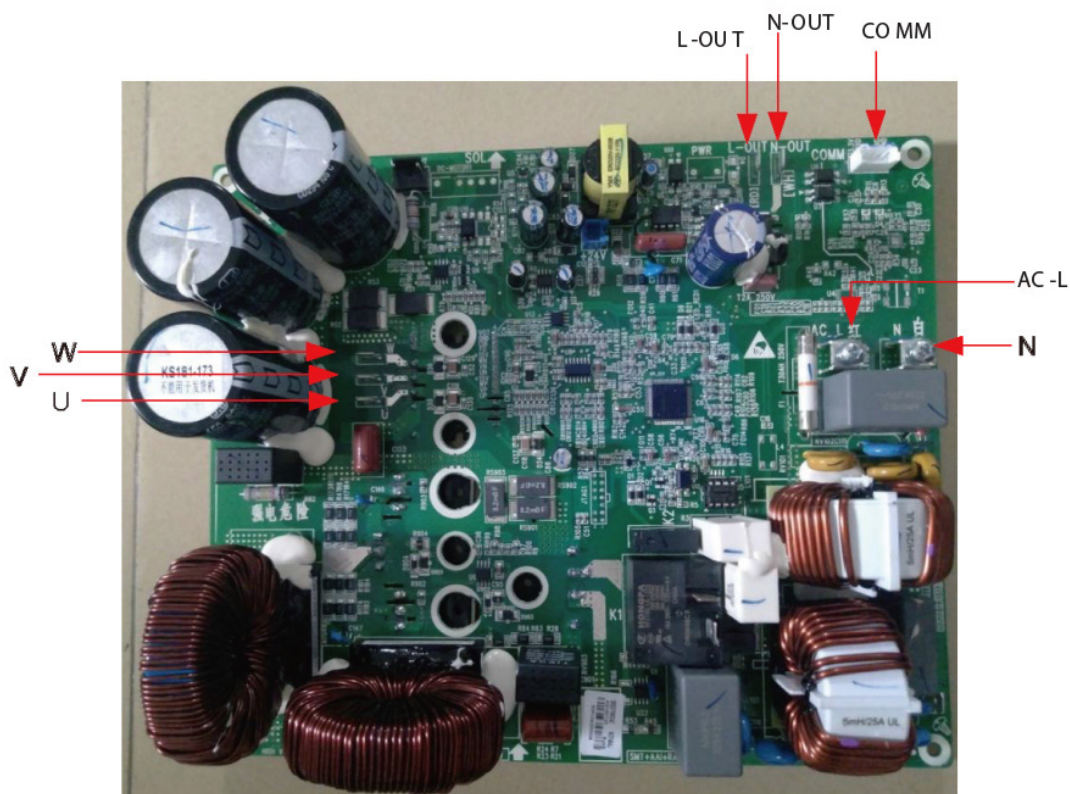

Outdoor unit

Code	Description
AC-L	Phase line input
N	Neutral line input
L-OUT	Phase line output
N-OUT	Neutral line output
COMM	Communication
U	To compressor phase U
V	To compressor phase V
W	To compressor phase W

## 20.2 Electrical connections

### 20.2.1 Connecting principle

Refer to section *Connecting principle* on page 39

### 20.2.2 Wiring diagram

(1) Wiring diagram: indoor unit (always check the wiring diagram applied to the product)

PROCIDA IWU 4, PROCIDA IWU 6, PROCIDA IWU 8, PROCIDA IWU 10

Layout of electrical components

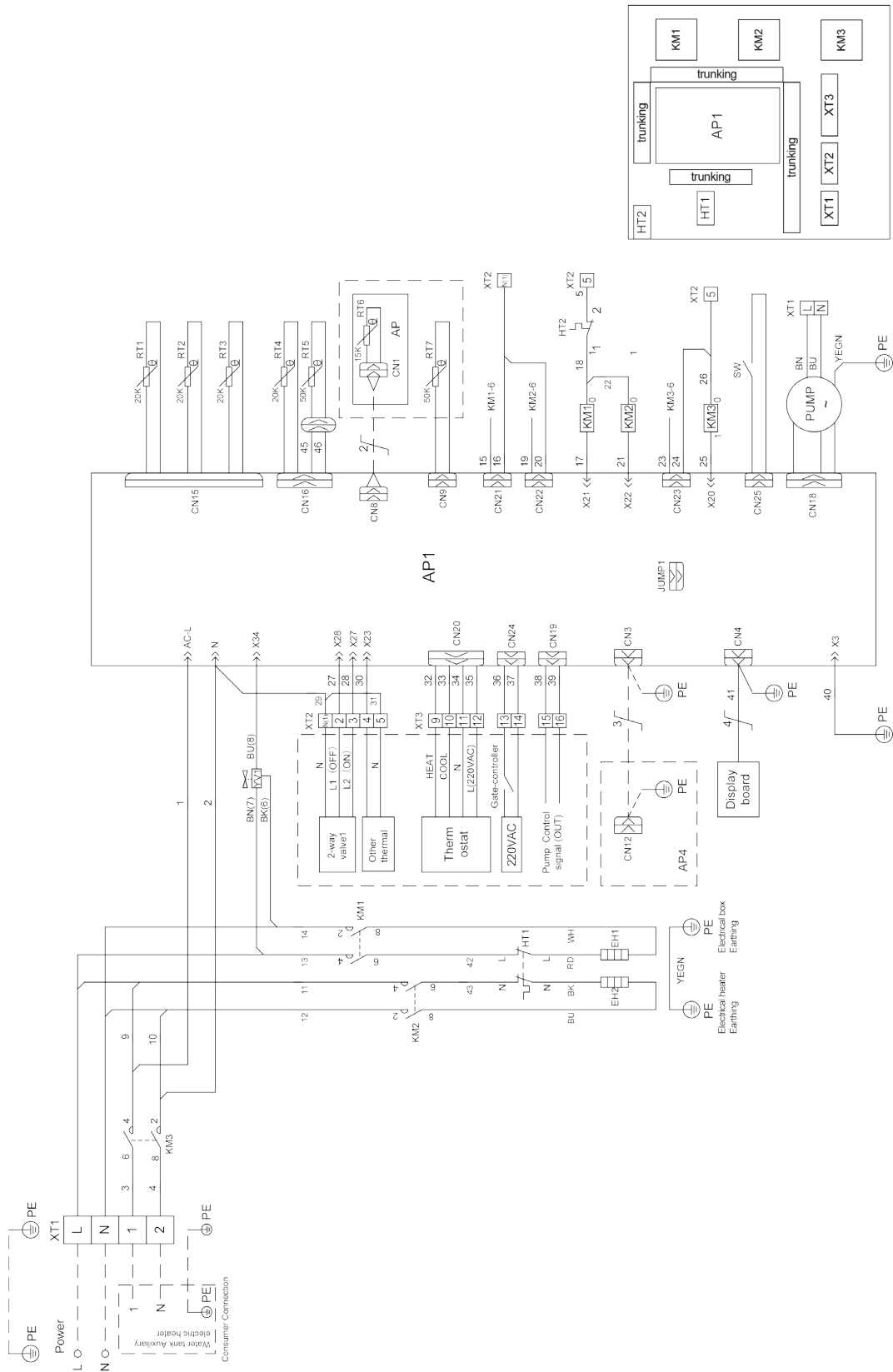

CODE	DESCRIPTION
AP	Main board - only for RT6
AP1	Indoor unit main board
AP4	Interface communication board
EH1	Optional electric heater 1
EH2	Optional electric heater 2
HT1	Thermostat 1
HT2	Thermostat 2
KM1	AC contactor 1 Optional electric heater
KM2	AC contactor 2 Optional electric heater
KM3	Storage tank electric heater AC contactor
PUMP	Indoor unit pump
RT1	Unit water inlet T sensor
RT2	Unit water outlet T sensor
RT3	Liquid tube T sensor
RT4	Gas pipe T sensor
RT5	Water T sensor - option
RT6	Remote ambient probe T sensor
RT7	Water heater temperature sensor
SW	Flow rate switch
XT1	Power supply terminal board
XT2	Terminal board
XT3	Terminal board
YV1	Electric ball valve actuator

### **Specifications**

- Terminal board wires must be connected on site.



(2) Wiring diagram: outdoor unit

PROCIDAAWS 4 (O), PROCIDAAWS 6 (O)

Layout of electrical components

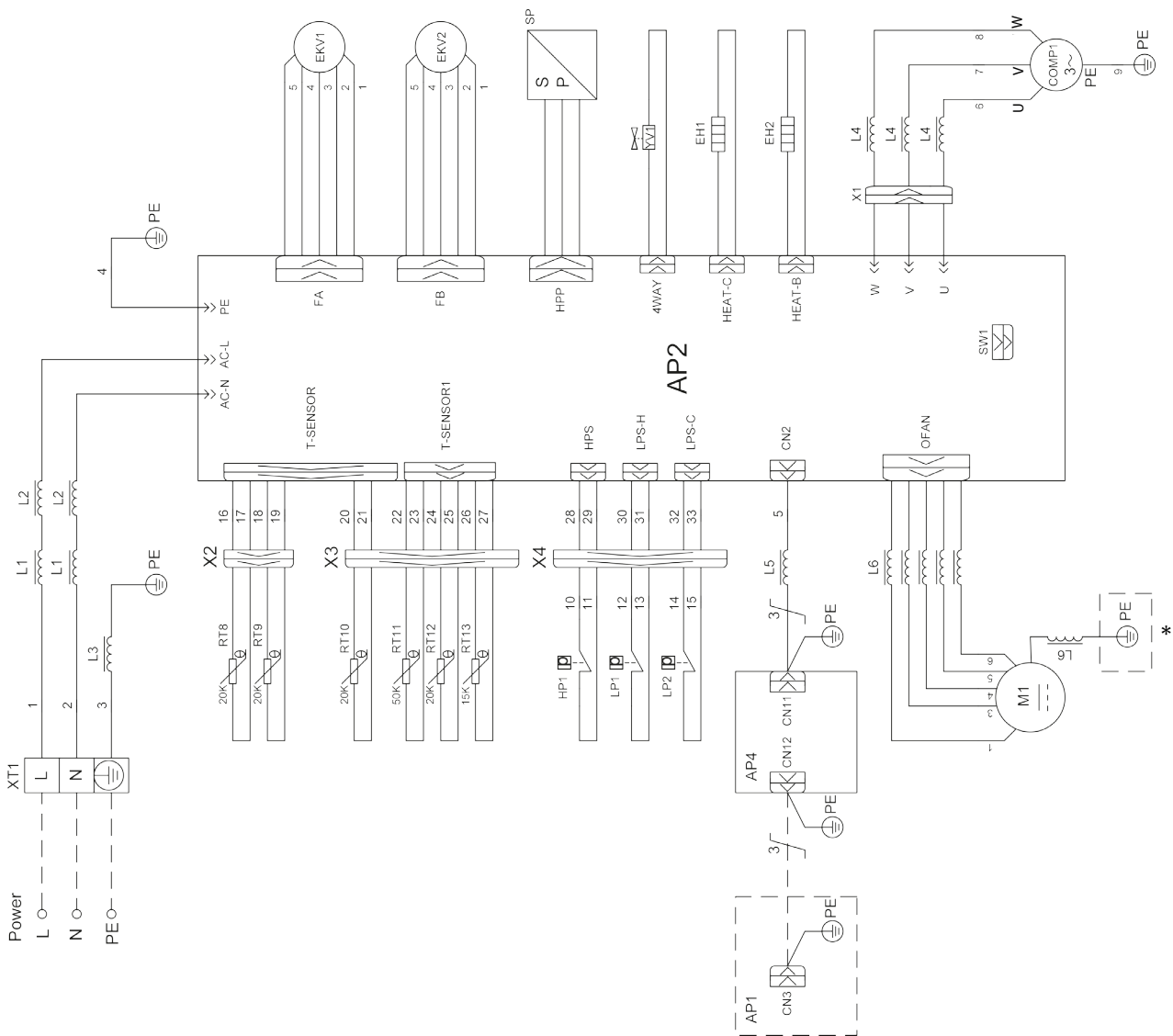
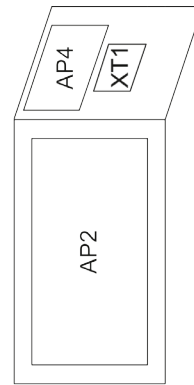

\* The ground wire is available for motor having an iron housing, while it is not available for motor having a plastic housing

<b>CODE</b>	<b>DESCRIPTION</b>
AP1	Indoor unit main board
AP2	Outdoor unit main board
AP4	Communication interface board
COMP1	Compressor
EH1	Compressor band heater
EH2	Bottom band heater
EKV1	Main electronic expansion valve coil
EKV2	Aux. electronic expansion valve coil
HP1	High pressure switch
L1-L6	Magnetic ring
LP1	Low pressure switch for heating
LP2	Low pressure switch for cooling
M1	DC motor
RT8	Economizer inlet T sensor
RT9	Economizer outlet T sensor
RT10	Defrost T sensor
RT11	Discharge T sensor
RT12	Suction T sensor
RT13	External T sensor
SP	High pressure sensor
XT1	Power supply terminal board
YV1	4-way valve coil

**Specifications**

- Terminal board wires must be connected on site.

Layout of electrical components

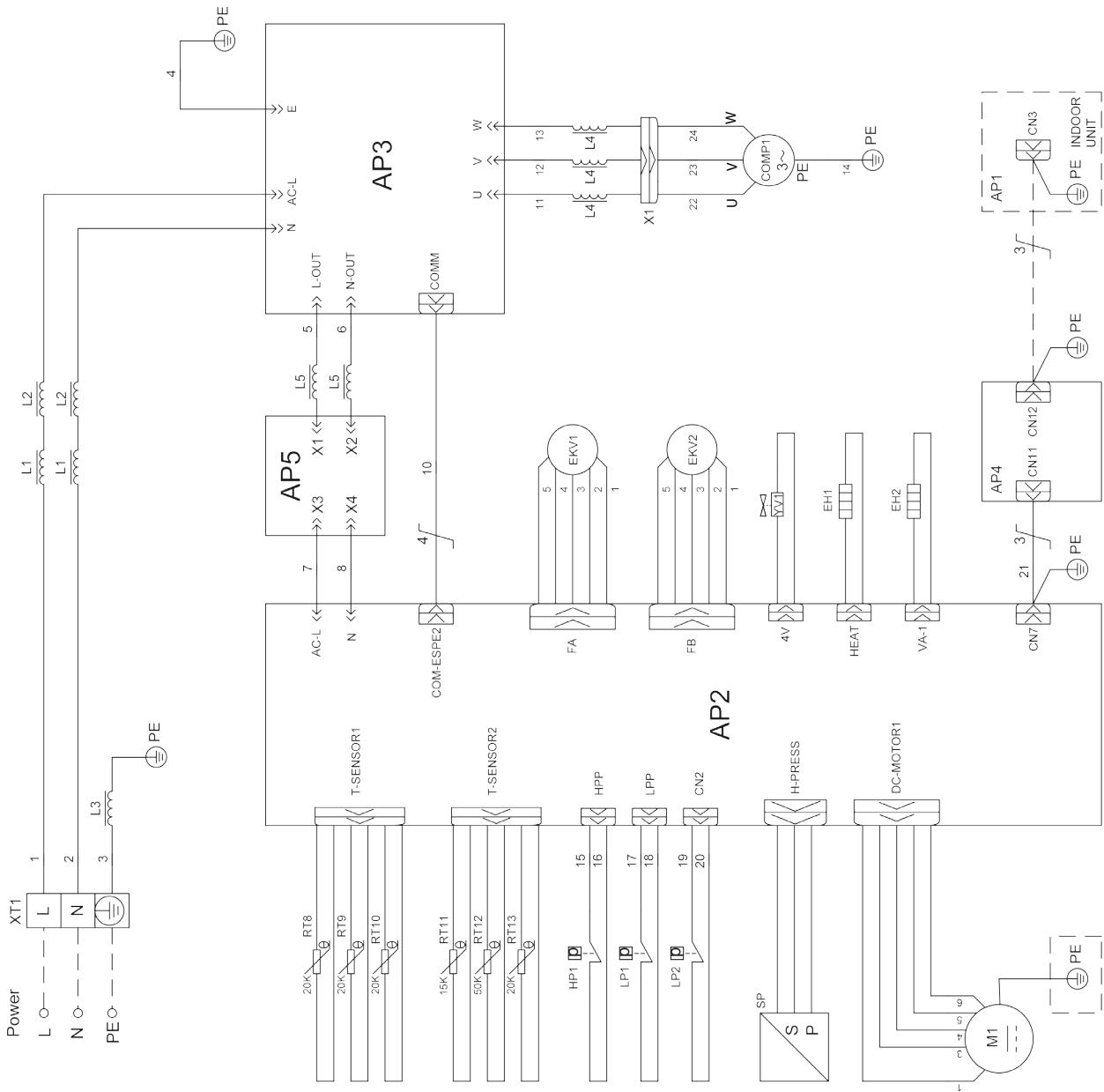
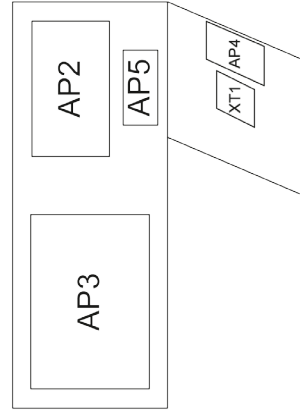

\* The ground wire is available for motor having an iron housing, while it is not available for motor having a plastic housing

CODE	DESCRIPTION
AP1	Indoor unit main board
AP2	Outdoor unit main board
AP3	Drive board
AP4	Communication interface board
AP5	Filter board
COMP1	Compressor
EH1	Compressor band heater
EH2	Bottom band heater
EKV1	Main electronic expansion valve coil
EKV2	Aux. electronic expansion valve coil
HP1	High pressure switch
L1-L5	Magnetic ring
LP1	Low pressure switch for heating
LP2	Low pressure switch for cooling
M1	DC motor
RT8	Economizer inlet T sensor
RT9	Economizer outlet T sensor
RT10	Defrost T sensor
RT11	External T sensor
RT12	Discharge T sensor
RT13	Suction T sensor
SP	High pressure sensor
XT1	Power supply terminal board
YV1	4-way valve coil

### **Specifications**

- Terminal board wires must be connected on site.

Connection between indoor unit and outdoor unit (communication cable and storage tank sensor present among accessories)

Indoor unit board

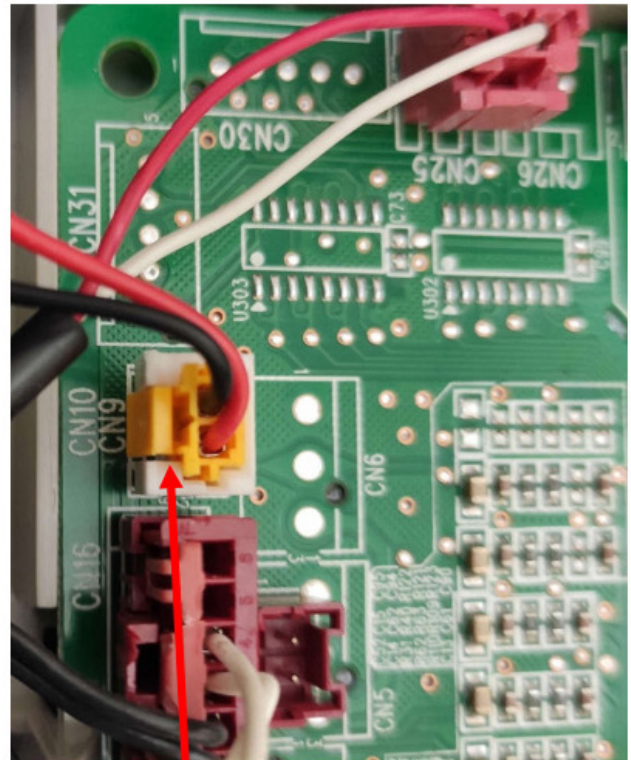
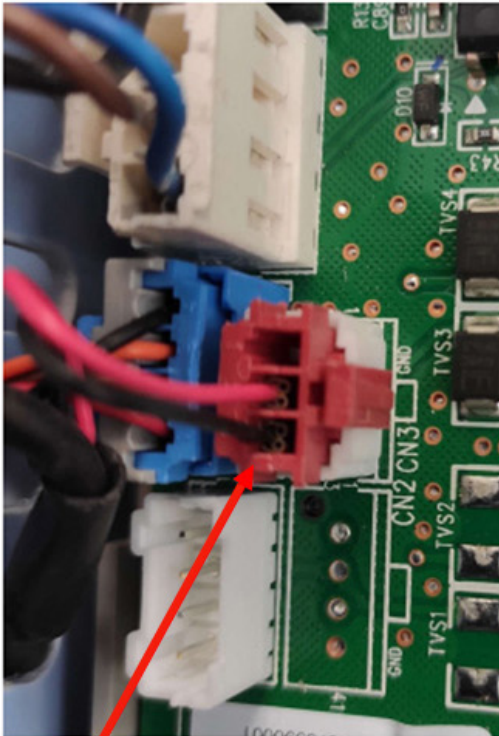

CN10 (mod.4 and 6) - CN8 (models 8 and 10) - Storage tank temperature sensor

CN3-Communication with outdoor unit (from CN12)

Outdoor unit communication board

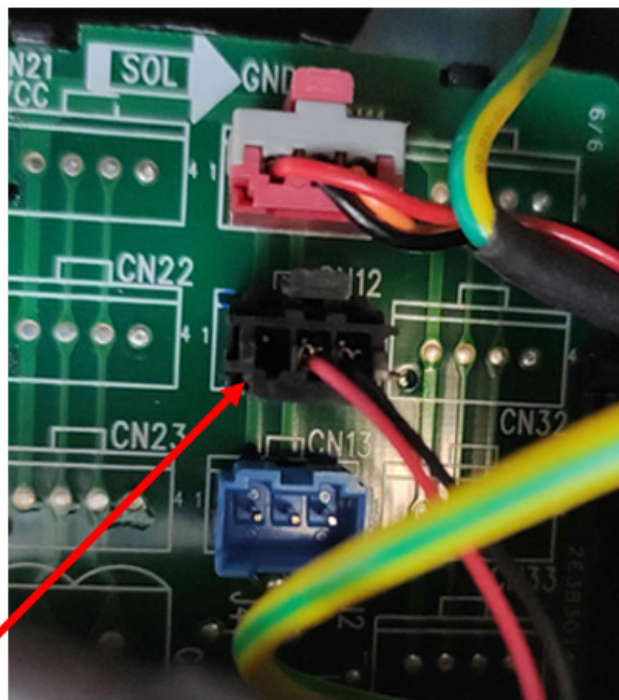

CN12-Communication with outdoor unit (from CN3)

### 20.2.3 Terminal board

PROCIDA IWU 4, PROCIDA IWU 6, PROCIDA IWU 8, PROCIDA IWU 10

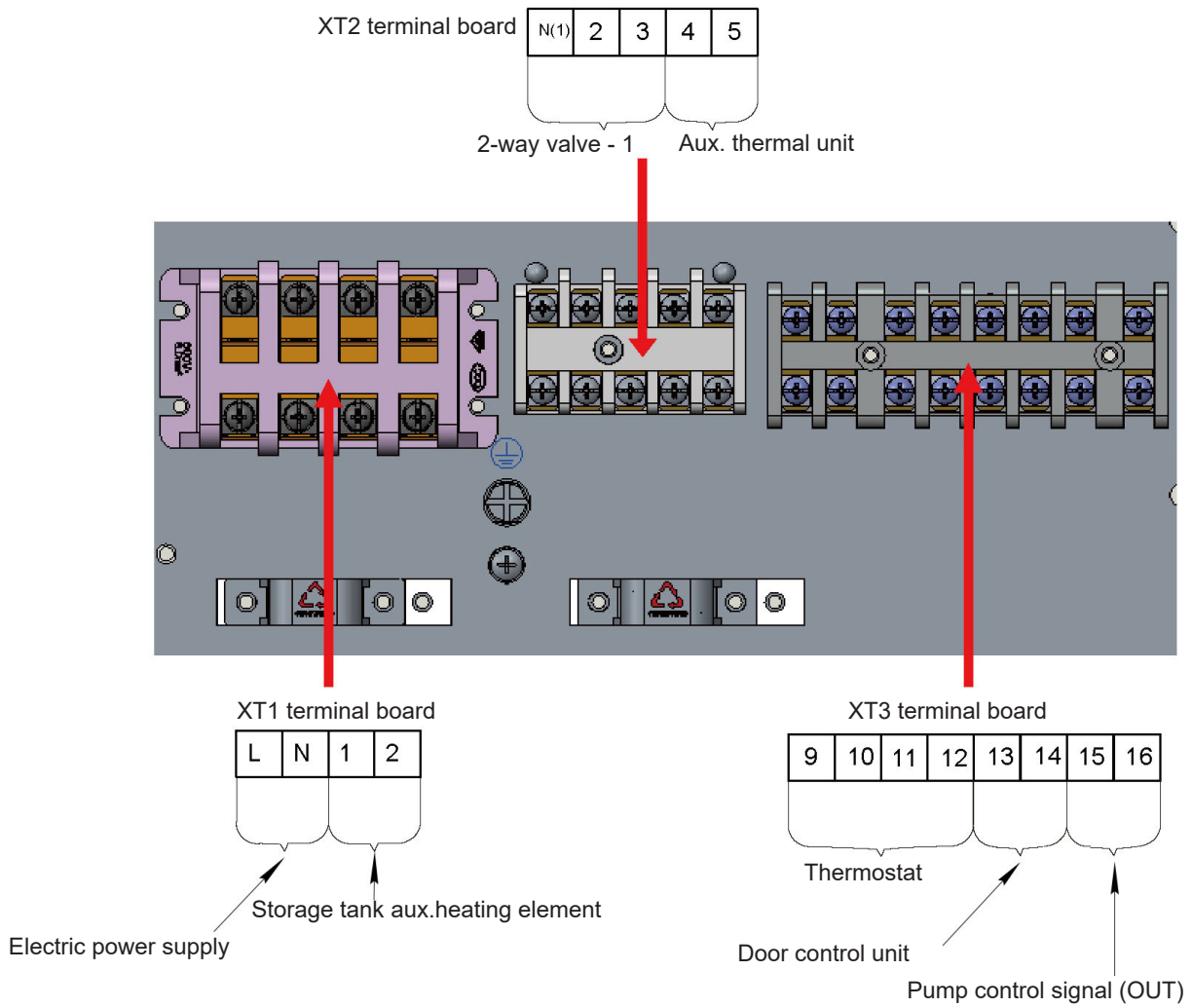

## 21. Commissioning





### 21.1 Checks before start-up

To ensure safety for users and the unit, the system must undergo a functional inspection before testing. The required procedures are described here below:

The following inspections must be carried out by qualified service technicians.		
Together with the sales technician, dealer, installer and customer, check whether the operations below have already been performed or still have to be performed.		
<b>N.</b>	<b>Installation confirmation</b>	√
1	Check whether the content of the request to install this unit, as submitted by the installer, is true. If it is not so, testing will be rejected.	<input type="checkbox"/>
2	Is there a written report indicating that the elements to be modified are related to a non-professional installation?	<input type="checkbox"/>
3	Have request to install and testing checklist been submitted simultaneously?	<input type="checkbox"/>
<b>N.</b>	<b>Preliminary check</b>	√
1	Is the appearance of the unit and internal piping fine during handling, transport or installation?	<input type="checkbox"/>
2	Check any accessories provided with the unit, their quantity, packaging, etc.	<input type="checkbox"/>
3	Check that the necessary diagrams are available: wiring diagram, control diagram, piping design, etc.	<input type="checkbox"/>
4	Ensure that the unit installation is sufficiently stable and that there is enough room for operating and repairing it.	<input type="checkbox"/>
5	Check refrigerant pressure in every unit and check for leaks.	<input type="checkbox"/>
6	Is the water storage tank securely installed? Are supports stable when storage tank is full?	<input type="checkbox"/>
7	Are storage tank insulation, water inlet/outlet pipes and filling pipe appropriate?	<input type="checkbox"/>
8	Are storage tank pressure gauge, water temperature indicator, control unit, pressure gauge, pressure relief valve, automatic drain valve, etc. installed and properly working?	<input type="checkbox"/>
9	Do power supply values correspond to the ones on the rating plate? Are power cables complying with the applicable regulations?	<input type="checkbox"/>
10	Are power and control cables properly connected according to the wiring diagram? Is grounding connection safe? Are all terminals securely connected?	<input type="checkbox"/>
11	Are connecting pipes, water pump, pressure gauge, thermometer, valves, etc. properly installed?	<input type="checkbox"/>
12	Do system valves open and close according to their specifications?	<input type="checkbox"/>
13	Make sure that customer's staff and Party A inspectors are on site.	<input type="checkbox"/>
14	Has the installation inspection table been completed and signed by the installer?	<input type="checkbox"/>
Warning: Report to supplier if there are any items marked with x. The above items are given just for reference.		
<b>Confirmed items after preliminary check</b>		
<b>Overall assessment: Debug <input type="checkbox"/> Change <input type="checkbox"/></b>		
Assess the elements below (if indications are lacking, qualification specifications will apply).		
a: Power supply and electrical control system b: Load calculation c: Unit heating problems d: Noise problems e: Pipe problems f: Other		
Normal debugging operations can only be carried out if all installation components are qualified. In case of problems, it is necessary to solve them before doing anything. If a problem is not promptly rectified, the installer shall be liable for any costs resulting from delayed and repeated testing.		
Sending change reports to the installer.		
Was the written change report to be signed after disclosure transmitted to the installer? Yes ( ) No ( )		

## 21.2 Operation test

The operation test is preliminarily performed to make sure that the unit can operate normally. If the unit can not operate normally, identify and rectify the problems so as to obtain a satisfying test result. Before starting the operation test, ensure that all test items gave the required results. The operation test must be carried out as described in the table below:

The following procedure must be carried out by qualified and experienced service technicians.	
<b>N.</b>	<b>Starting the preliminary procedure</b>
Note: before the test, make sure that all power connections are disconnected, including any remote switches; if that is not so, dangerous conditions could occur.	
<b>1</b>	Preheat unit compressor for 8 hours.
	Warning: warm up lubricating oil at least 8 hours in advance to avoid that it may mix with refrigerant, and potentially damage the compressor when starting the unit.
<b>2</b>	Make sure that the compressor oil temperature is higher than the external ambient temperature.
	Warning: if compressor oil temperature is not higher than external ambient temperature, it means that compressor electric heating tape is damaged. In this case, the compressor could easily get damaged. It is recommended to repair the electric heating tape before starting the unit.
<b>3</b>	Check that the main power phase sequence is correct. If it is not so, rectify the sequence before proceeding.
	Before starting the unit, check again the phase sequence to avoid compressor from turning in the reverse direction, which could damage the system.
<b>4</b>	Use a universal multimeter to measure the insulation resistance across each phase and the ground, and across phases.
	Warning: unsuitable grounding could lead to risk of electrocution.
<b>N.</b>	<b>Preparing for start-up</b>
<b>1</b>	Disconnect all temporary power lines, take all protection measures and check electrical conditions for the last time. Check control circuit power supply and its voltage; _____ V must fall within the range of rated values with a $\pm 10\%$ tolerance.
<b>N.</b>	<b>Unit start-up</b>
<b>1</b>	Check all conditions required for starting up the unit: oil temperature, mode, load required, etc.
<b>2</b>	Start the unit and check operation of the various components: compressor, electrical expansion valve, fan motor, water pump, etc. Note: faulty operation could damage the unit. Do not start the unit if pressure or current is high.
Other:	
Items for acceptance after testing	Assessment or proposal concerning the overall condition of operation: good, to be changed
	Identify the potential problem (if no more details are specified, installation and testing shall be considered to be in line with the requirements).
	a. Problem with the power supply and electrical control system: b. Problem with load calculation: c. Problem with the external refrigerant system: d. Noise problem: e. Problem with the indoor unit and the piping system: h. Other problems:
	During operation, all maintenance interventions due to quality problems, such as resulting from incorrect installation and maintenance, must be charged to the user.
	<b>Acceptance</b>
Did the user receive the required training? Sign. Yes ( ) No ( )	



## 22. Operation and routine maintenance

- All protection devices are installed before delivery to avoid damaging the unit. It is recommended not to modify or remove them.
- For unit first start-up or in case of start-up after a long period of inactivity (more than 1 day) with power line disconnection, it is recommended to connect the unit to the mains in advance and preheat it for at least 8 hours.
- Do not set any objects on the unit and on accessories. Keep the area around the unit dry, clean and ventilated.
- Periodically remove the dust building up on condenser fins to keep unit efficient and avoid stops controlled by the protection devices.
- To avoid unit stop or damage because of hydraulic system clogging, periodically clean the filter of the hydraulic system and frequently check the water filling device.
- To ensure proper frost protection, do not disconnect unit power lines if ambient temperature drops below zero in winter.
- To avoid damage due to frost, it is recommended to drain water from the unit and piping if you plan not to use it for a long period. Also open storage tank plug to allow draining.
- If the storage tank is installed but the corresponding parameter is set to "Without", the storage tank features will not activate and the temperature displayed for the storage tank will always be "-30". In this case, the storage tank will be exposed to frost and other damage in case of low external temperature. This is why, after installing the storage tank, it is recommended to set it to "With". In case of failure to comply, Fondital shall not be liable for any malfunction.
- Do not switch the unit on and off too frequently and close the manual valve of the hydraulic system when the unit is used by the users.
- Frequently check the operation of every part to check for oil stains at pipe joints. If necessary, change the valves to avoid refrigerant leakage.
- Promptly contact an authorised service centre in case of unit malfunction that could not be fixed by users.

### Notes

The pressure gauge for water pressure is installed on the return line to the unit. Adjust hydraulic system pressure as follows:

- If pressure is below 0.5 bar, immediately refill with water.
- While refilling, system pressure should not exceed 2.5 bar.

Malfunctions	Causes	Possible solutions
The compressor does not start	Power supply issue.	The phase sequence is reversed.
	The connection cable is disconnected.	Check and rectify.
	Main board malfunction.	Identify the causes and perform any necessary repair.
	Compressor malfunction.	Replace compressor.
Fan is very noisy	Fan retaining bolt is loose.	Tighten fan retaining bolt.
	Fan blades touch the grille or housing.	Identify the causes and perform any necessary adjustment.
	The fan operation is not reliable.	Replace the fan.
Compressor is very noisy	Liquid refrigerant returns to compressor ("slugging").	Check that expansion valve is not damaged and that temperature sensor is not disconnected.
	Compressor internal parts damage.	If necessary, perform any required repair. Replace compressor.
The water pump is not working or has a malfunction	Power supply or terminal malfunction.	Identify the causes and perform any necessary repair.
	Relay malfunction.	Replace relay.
	Air inside the water piping.	Bleed.

Malfunctions	Causes	Possible solutions
The compressor frequently starts or stops	Insufficient or excessive quantity of refrigerant. Faulty flow in the hydraulic system. Insufficient level.	Drain or top up refrigerant. The hydraulic system is either clogged or contains some air. Check water pump, valves and piping. Clean the water filter or bleed the system. Adjust the level or add storage tanks.
The unit is not heating despite compressor is operating	Refrigerant leakage. Compressor malfunction.	Repair the leakage and top up refrigerant. Replace compressor.
Poor water heating efficiency	Faulty insulation in the hydraulic system.	Improve system insulation efficiency.
	Insufficient heat exchange in evaporator.	Check that air at unit inlet and outlet is normal and clean the evaporator.
	Insufficient refrigerant level in the unit.	Ensure that there are no refrigerant leaks from the unit.
	Obstruction of heat exchanger on water side.	Clean or replace the heat exchanger.

## 22.1 Recovery

When draining refrigerant from a system for maintenance or disposal purposes, it is recommended to remove the refrigerant in safety conditions.

If refrigerant is transferred to cylinders, only use cylinders suitable for recovering refrigerant. Make sure to have a suitable number of cylinders to store all system refrigerant. All cylinders used must be designed for the recovered refrigerant and duly labelled (i.e., special cylinders for refrigerant recovery). Cylinders must be equipped with efficient safety valve and shut off valves. Empty recovery cylinders must be disposed of and, if possible, cooled down before recovery.

Recovery equipment must be in good operating conditions together with all necessary instructions and suitable for recovering flammable refrigerants.

Moreover, it is necessary to prepare a set of properly operating calibrated scales.

Flexible hoses must be equipped with sealing joints in good conditions. Before using the recovery device, ensure it is in good operating condition, has undergone proper maintenance and all associated electrical components are sealed to avoid ignition in case of refrigerant spillage. In case of doubt, contact the manufacturer.

The recovered refrigerant must be handed back to the supplier in proper recovery cylinders, together with the relevant form for waste identification. Do not mix different types of refrigerant inside recovery units, especially in cylinders.

Should it be necessary to decommission compressors or dispose of compressor oil, drain them to an acceptable level to prevent that flammable refrigerant remains in the lubricant. The drain and recovery procedure must be carried out before returning the compressor to suppliers. To speed it up, only apply electric heating to the compressor body. Drain oil from a system only if the safety conditions are complied with.

## 22.2 Decommissioning

Before performing this procedure, it is crucial that the technician is fully familiar with the equipment and all its details. It is good practice to safely recover all refrigerants. Before proceeding, take a sample of oil and refrigerant. Before reusing the recovered refrigerant, analyse it if necessary. Check that the power supply is available.

- Become familiar with the equipment and its operation.
- Electrically insulate the system.
- Before proceeding, make sure that: if necessary, mechanical equipment for handling refrigerant cylinder is available; all personal protection devices are available and are properly used; the recovery procedure is carried out under constant supervision by a competent person; recovery equipment and cylinders comply with the prevailing regulations.
- Reduce system pressure, if possible.
- Should it not be possible to create vacuum, prepare a manifold so as to remove the refrigerant from various parts of the system.
- Make sure that the cylinder is on the scale before starting recovery.
- Start the recovery device and use it according to manufacturer's instructions.
- Do not excessively fill the cylinders (not over 80% of the liquid filling volume).
- Do not exceed maximum operating pressure of cylinders, not even temporarily.
- Once cylinders have been properly filled and the procedure is completed, promptly transfer cylinders and equipment out of the site and close all shut-off valves of the equipment.
- Before filling the recovered refrigerant into another cooling system, it must be cleaned and inspected.

## 22.3 Safety notes

**Check for the presence of refrigerant:** the technician must inspect the area using a suitable refrigerant detector, before and while servicing, so as to be aware of the presence of a potentially toxic or flammable environment. Make sure that the leak detector used is suitable for all refrigerants that may be used, i.e. it does not generate sparks, is duly sealed or intrinsically safe.

**Presence of fire extinguisher:** if hot work is to be carried out on cooling equipment or any associated components, a suitable fire extinguisher must be kept at hand. Have a CO<sub>2</sub> or dry powder fire extinguisher near the refill area.

**Ventilated area:** make sure that the area is outdoors or at least suitably ventilated before gaining access to the system or performing any hot work. A certain ventilation must be maintained during the intervention. Ventilation must safely disperse any refrigerant possibly released and must preferably vent it outside, in the atmosphere.

**Inspecting the cooling system:** any electrical components installed as replacement must be suitable for the purpose and to the appropriate specifications. The manufacturer's maintenance and service instructions must be followed under all circumstances. If in doubt, consult the manufacturer's technical department.

**Inspecting the electrical devices:** check that capacitors are discharged. This procedure must be carried out in a safe manner to avoid the possibility of sparks. Make sure that there are no live components or wires exposed when filling, restoring or bleeding the system.

**Repairing the sealed components:** when repairing sealed components, it is necessary to disconnect all electrical devices from the equipment before removing sealed covers, etc. If it is absolutely necessary to have a power supply during the intervention, a permanently operating leak detection device must be set up at the most critical point to signal potentially dangerous situations. Spare parts must comply with the manufacturer's specifications.

**Repairing intrinsically safe components:** before applying permanent inductance or capacity loads to the circuit, make sure that this operation does not cause the allowed voltage and current values for the device in use to be exceeded. When replacing components, use only those parts specified by the manufacturer. Non-approved components could cause ignition of the refrigerant released into the atmosphere.

**Wiring:** check that the wiring is not exposed to wear, corrosion, excessive pressure, vibration, sharp edges or other adverse environmental factors. The inspection should also take into account the effects of ageing or continuous vibration from compressors, fans or other similar sources.

**Detecting flammable refrigerants:** the use of potential ignition sources to search for or detect refrigerant leaks is forbidden under any circumstances. The use of halogen lights (or other open flame detection systems) is not permitted.

**Methods for detecting leaks:** Leak detection liquids are suitable for use with most refrigerants; however, the use of detergents containing chlorine should be avoided as the latter may react with the refrigerant and corrode copper piping.

## 22.4 Precautions before seasonal use

- Ensure that air inlets and outlets of indoor and outdoor units are not clogged.
- Ensure that grounding connection is safe.
- In case of restarting after a long period of inactivity, switch on the unit 8 hours before operation should start so as to allow preheating of the external compressor.
- Precautions to prevent freezing in winter. If temperature drops below zero in winter, it is necessary to add an antifreeze fluid to the hydraulic circuit and duly insulate water piping on the outside. It is recommended to use a glycol-based solution as antifreeze fluid.

Concentration [%]	Freezing temp. [°C]
4,6	- 2
8,4	- 4
12,2	- 5
16	- 7
19,8	- 10
23,6	- 13
27,4	- 15
31,2	- 17
35	- 21
38,8	- 26
42,6	- 29
46,4	- 33

Note: "concentration" values indicated in the table refer to mass concentration.

### **REGULATION (EU) No. 517/2014 - F-GAS**

The unit contains R32, a fluorinated greenhouse gas having a global warming potential (GWP) = 675. Do not release R32 into the environment.

Model	
PROCIDA AWS X4	1 kg = 0.675 tons of CO <sub>2</sub> equivalent
PROCIDA AWS X6	1 kg = 0.675 tons of CO <sub>2</sub> equivalent
PROCIDA AWS X8	1.6 kg = 1.08 tons of CO <sub>2</sub> equivalent
PROCIDA AWS X10	1.6 kg = 1.08 tons of CO <sub>2</sub> equivalent

Page left intentionally blank

Page left intentionally blank



Fondital S.p.A. - Società a unico socio  
25079 VOBARNO (Brescia) Italy - Via Cerreto, 40  
Tel. +39 0365 878 31  
Fax +39 0365 878 304  
e-mail: [info@fondital.it](mailto:info@fondital.it)  
[www.fondital.com](http://www.fondital.com)

The manufacturer reserves the right to modify his/her products as deemed necessary, without altering the basic characteristics of the products themselves.

Uff. Pubblicità Fondital IST 03 J 048 - 02 | Febbraio 2023 (02/2023)