

ITACA
KC 12-24-28-32
KR 12-24-28-32
KRB 12-24-28-32

INSTALLATION, USE AND MAINTENANCE



CE

EN

Translation of the original instructions (in Italian)



It is compulsory to read this manual before proceeding with the boiler installation, use and maintenance operations.

This boiler is intended for production of hot technical water only:

- For heating of residential, commercial and industrial rooms.
- For heating of industrial process water.
- For indirect production of domestic hot water.

Any other use is forbidden.

Dear Sirs,
thank You for choosing and buying one of our products. Please read these instructions carefully in order to properly install, operate, and maintain the product.



WARNING

We inform users that:

- Boilers shall be installed by an authorised company under the requirements set forth by the prevailing rules, in full compliance with the prevailing regulations and standards.
 - Anyone entrusting installation to an unqualified installer will be subject to administrative sanctions.
 - Boilers must be maintained by qualified personnel only, under the requirements set forth by the prevailing rules.
-



WARNING

According to European Directive 2012/19/EU on waste electrical and electronic equipment (WEEE) the crossed-out wheeled bin symbol indicated on the boiler and on the package means that the boiler, at the time of its decommissioning, must be collected and disposed of separately from other waste (see *Decommissioning, disassembly and disposal*).

We hereby inform you that certain models, versions and/or accessories relevant to the products this manual refers to, might not be available in some countries.

Therefore, it is recommended to contact the manufacturer or the importer in order to get the necessary information about the actual availability of such models, versions and/or accessories.

The manufacturer reserves the right to modify the products and/or its components as deemed necessary, in any moment and without prior notice.

This instruction manual is available in two languages, Italian and English, without prejudice to the prevalence of Italian language in case of differences in translation and/or dispute on construction of the text.

General notes for installing and maintenance technicians, and users

This instruction manual is an integral and essential part of the product. It shall be supplied by the installer to the user who shall keep it carefully to consult it whenever necessary.

This document shall be supplied together with the equipment in case the latter is sold or transferred to others.



WARNING

This boiler is intended for production of hot technical water only:

- For heating of residential, commercial and industrial rooms.
- For heating of industrial process water.
- For indirect production of domestic hot water.

Any other use is forbidden.



DANGER

This boiler must be installed by qualified personnel.

The installation by unqualified personnel is forbidden.



DANGER

This boiler must be installed in compliance with the requirements of the technical standards and legislation in force relating to gas appliances, particularly with reference to ventilation of the premises.

Any installation that does not comply with the requirements of the technical standards and legislation in force is forbidden.



DANGER

This boiler must be installed according to the manufacturer's instructions given in this manual. Incorrect installation may cause injury to persons and/or animals and damage to property. The manufacturer shall not be held liable for any such injury and/or damage.



WARNING

This boiler must be installed inside the building or in a partially sheltered place.

A partially sheltered place is a place which is not directly exposed to atmospheric agents.

Any installation in a place that is not partially sheltered is forbidden.



DANGER

This boiler must be correctly and safely connected to an electrical system compliant with the existing technical standards.

Any incorrect and unsafe connection to the electrical system is forbidden.

It is forbidden to connect the boiler to an electrical system lacking a differential switch to protect the boiler power line.

Any connection to an electrical system lacking a proper grounding system is forbidden.



WARNING

The boiler is supplied with a three-poled power cable, already connected to the electronic board and it is provided with a safety clamp.

This boiler must be connected to a 230V power supply network, as indicated on the label affixed to the power cable.

**DANGER**

Carefully read the instructions relating to air intake and flue gas venting systems in the specific section of this manual.

**DANGER**

This boiler must be connected to a gas distribution system which complies with the existing technical standards.

Check the gas system state of conservation before installing the boiler.

Any connection to a gas system which does not comply with the existing technical standards is forbidden.

When connecting the boiler to gas supply network, it is compulsory to install an appropriately sized gasket made from suitable material.

The boiler gas inlet coupling is not suitable for hemp, teflon tape or similarly made gaskets.

After connecting the boiler, check the connection for tightness.

Once gas is in the pipes, leak test by a naked flame is forbidden; use specific products available on the market.

**DANGER**

With gas fired boilers, take the following measures if you smell gas:

- **Do not turn on or off electric switches and do not turn on electric appliances.**
- **Do not ignite flames and do not smoke.**
- **Close the main gas cock.**
- **Open doors and windows.**
- **Contact a Service Centre, a qualified installer or the gas supply company.**

Never use a flame to locate a gas leak.

The boiler is designed for installation in the countries indicated on the technical data plate: installation in any other country may be a source of danger for people, animals and/or property.

The manufacturer will bear no contractual and tortious liability for failure to comply with all the instructions above.

Before installing the boiler, check that the technical data correspond to the requirements for its correct use in the system.

Check that the boiler is intact and it has not been damaged during transport and handling. Do not install equipment which is clearly damaged and/or faulty.

Damage and/or injury caused by incorrect installation or use and/or damage and/or injury due to non-observance of the manufacturer's instructions shall release the manufacturer from any and all contractual and extra-contractual liability.

Do not obstruct the air intake openings.

Only original accessories or optional kits (including the electric ones) are to be installed.

Properly dispose of the packaging as all the materials can be recycled. The packaging must therefore be sent to specific waste management sites.

After removing the packaging, make sure that its elements (clips, plastic bags, foam polystyrene etc.) are not left within the reach of children as they are potential hazard sources.

In the event of failure and/or faulty functioning, switch off the boiler. Do not attempt to make repairs: contact qualified technicians.

Original parts must be used for all repairs to the boiler.

Non-observance of the above requirements may affect the safety of the boilers and endanger people, animals and/or property.

This appliance is not intended for use by persons (including children) with reduced physical, sensory or mental capabilities, or lack of experience and knowledge, unless they have been given supervision or instruction concerning use of the appliance by a person responsible for their safety.

Children should be supervised to ensure that they do not play with the appliance.

**DANGER**

Before starting the boiler, and each time it is at a standstill for several days, make sure the trap is full of water. If the trap is empty, fill it by pouring water into the boiler through the flue gas venting duct.

**WARNING**

The boiler must be serviced periodically as indicated in the relevant section of this manual. Appropriate boiler maintenance ensures efficient operation, environment preservation, and safety for people, animals and objects. Incorrect and irregular maintenance can be a source of danger for people, animals and property.

The user is strongly advised to have the system serviced and repaired by qualified personnel, satisfying all prevailing law requirements, and trained to properly carry out these operations.

In the event of long periods of inactivity of the boiler, disconnect it from the electrical power mains and close the gas cock.

**WARNING**

With the electrical power disconnected and the gas tap closed, the device's electrical anti-freeze function does not work.

Should there be a risk of freezing, add antifreeze: it is not advisable to drain the system as this may result in damage; use specific anti-freeze products suitable for multi-metal heating systems.

**DANGER**

Damage and/or injury caused by incorrect installation and/or incorrect use and/or unauthorized changes to the boiler and/or non-observance of the manufacturer's instructions and/or of the relative standards/laws in force in the country of installation, shall release the manufacturer from any and all liability.

Rapid operating instructions

The following instructions will help you to switch the boiler on quickly and regulate it for immediate use.





WARNING



It is presumed that the boiler has been installed by a qualified installer, it has been commissioned and is ready to operate correctly.

If any accessories have been fitted on the boiler, these instructions will not cover them. You will therefore have to refer to the full boiler instructions as well as to the specific instructions for the accessories.

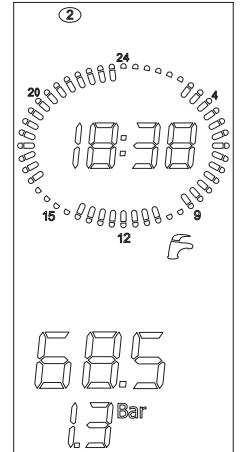

This manual contains full details of how the boiler works, and full operating and safety instructions.

1. Open the gas cock installed ahead of the boiler.
2. Turn the master switch installed ahead of the boiler **ON**; the boiler display turns on.
3. If you do not wish to activate the CH function, press the  button until displaying the symbol : only the DHW function will be enabled.

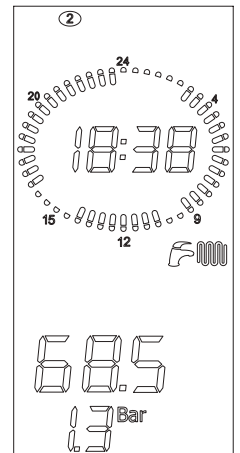

4. If you wish to activate both the heating and DHW functions, press the  button until displaying the symbol .



5. If you do not wish to activate the DHW function, press the  button until displaying the symbol : only the CH function will be enabled.
6. To set the domestic hot water temperature, press **DHW +/-** buttons.
7. To set the heating water temperature, press **CH +/-** buttons.
8. Set the desired temperature on the (optional) ambient thermostat in the building. The boiler is now ready to operate.

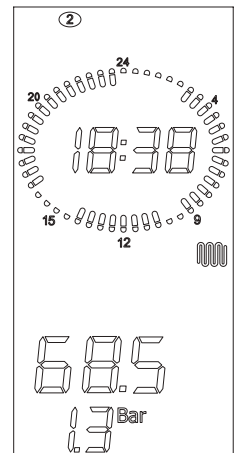

If the boiler shuts down, press button 

If boiler does not resume its operation after three attempts, contact a qualified Service Centre.

1.	Instructions for the user	11
1.1	Control panel	11
1.2	Interpreting boiler status from display indications	13
1.3	Selecting the operating mode	15
1.4	Adjusting heating and DHW temperature	15
1.5	Comfort function enable/disable	16
1.6	Time setting	16
1.7	"Day temperature" and "night temperature" setting	17
1.8	"Manual" programme setting	18
1.9	"Automatic" programme setting	18
1.10	CH programme mode	19
1.11	Parameter display	20
1.12	Failures that cannot be reset	20
1.13	Resume boiler function	20
1.14	Boiler operation	21
1.15	Boiler shut-down	25
1.16	Maintenance	27
1.17	Notes for the user	27
2.	Technical features and dimensions	28
2.1	Technical features	28
2.2	Dimensions	30
2.3	Boiler layouts	33
2.4	Operating data	36
2.5	General characteristics	37
2.6	ERP and Labelling data	40
3.	Instructions for the installer	42
3.1	Installation standards	42
3.2	Choosing where to install the boiler	42
3.3	Positioning the boiler	42
3.4	Installing the boiler	44
3.5	Boiler room ventilation	44
3.6	Air intake and flue gas venting system	45
3.7	Checking combustion efficiency	55
3.8	Connection to gas mains	56
3.9	Hydraulic connections	56
3.10	Connection to electrical mains	58
3.11	Connection to ambient thermostat (optional)	58
3.12	Installation of the (optional) external probe and sliding temperature operation	58
3.13	Room temperature installation	60
3.14	Selecting the operating range in heating mode	60
3.15	Installation and operation with Open Therm Remote Control (optional)	61
3.16	TSP parameters	62
3.17	Filling the system	67
3.18	Starting up the boiler	67
3.19	Available head	68
3.20	Wiring diagrams	71
3.21	Adaptation to other gas types and burner adjustment	83
4.	Testing the boiler	87
4.1	Preliminary checks	87
4.2	Switching on and switching off	87
5.	Maintenance	88
5.1	Maintenance schedule	88
5.2	Combustion analysis	89
5.3	Extraordinary maintenance	89
6.	Decommissioning, disassembly and disposal	91

7.	<i>Malfunctions, possible causes and solutions</i>	92
7.1	<i>Troubleshooting</i>	92

Fig. 1 Control panel	11
Fig. 2 Filler cocks	25
Fig. 3 Model KC dimensions.	30
Fig. 4 Model KR dimensions.	31
Fig. 5 Model KRB dimensions	32
Fig. 6 Model KC hydraulic layout	33
Fig. 7 Model KR hydraulic layout	34
Fig. 8 Model KRB hydraulic layout	35
Fig. 9 Paper template	43
Fig. 10 Split kit installation	46
Fig. 11 Coaxial kit installation	46
Fig. 12 Installation examples	47
Fig. 13 Pipe installation	47
Fig. 14 Wall-mounted terminal installation	48
Fig. 15 Tile for pitched roofs	48
Fig. 16 Roof flue installation	49
Fig. 17 Coaxial ducts C33 distance specs	52
Fig. 18 Coaxial ducts C43 - C53 - C83.	54
Fig. 19 Coaxial ducts C43 - C53 - C83 dimensions	54
Fig. 20 Plugs position	55
Fig. 21 Hole position.	55
Fig. 22 Connection to gas mains	56
Fig. 23 Condensate drain	57
Fig. 24 Thermoregulation curves	59
Fig. 25 Available head KC-KR-KRB 12	68
Fig. 26 Available head KC-KR-KRB 24	69
Fig. 27 Available head KC-KR-KRB 28	69
Fig. 28 Available head KC-KR-KRB 32	70
Fig. 29 Wiring diagram KC	71
Fig. 30 Wiring diagram for forced circulation solar system with combi boiler.	73
Fig. 31 Multifunction relay connection diagram	73
Fig. 32 Wiring diagram for natural circulation solar system with combi boiler	74
Fig. 33 Multifunction relay connecting diagram (X = neutral; Y = to boiler; Z = to collector)	74
Fig. 34 Wiring diagram KR	75
Fig. 35 Forced circulation solar system with CH only boiler wiring diagram.	77
Fig. 36 Multifunction relay connection diagram	77
Fig. 37 Wiring diagram KRB.	78
Fig. 38 Relay with remote control and TA2.	81
Fig. 39 Relay with remote request (P17=1)	81
Fig. 40 Relay with TA2 request (P17 = 3).	82
Fig. 41 Intake pipe	84
Fig. 42 Mixer.	84
Fig. 43 Mixer plastic body.	85
Fig. 44 Assembling direction.	85
Fig. 45 Adjusting CO2 value.	86

Tab. 1 Displayable parameters with info button	20
Tab. 2 Adjustment specifications KC-KR-KRB 12.	36
Tab. 3 Adjustment specifications KC-KR-KRB 24.	36
Tab. 4 Adjustment specifications KC-KR-KRB 28.	36
Tab. 5 Adjustment specifications KC-KR-KRB 32.	36
Tab. 6 General specifications KC models.	37
Tab. 7 General specifications KR/KRB models	38
Tab. 8 Combustion specifications KC-KR-KRB 12.	39
Tab. 9 Combustion specifications KC-KR-KRB 24	39
Tab. 10 Combustion specifications KC-KR-KRB 28	39
Tab. 11 Combustion specifications KC-KR-KRB 32	39
Tab. 12 Additional specifications.	39
Tab. 13 ERP and Labelling data - KC.	40
Tab. 14 ERP and Labelling data - KR/KRB	41
Tab. 15 Boiler re-ignition temperature	60
Tab. 16 List of parameters - I	62
Tab. 17 List of parameters - II.	63
Tab. 18 List of parameters - III	64
Tab. 19 Solar parameter (with P17=2 or with supplementary board)	65
Tab. 20 System check	65
Tab. 21 Display only	66
Tab. 22 Parameter setting	82
Tab. 23 Relationship between "Temperature and Nominal resistance" for temperature probes	82
Tab. 24 Flue CO2 content.	86
Tab. 25 Diameter of nozzles - diaphragms (mm)	86

1. Instructions for the user

1.1 Control panel

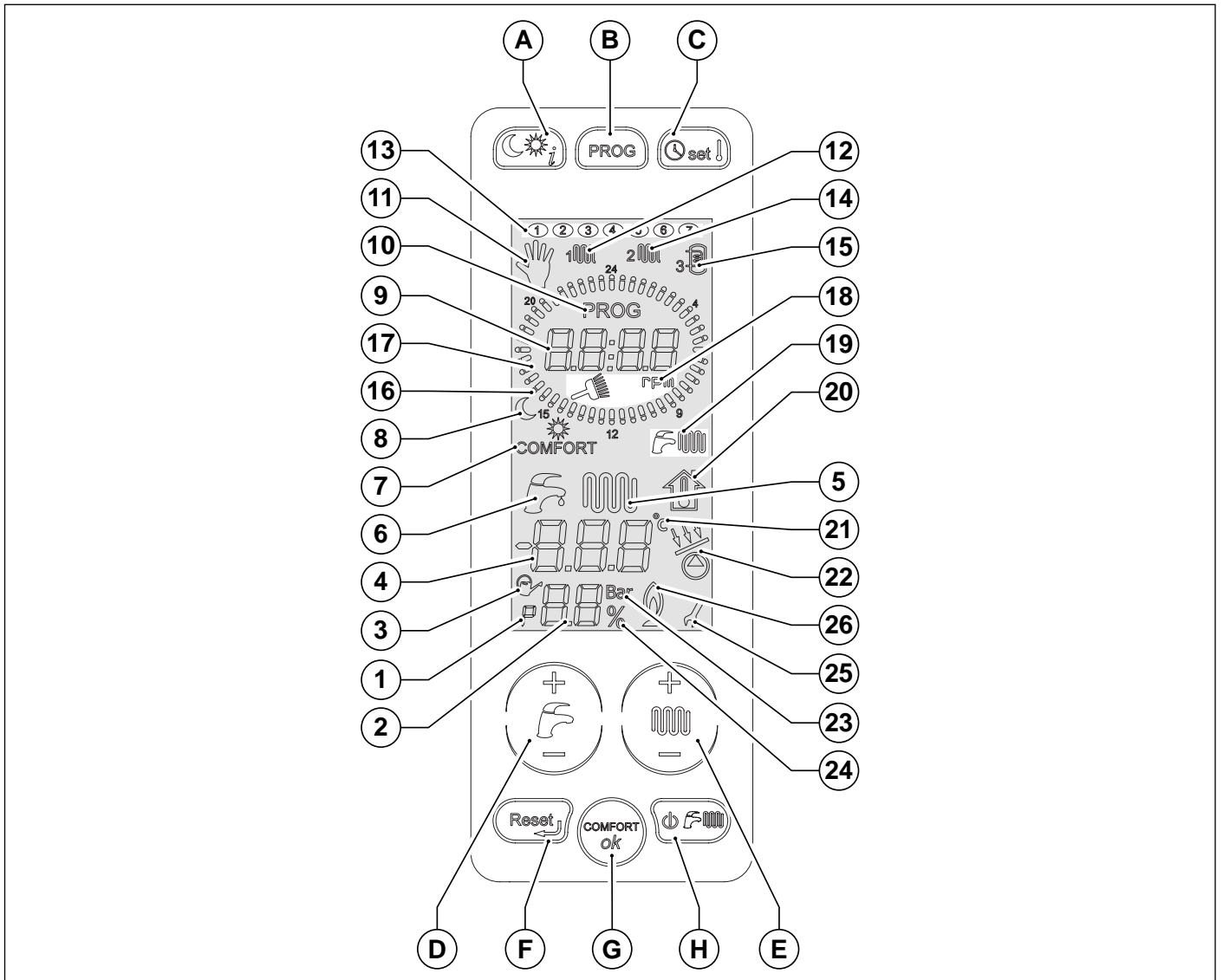







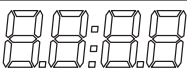















Fig. 1 Control panel

- A. Temperature selection (day/night) and information recall.
- B. Weekly programme for temperature zones and manual programme selection.
- C. Time and ambient temperature setting.
- D. Set the domestic hot water (DHW +/-).
- E. Set the heating water and the (+/- CH) settings.
- F. Alarm reset and back to the starting page during parameter selection.
- G. DHW comfort function setting and confirm button
- H. Operating status selection.

Touch the display in order to activate it. Unless an operation is performed, the display deactivates after 15 seconds.

Ref.	Symbol	Steady on	Flashing
1		Indication of "parameter" inside the parameter menu	Not used
2		Displaying of the number of parameters, or of the system pressure, or of the burner power percentage	Not used
3		Automatic filling procedure is active	Not used
4		Indication of the temperatures and values of fault and shutdown parameters	Not used
5		A heating request is present	Displaying of the heating temperature set-point
6		A DHW request is present	Displaying of the DHW temperature set-point
7	COMFORT	DHW "Comfort" function enabled	Not used
8		Current temperature (sun = day; moon = night)	Setting of the two temperatures associated with the sun and the moon
9		Display of current time/fan revolutions	Not used
10	PROG	Indicates if the unit is in time slot programming mode	Not used
11		Manual mode operation	Manual mode setting
12		Display of zone 1 heating programme	Edit zone 1 heating programme
13		Current day of the week	Edit day of the week
14		Display of zone 2 heating programme	Edit zone 2 heating programme
15		Display of water heater programme	Edit water heater programme
16		Night time temperature indication	Not used
17		Daytime temperature indication	All lights flashing: automatic mode setting
18	 rpm	Displaying of the flue cleaning function and of the "rpm" wording to show the number of revolutions per minute	Indicates that you are accessing the flue cleaning function.
19		Instantaneous DHW production and heating functions enabled	Not used
20		Not used	Display of set-point

Ref.	Symbol	Steady on	Flashing
21	°C	Indication of the centigrade degrees	Not used
22		Solar pump or solar valve active	Not used
23	Bar	Indication of system pressure measurement unit	Not used
24	%	Percentage indication	Not used
25		During parameter editing, the wrench symbol stays on until the set datum is confirmed.	Not used
26		Lit flame indication	Not used

1.2 Interpreting boiler status from display indications

1.2.1 Normal operation

Boiler switch in OFF mode.

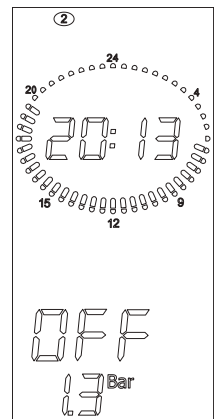

Boiler switch in SUMMER or WINTER mode or CH ONLY.

No active function.

The flow temperature and the heating system pressure are displayed.

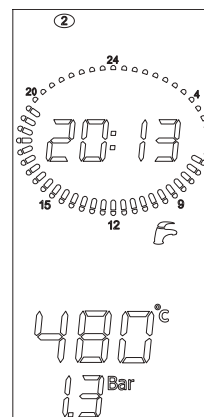

SUMMER

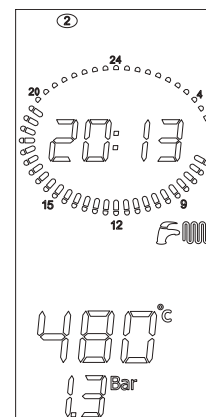

WINTER

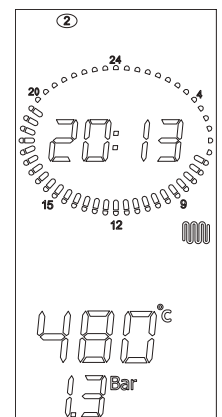

CENTRAL HEATING ONLY

Boiler switch in SUMMER or WINTER mode.
 DHW function enabled.
 DHW temperature is displayed.
 For models KC only.

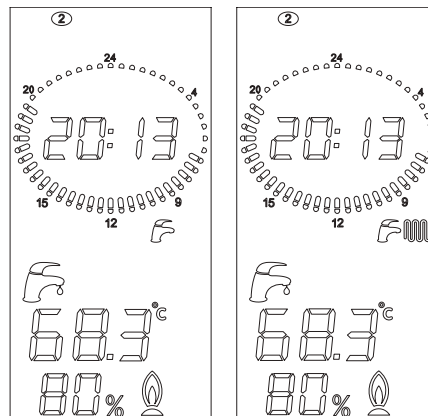

SUMMER

WINTER

Boiler switch in WINTER mode or CH ONLY.
 CH function active.
 The flow water temperature is displayed.

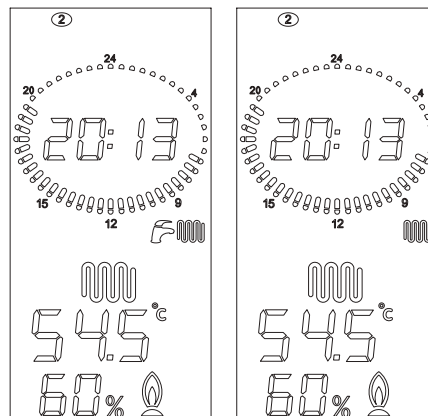

WINTER

CENTRAL HEATING ONLY

Boiler switch in SUMMER or WINTER mode.
 External water heater enabled
 DHW temperature is displayed.
 For models KR and KRB with optional water heater, only.

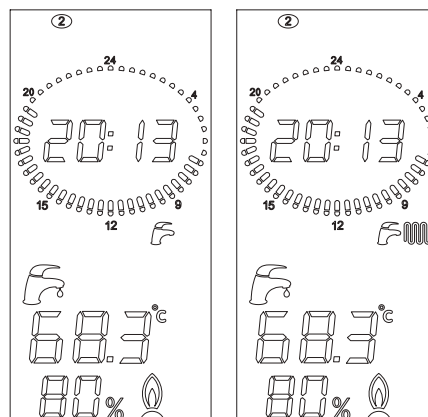

SUMMER

WINTER

1.2.2 Malfunction

To identify any malfunctions, refer to paragraph *Troubleshooting* on page 92.

1.3 Selecting the operating mode

Whenever  key is pressed, the "SUMMER", "WINTER", "CH ONLY", "OFF" modes are enabled in sequence. At this stage, all buttons are enabled.

1. "OFF" operating status

When the "OFF" mode is enabled, no function is active.

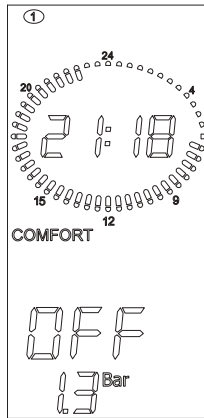

2. "SUMMER" operating status

When the "SUMMER" mode is enabled, only the DHW production function is active.

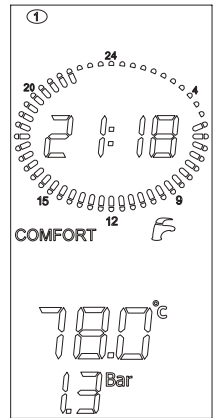

3. "WINTER" operating status

When the "WINTER" mode is enabled, both DHW and CH functions are active.

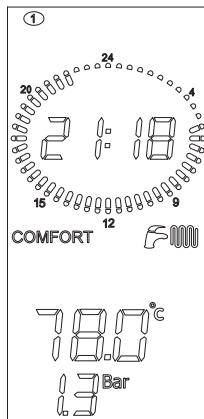

4. "CH ONLY" operating status

When the "CH ONLY" mode is enabled, only the heating water production function is active.

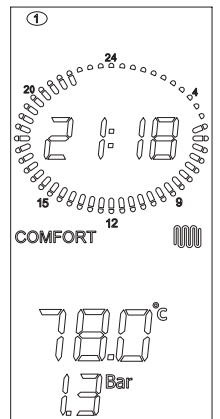

1.4 Adjusting heating and DHW temperature

Press button **+/- DHW** to select the desired DHW temperature.

During selection,  icon will flash. In the phase in which the icon is flashing, only the buttons to adjust the temperature are enabled.

As soon as button is released, icon will continue flashing for approx. 3 seconds, and temperature value will flash as well. After this time, value is stored and display standard operation will be restored.

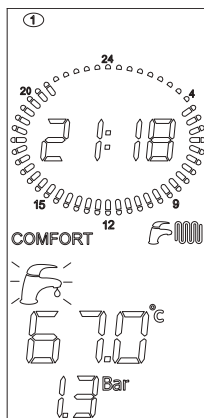

Press **CH +/-** button to select the desired flow water temperature.

During selection,  icon will flash. In the phase in which the icon is flashing, only the buttons to adjust the temperature are enabled.

As soon as button is released, icon will continue flashing for approx. 3 seconds, and temperature value will flash as well. After this time, value is stored and display standard operation will be restored.

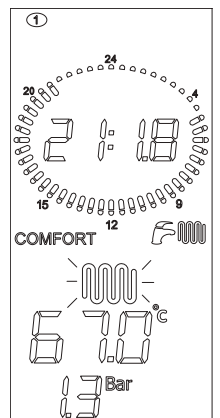

1.5 Comfort function enable/disable

This function keeps the plate heat exchanger hot, to minimise the waiting time for the production of DHW. When the "comfort" icon is on, the function is enabled. When it is off the function is disabled and the boiler is in standard DHW operating mode for an instant boiler. For KR/KRB models with CH only, the "comfort" function is not available and thus the word "COMFORT" is always disabled on the display.

If "comfort" function is enabled ("comfort"), press "OK" button to disable it.

If "comfort" function is disabled ("comfort" icon OFF), press "OK" button to enable it.

1. "Comfort" function enabled
2. Press **OK**

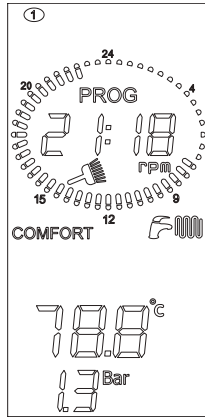

3. "Comfort" function disabled

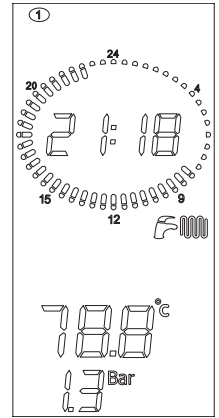

1.6 Time setting

1. To set time, minutes and day of the week, press .

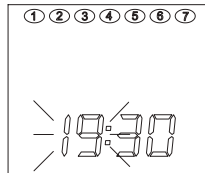

2. Flashing values can be edited by pressing **CH +/-** buttons. The first value to be modified is "HOURS".

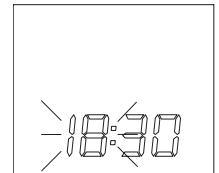

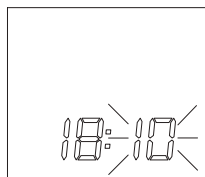

3. Press **OK** to confirm the edited values and shift to next parameter. The second value to be modified is "MINUTES". Flashing values can be edited by pressing **CH +/-** buttons.

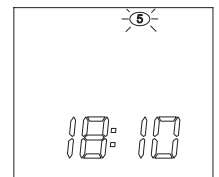

4. Press **OK** to confirm the edited values and shift to next parameter. The third value to be modified is "DAYS". Day of the week can be selected by pressing **CH +/-** buttons.



5. Press **OK** to confirm the edited values. Press  to access the day and night setting function described in the following paragraph. Press  to quit the function and go back to starting page.

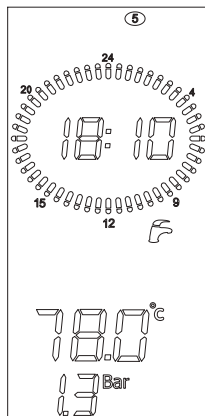

1.7 "Day temperature" and "night temperature" setting

When one or more ambient probes are connected to boiler electronic board, two levels of desired ambient temperatures can be set. Boiler will manage the heating request based on the set temperatures, as follows.
 If no ambient probe is connected to the boiler, temperatures cannot be set.

"Day" temperature is identified by the symbol ☀, while "night" temperature by the symbol 🌙.

The "day temperature" is active when bars are on, while "night" temperature is active when bars are off.

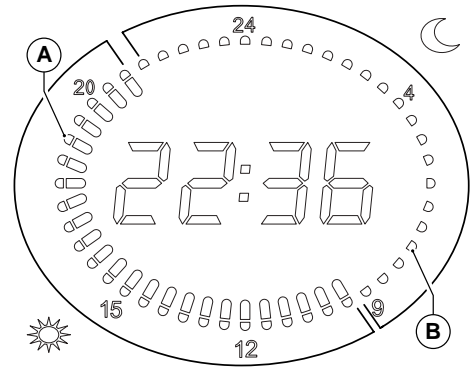

A bars on
 B bars off

1. Press  twice to access the "day temperature" setting mode.

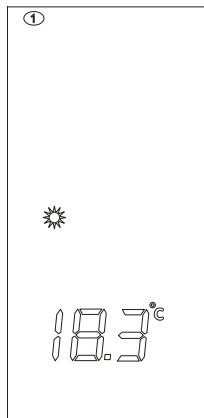

2. Press **CH +/-** buttons to edit "day temperature" values.

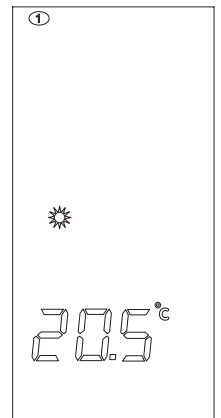

3. Press **OK** to confirm the edited values and enter the "night temperature" setting mode.

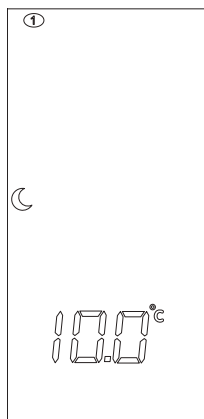

4. Press **CH +/-** buttons to edit "night temperature" values.

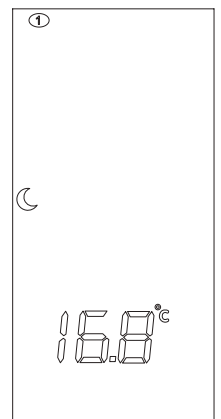

5. Press **OK** to confirm the edited values and quit the setting mode.

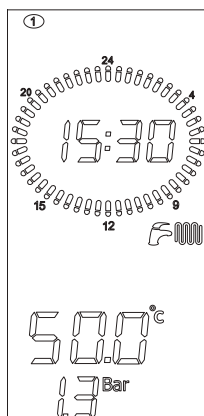

1.8 "Manual" programme setting

The "manual" mode selection indicated with symbol , allows activating the heating function, 24 hours a day, in both zones at the "day temperature", disabling at the same time zone 1 and zone 2 programming.

External water heater, if there is one, is heated according to the specific programme.

1. Press  to access the manual programme setting mode.



2. Press **OK** to confirm.

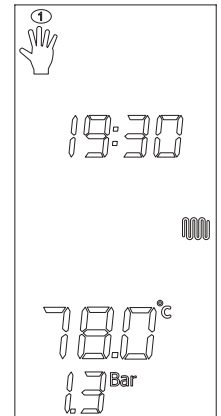

3. Press  to go back to the starting page, namely to quit the function.

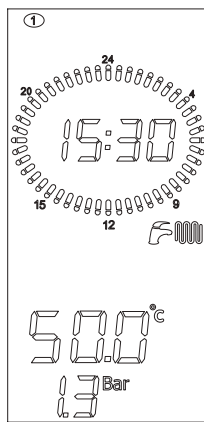

1.9 "Automatic" programme setting

The selection of "automatic" mode, identified by symbol , allows boiler to enable heating of both zones in "day temperature" or "night temperature", based on the programming envisaged for zone 1 and zone 2.

1. Press **PROG** twice to access the automatic programme setting mode.

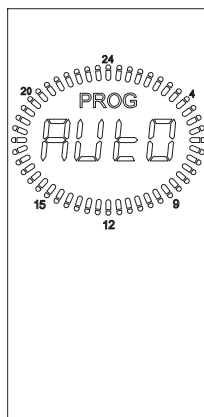

2. Press **OK** to confirm.

3. Press  to go back to the starting page, namely to quit the function.

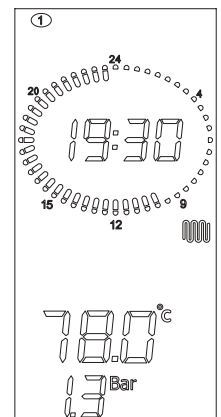

1.10 CH programme mode

To access zone 1 heating programme displaying or editing, press **PROG** button twice.

1. The display shows zone 1 symbol flashing, sun or moon symbols, bars on or off, respectively, at 00:00. Clock lights display the programming connected to day 1 (Monday) and 00:00 bar is flashing.

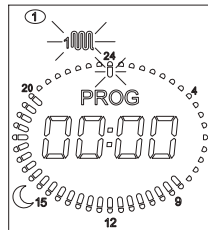



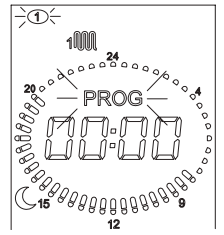

2. Press **OK** to access zone programming function. "PROG" wording starts flashing together with number 1 (Monday).

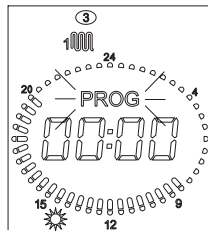

3. The required day can be selected by pressing **CH +/-** buttons.
4. Press **OK** to select the desired day.
5. Now you can associate the day/night level to the desired time of the day.



6. Whenever  /  button is pressed, the sun and moon symbols are alternatively activated (sun = day level; moon = night level).
7. At the same time, close to the current time (flashing bar) clock bar comes on if the  icon is on, and turns off if the  icon is off.
8. Current time is indicated by both the clock and the flashing bar.
9. Press **CH +/-** buttons to move inside the different times of the day.

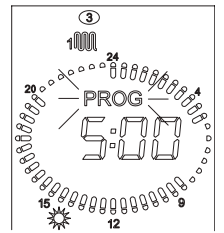

10. To program other days of the week or to program zone 2 and water heater, press **Reset**.
11. You will go back to the starting page.

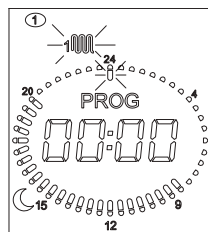



Whatever part of the programme can be quit by pressing the **Reset** button twice.

The procedure to program zone 2 and water heater, is very similar to the one followed to program zone 1.

Press the "prog" button to access, in sequence, to the following 4 programmes: manual; zone 1; zone 2; water heater.

If ambient probes are connected, the "day temperature" and the "night temperature" levels will acquire the temperature value, and heating will be active until the temperature measured by the ambient probe reaches the preset value for the different time slots.

When no ambient probe is connected, the two day/night levels will acquire the on and off values.

Heating is ON in the selected periods with the  icon, while it is OFF in the selected periods with the  icon.

In case of connection with "Open Therm" Remote Control, that zone shall not be managed by boiler boards, as it will be directly managed by the remote control and, as a consequence, zone programming will be inhibited.

1.11 Parameter display

Press  to scroll the different parameter values.

You can quit this function at any time by simply pressing the  button.
To find the meaning of all parameters, see *TSP parameters* on page 62.

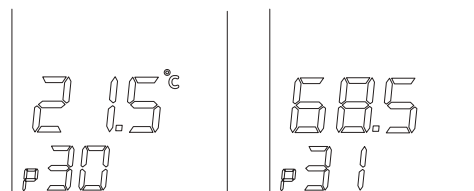

Par.	DESCRIPTION
P30 - TSP30	external temperature displayed (if an external probe is installed).
P31	Flow temperature is displayed.
P32	Calculated nominal flow temperature is displayed. If an external probe is not installed the flow temperature manually set on the boiler is displayed. If an external probe is installed the flow temperature automatically set by the boiler on the basis of the thermoregulation curves is displayed.
P42	DHW temperature (for KC model).
P42	Displaying of domestic hot water temperature .
P43	Boiler return temperature displaying.
P44	Water heater temperature displaying (for KR/KRB models with installed water heater probe). Cold water temperature (KC model only).
P45	Flue gas temperature displaying.
P46	Solar collector temperature is displayed (if optional solar collector probe is installed).
P47	Solar valve temperature display (if a solar valve is installed).
P48	Solar water heater temperature or solar valve temperature displaying (if the water heater probe or solar valve probe are installed on additional solar board).

Tab. 1 Displayable parameters with info button

1.12 Failures that cannot be reset

The display shows the failure based on the corresponding error code (see *Troubleshooting* on page 92).

Some failures can be reset through the  key, while some others are self-resettable (refer to the following paragraph).
If failures cannot be reset but are of the self-resettable type, no key will be enabled and only the LCD backlighting will be on.
As soon as the error cause is eliminated, the failure signal will disappear from the interface.
The interface is enabled and after 15 seconds is disabled, unless a button is pressed.

1.13 Resume boiler function

The display shows the failure based on the corresponding error code (see *Troubleshooting* on page 92).

Some failures can be reset through the  key, while some others are self-resettable.
If shut-downs can be reset (E01, E02, E03, E40, E80, E86, E87), the reset key and the LCD backlighting will always be on.

The only active key you can press is the  key.

When the reset key is pressed and boiler is under the correct conditions, the error is reset. The failure signal will disappear from the interface.

The interface is enabled and after 15 seconds is disabled, unless a button is pressed.

1.14 Boiler operation

1.14.1 Switching on



DANGER

It is presumed that the boiler has been installed by a qualified installer, it has been commissioned and is ready to operate correctly.

- Open the gas shut-off cock.
- Turn the master switch installed ahead of the boiler to ON.
- The display turns on and indicates the function currently active (see *Interpreting boiler status from display indications* on page 13).
- Select boiler operating mode by pressing  button on the touch-screen: OFF, SUMMER, WINTER, CH ONLY (see *Selecting the operating mode* on page 15).
- Set desired CH temperature (see *CH function* on page 21).
- Set the desired temperature value for domestic hot water (KC or KR/KRB models with optional external water heater) (see *DHW function* on page 22).
- If one or more ambient probes or a thermostat are present, set the desired ambient temperature value and the weekly programming.



WARNING

Should the boiler be left inactive for a long time, particularly when boiler is propane-fired, ignition might be difficult. Before starting the boiler switch on another gas powered device (e.g. kitchen range). Beware that even by following this procedure, the boiler might still experience some starting difficulties and shut down once or twice. Press the RESET button to restore boiler operation.

1.14.2 CH function

To set the water temperature for central heating, press the **+/- HEATING** buttons.

Heating temperature adjustment range depends on the selected operating range.:

- standard range: from 20°C to 78°C (pressing **CH +/-**);
- reduced range: from 20°C to 45°C (pressing **CH +/-**).

Operation range selection is to be implemented by a installer or an authorized Service Centre (see par. *Selecting the operating range in heating mode* on page 60).

During temperature setting, the  symbol flashes on the screen and the CH current temperature setting is displayed.

When the CH system requests heat from the boiler, the LCD displays the CH symbol  and the current CH flow water temperature.

The waiting time between one switching on of the boiler and another, in order to avoid the boiler coming on and off when in central heating mode, is between 0 and 10 minutes (4 by default), which can be changed with parameter **P11**.

Should water temperature in the system fall below set minimum value, between 20°C and 78°C (default value 30°C for standard range, 20°C for reduced range) to be edited with the **P27** parameter, the waiting time is reset and the boiler re-ignites.

The burner ON symbol  shows while the burner is operating.

1.14.3 DHW function

DHW production function is enabled on model KC and on KR/KRB models with external water heater (optional).

DHW production function is enabled in one of the following operating modes: SUMMER or WINTER.

Such function has always priority over CH water supply.

To set the domestic hot water temperature, press **DHW +/-** buttons.

During temperature setting, the  symbol flashes on the screen and the DHW current temperature setting is displayed.

Model KC

For KC model, DHW temperature may be set within a range from +35 °C to +57 °C.



WARNING

A flow limiter is installed within the boiler, which limits DHW output flow rate.

This limit value is: 10 litres per minute for KC 12 model; 13 litres per minute for KC 24 model, 14 litres per minute for KC 28 model, and 16 litres per minute for KC 32 model.

Models KR/KRB

On KR/KRB models with external water heater (optional) and water heater temperature probe (optional, supplied by the manufacturer; included in the standard supply for KRB model), temperature range is between 35 °C and 65 °C.

On KR/KRB models with external water heater (optional) and water heater probe (optional, supplied by the manufacturer), every 15 days the anti-legionella function will be enabled, consisting in raising the water heater temperature to 65°C for 30 minutes independent of other settings.

1.14.4 Comfort function (model KC only)

The COMFORT function keeps the plate heat exchanger hot, to minimise the waiting time for the production of DHW.

Enable COMFORT function by pressing the corresponding button on the display (see *Comfort function enable/disable* on page 16).

1.14.5 Freeze protection function

This boiler is fitted with a freeze protection system, which works when the following functions are activated: OFF/SUMMER/WINTER/CH ONLY.



DANGER

The freeze protection function only protects the boiler, not the whole heating system.

The central heating system can be effectively protected against icing by using specific anti-freeze products that are suitable for multi-metal systems.



WARNING

Do not use anti-freeze products for car engines, and check the effectiveness of the product used over time.

In case burner cannot be ignited due to the lack of gas, the freeze protection functions are anyway enabled through the circulation pumps.

1.14.5.1 Ambient probe freeze protection function

If the boiler board is OFF, or DHW ONLY, and the ambient probes detect a temperature below 5°C, a heating request to heat the probe-controlled room is launched.

The heating function ends when the probe ambient temperature reading reaches +6°C.

1.14.5.2 Flow freeze protection function

When the heating water temperature sensor detects a water temperature of +5 °C, the boiler switches on and stays on at its minimum heat output until the temperature reaches +30 °C or 15 minutes have elapsed.

The pump continues to operate even if the boiler shuts down.

1.14.5.3 Plate heat exchanger freeze protection (only model KC)

When the DHW temperature sensor detects a water temperature of +5°C, the boiler switches on and stays on at its minimum heat output until the DHW temperature reaches +10°C or 15 minutes have elapsed (the deviating valve is in the DHW position).

During the DHW freeze protection operation the temperature detected by the flow probe is constantly checked, and in case it reaches +60 °C the burner is switched off.

The burner is switched on again if the operation request in anti-freeze mode is still present and the flow temperature is below +60°C. The pump continues to operate even if the boiler shuts down.

1.14.5.4 Water heater freeze protection function (for models KR/KRB with external water heater).

The water cylinder probe measures the temperature of water in the cylinder. When this temperature is less than 5°C a water heater frost protection function begins: the circulating pump begins working and the burner is switched on.

In KR/KRB models featuring an external water heater (optional) for the production of DHW with a NTC type temperature sensor (10 kΩ @ β=3435; refer to water heater technical specifications) the antifreeze function also protects the water heater.

When water heater temperature sensor detects a water temperature of +5 °C, the boiler switches on and stays on at its minimum heating output until the temperature of the water in the heater reaches +10 °C or 15 minutes have elapsed.

The pump continues to operate even if the boiler shuts down.

During the water heater anti-freeze operation the temperature detected by the flow probe is constantly checked, and in case it reaches +60°C the burner is switched off.

The burner is switched on again if the operation request in anti-freeze mode is still present and the flow temperature is below +60°C.

1.14.6 Anti-seize function

If the boiler remains inactive and connected to the power mains, the circulation pump and the deviating valve (if any) will be shortly enabled every 24 hours so as to avoid any shut-down.

The same applies to the relay which can be freely programmed whenever this latter is used to power a recirculation pump or a deviating valve.

1.14.7 Operation with ambient probe

The boiler can be connected to sensor for room temperature measurement (supplied as standard).

Once the ambient temperature value is known, the boiler automatically regulates the heating water temperature, increasing it as the ambient temperature decreases and decreasing it when the ambient temperature gets close to the set temperature.

Heating water temperature varies based on a programme written inside boiler electronic microprocessor.

To set the desired ambient temperature, refer to paragraphs:

- "Day temperature" and "night temperature" setting on page 17.
- "Manual" programme setting on page 18.
- "Automatic" programme setting on page 18.
- CH programme mode on page 19.

To connect the ambient probe see *Room temperature installation* on page 60.



WARNING

Only original ambient temperature probes supplied by the manufacturer must be used.

The use of non-original ambient probes, not supplied by the manufacturer, may affect the operation of the ambient probe itself and of the boiler.

1.14.8 Operation with external probe (optional)

Boiler can be connected to a probe measuring the external temperature (optional - not compulsory, supplied by the manufacturer) Once the external temperature value is known, the boiler will automatically adjust the heating water temperature: increasing it as the external temperature decreases and decreasing it as the external temperature increases. This will both improve room comfort and reduce fuel consumption. Standard and reduced range max. temperature values will nevertheless be respected.

This boiler operating mode is called "sliding temperature operation".

Heating water temperature varies based on a programme written inside boiler electronic microprocessor.

With an external sensor, the **+/- HEATING** buttons no longer set the heating water temperature, and become buttons for changing the theoretical room temperature desired for the rooms to be heated.

During temperature setting, the fictitious ambient temperature  symbol flashes on the display and the value being set is shown.

For optimal curve adjustment, a position close to +20 °C is recommended.

For further details on "cruising temperature operation", refer to paragraph *Installation of the (optional) external probe and sliding temperature operation* on page 58.



WARNING

Only original external temperature probes supplied by the manufacturer must be used.

The use of non-original external probes, not supplied by the manufacturer, may affect the operation of the external probe itself and of the boiler.

1.14.9 Operation with (optional) remote control

The boiler can also be connected to a Remote Control (optional - not compulsory, supplied by the manufacturer) so as to manage several boiler parameters, such as:

- Boiler status selection.
- Ambient temperature selection.
- CH system water temperature selection.
- DHW temperature selection.
- CH system and (optional) external water heater activation time programming.
- Boiler diagnostics display.
- Boiler reset and other parameters.

To connect the Remote Control, see *Installation and operation with Open Therm Remote Control (optional)* on page 61.



WARNING

Only use original Remote Control Units supplied by the manufacturer.

The use of non-original remote controls, not supplied by the manufacturer, may affect Remote Control and boiler operation.

1.15 Boiler shut-down

The boiler shuts down automatically if a malfunction occurs.

To determine the possible causes of malfunction, see *Troubleshooting* on page 92.

Below is a list of shut-down types and the procedure to follow in each case.

1.15.1 Burner shut-down

Fault code **E01** is displayed flashing on the display in the event of burner shut-down due to missing flame.

If this happens, proceed as follows:

- check that the gas cock is open and light a kitchen gas ring for example to check the gas supply;
- once having checked if the fuel is available, press the  button to restore burner operation: if, after two starting attempts, the boiler still fails to start and enters the shut-down mode again, contact a service centre or qualified personnel for maintenance.



WARNING

If the burner shuts down frequently, there is a recurring malfunction, so contact a service centre or a qualified service engineer.

1.15.2 Shut-down due to incorrect air/flue gas system draught

The boiler is equipped with a safety device for flue gas exhaustion check.

Should an air/flue gas system malfunction occur, the control device will shut-down the boiler by interrupting the gas supply to the boiler and the LCD will display the code:

In this case, contact a Service Centre or a qualified service engineer to carry out the maintenance.

1.15.3 Shut-down due to low water pressure

1.15.3.1 KC model with automatic filling disabled (P94 = 0) and KR/KRB models

If "shutdown due to insufficient pressure in system" error **E04** starts flashing (indicating safety water pressure switch triggering), fill the system by opening the filler cock (see Fig. 2 Filler cocks).

E04 error is displayed when system pressure drops below 0.4 bar; error will be automatically reset as soon as system pressure reaches 1.0 bar.

Water pressure must be 1÷1.3 bars while the boiler is cold.

In order to restore water pressure, proceed as follows:

Turn filler cock anticlockwise **A** to fill the boiler with water.

Keep filler cock **A** open until the control panel shows a value of 1÷1.3 bar;

Shut the filler cock by turning the knob clockwise.

If the boiler still fails to operate, contact a Service Centre or a qualified service engineer.



DANGER

Make sure you close filler cock carefully after filling procedure is completed.

If the filler cock is not correctly closed, when the pressure increases, error E09 may be displayed and the heating system safety valve may activate and discharge water.

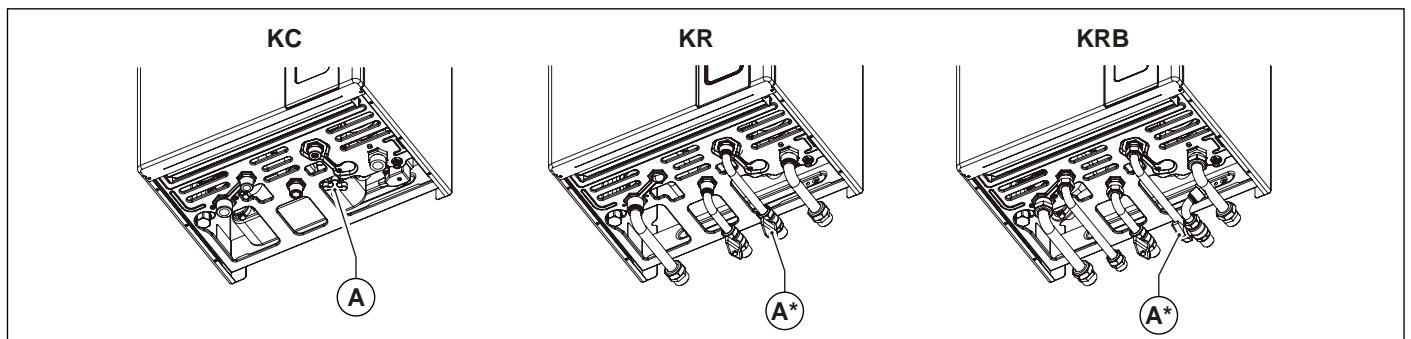

Fig. 2 Filler cocks

(*) optional

1.15.3.2 KC model with automatic filling enabled (P94 = 1)

In case the system pressure falls below 0.4 bar, the water pressure switch triggers and the display shows both fault code **E04** and the current pressure.

All buttons are disabled.



When automatic filling is activated, symbol  and pressure current value are displayed.

As soon as pressure reaches 1 bar, automatic filling will be completed, and display standard screen will appear again.

If, on the other hand, automatic filling cannot be successfully completed, error **E08** will occur (see *Shut-down due to incorrect filling procedure (KC, only)* on page 26).



1.15.4 Shut-down due to incorrect filling procedure (KC, only)

Error **E08** indicates that the automatic filling procedure has not been successfully completed.

Two cases are possible:

1. System pressure above 0.4 bar
2. System pressure below 0.4 bar

System pressure above 0.4 bar

When the **RESET** button is pressed, boiler is reset and display goes back to standard screen.

If the automatic filling occurs correctly the display shows the standard screen.

If automatic filling is not correctly carried out, error **E08** will be displayed again.



System pressure below 0.4 bar

Press the **RESET** button to activate the system automatic filling again, which will be signalled by the symbol  appearing on the display.

If the automatic filling occurs correctly the display shows the standard screen.

If automatic filling is not correctly carried out, error **E08** will be displayed again.



1.15.5 Alarm due to temperature probe malfunction

The following fault codes are shown on the display in the event of burner shut-down due to a temperature probe fault:

- **E05** for the CH probe: in this case the boiler does not work.
- **E06** for the DHW probe (KC model only); in this case the boiler works in heating mode only, whereas the DHW function is disabled.
- **E12** for DHW inlet probe (KC model only) and for external water heater probe (KR/KRB models). In this case, the boiler works in central heating mode only, and the DHW function is disabled.
- **E15** for the return probe; in this case the boiler does not work.
- **E44** for the ambient probe 1 (SA1); in this case the boiler does not work.
- **E45** for the ambient probe 2 (SA2); in this case the boiler does not work.



WARNING

In any case, contact a service centre or qualified personnel for maintenance.

1.15.6 Alarm due to (optional) external temperature probe malfunction

In case of external temperature probe failure, boiler will continue to operate, but the "sliding temperature" operation will be disabled. Heating water temperature is adjusted based on the value set with **CH +/-** buttons that, in this case, are no longer used to adjust calculated ambient temperature.

Contact a service centre or a qualified service engineer.

1.15.7 Alarm due to (optional) Remote Control connection malfunction

The boiler recognises whether or not there is a Remote Control (optional, not compulsory).

If the boiler does not receive information from the Remote Control after the Remote Control itself is connected, the boiler attempts to re-establish communication for 60 seconds, after which the fault code **E31** is shown on the remote control display.

The boiler will continue to operate according to the settings on the touch screen and ignore the Remote Control settings.



WARNING

Contact a service centre or a qualified service engineer to carry out the maintenance.

The remote control can indicate faults or shutdown conditions and can also restore boiler operation after shutdown up to a maximum of 3 times in a 24 hour period.

If the maximum number of attempts is reached, fault code **E99** is shown on the boiler display.

To reset error **E99**, disconnect and reconnect the boiler from the mains power.

1.15.8 Shut-down for fan malfunction

The fan operation is constantly monitored and in case of malfunction the burner goes off; the code **E40** flashes on the display.

This mode is maintained until the fan recovers normal working parameters.

If the boiler does not start and remains in this mode, contact a service centre or a qualified service engineer.

1.16 Maintenance



WARNING

The boiler must be serviced periodically as indicated in the relevant section of this manual.

Appropriate boiler maintenance ensures efficient operation, environment preservation, and safety for people, animals and objects.

Boilers must be maintained by qualified personnel only, under the requirements set forth by the prevailing rules.

1.17 Notes for the user



WARNING

The user may only clean the external casing of the boiler, employing common household products.

Do not use water!



WARNING

The user may only access parts of the boiler that can be reached without using special equipment or tools. The user is not authorised to remove the boiler casing or to operate on any internal parts.

No one, including qualified personnel, is authorised to modify the boiler.

The manufacturer shall not be held responsible in case of damage to people, animals, or property due to failure to follow the above mentioned instructions.

2. Technical features and dimensions

2.1 Technical features

This boiler is equipped with a fully pre-mixed gas burner. The following models are available:

- **KC** condensing boiler with sealed chamber and forced draught, supplying CH water and instant DHW production;
- **KR** condensing boiler with sealed chamber and forced draught, supplying CH water only.
- **KRB** condensing boiler with sealed chamber and forced draught, supplying CH water only; with 3-way deviating valve for connection to external water heater (optional).

The following power rates are available:

- **KC 12, KR 12, KRB 12:** with heat output 12,0 kW
- **KC 24, KR 24, KRB 24:** with heat output 23.7 kW
- **KC 28, KR 28, KRB 28:** with heat output 26,4 kW
- **KC 32, KR 32, KRB 32:** with heat output 30,4 kW

All models are equipped with electronic ignition and ionisation flame sensing device.

The boilers meet local applicable Directives enforced in the country of destination, which are stated on their rating plate.

Installation in any other country may be a source of danger for people, animals and property.

The key technical features of the boilers are listed below.

2.1.1 Manufacturing characteristics

- IPX5D electrically protected control panel.
- Integrated, modulating electronic safety board.
- Electronic start-up with built-in igniter and ionisation flame detection.
- Stainless steel, fully pre-mixed burner.
- Mono-thermal, high efficiency, composite and stainless steel heat exchanger with air purging device.
- Twin shutter modulating gas valve with constant air/gas ratio.
- Modulating, electronically managed combustion fan.
- High-efficiency CH circulation pump with built-in air purging device.
- Heating circuit pressure sensor.
- Heating flow water temperature probe (double).
- DHW temperature probe (KC).
- Flue gas thermostat on discharge tower
- Flue gas probe on primary heat exchanger.
- Integrated, automatic by-pass.
- 10 litre expansion vessel.
- System manual filler cock (CK).
- System manual discharge cock.
- Automatic filling solenoid valve (KC).
- DHW plate heat exchanger made of stainless steel (KC).
- Motorised 3-way valve (models KC and KRB).
- DHW flow meter (KC).
- DHW flow-limiting device - 10 litre/min (KC 12), 13 litre/min (KC 24), 14 l/min (KC 28) and 16 l/min (KC 32).

2.1.2 User interface

- Touch interface with built-in LCD to display and control boiler operating condition: OFF, WINTER, SUMMER and CH ONLY.
- CH water temperature regulator: 20-78 °C (standard range) or 20-45 °C (reduced range).
- DHW water temperature regulator: 35-57 °C (KC); 35-65 °C (KR/KRB with external water heater, optional).

2.1.3 Operating features

- CH electronic flame modulation with timer-controlled rising ramp (60 seconds, adjustable).
- DHW electronic flame modulation (models KC and KR/KRB with optional water heater).
- DHW priority function (model KC and models KR/KRB with optional water heater)
- Flow freeze protection function: ON 5°C; OFF 30°C or after 15 minutes of operation if CH temperature > 5 °C.
- DHW freeze protection function: ON 5°C; OFF 30°C or after 15 minutes of operation if CH temperature > 5 °C.
- Water heater freeze protection function (for models KR/KRB with optional external water heater and NTC probe): ON at 5 °C; OFF at 10 °C or after 15 minutes of operation if water heater temperature is > 5°C.
- Timer-controlled flue cleaning function: 15 minutes.
- Anti-legionella function (KR/KRB with optional water heater);
- CH Maximum heat input parameter adjustment.
- Ignition heat input adjustment parameter.
- Possibility to select the heating range: standard or reduced.
- Ignition flame propagation function.
- CH thermostat timer: 240 seconds (adjustable).
- Heating pump post-circulation function in CH, freeze protection and flue cleaning modes: 30 seconds (adjustable).
- DHW post-circulation function (KC and KR/KRB with optional water heater): 30 seconds.
- Post-circulation function for heating temperature > 78 °C: 30 seconds.
- Post-ventilation function after working: 10 seconds.
- Post-ventilation function for CH temperature >95 °C.
- Circulation pump and deviating valve anti shut-down function: 30 seconds of operation after 24 hours of inactivity.
- Ready for connection to an ambient thermostat.
- Ready for operation with an external probe (optional, supplied by the manufacturer).
- Ready for operation with an OpenTherm remote control (optional, supplied by the manufacturer).
- Ready for operation with a module for different temperature zones.
- Ready for integration with solar collectors.
- Ready for chronothermostat function on the boiler, in combination with two ambient probes.
- Anti water hammer function: adjustable from 0 to 3 seconds via parameter **P15**.

2.2 Dimensions

KC model

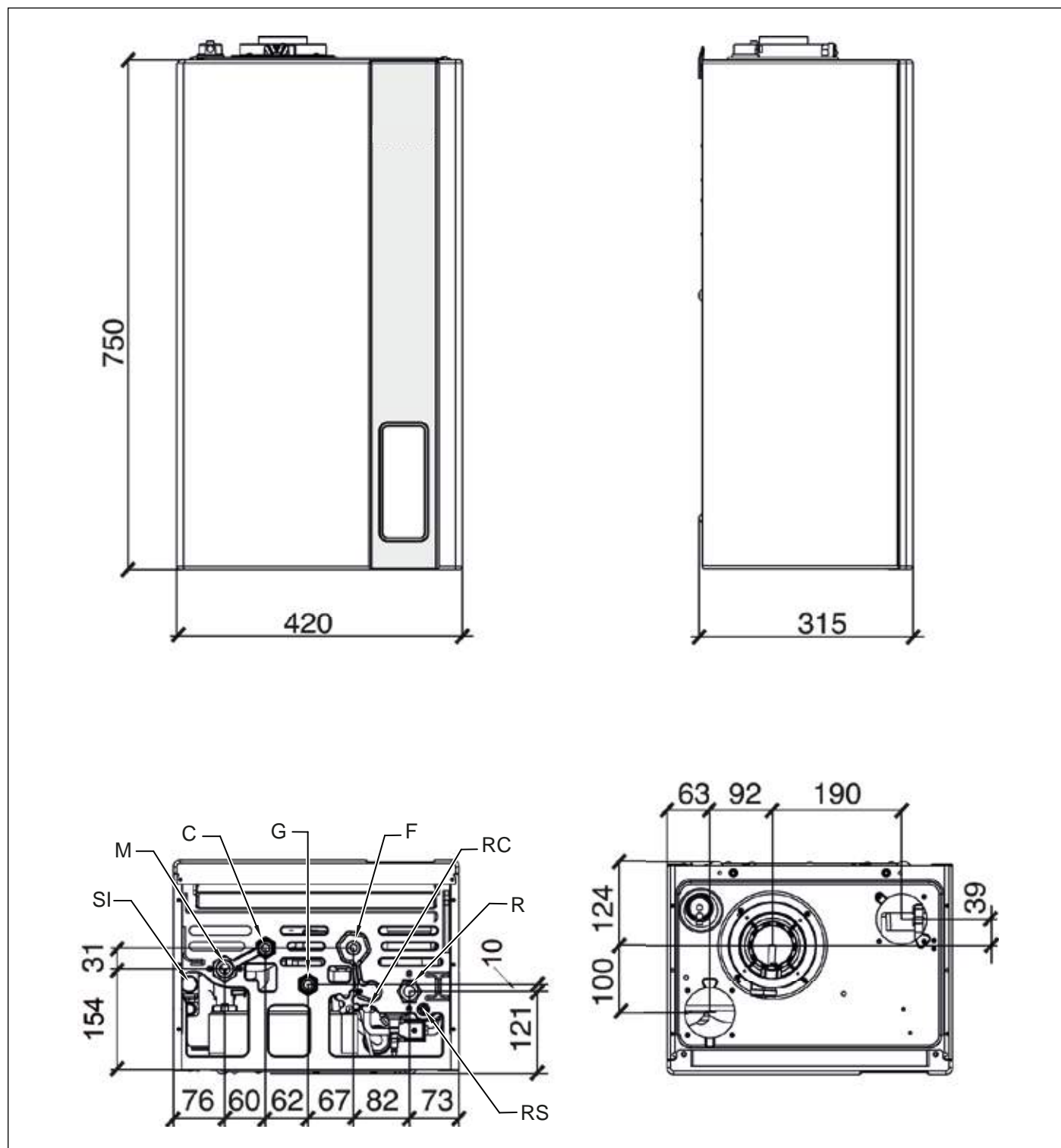

Fig. 3 Model KC dimensions

RUGIADA PLUS N CDX . . RUGIADA PLUS NB CDX

- M CH system flow (3/4")
- C DHW outlet (1/2")
- G Gas inlet (1/2")
- F Cold water inlet (1/2")
- RC Filler cock
- R CH system return (3/4")
- RS System unloading cock.

KR model

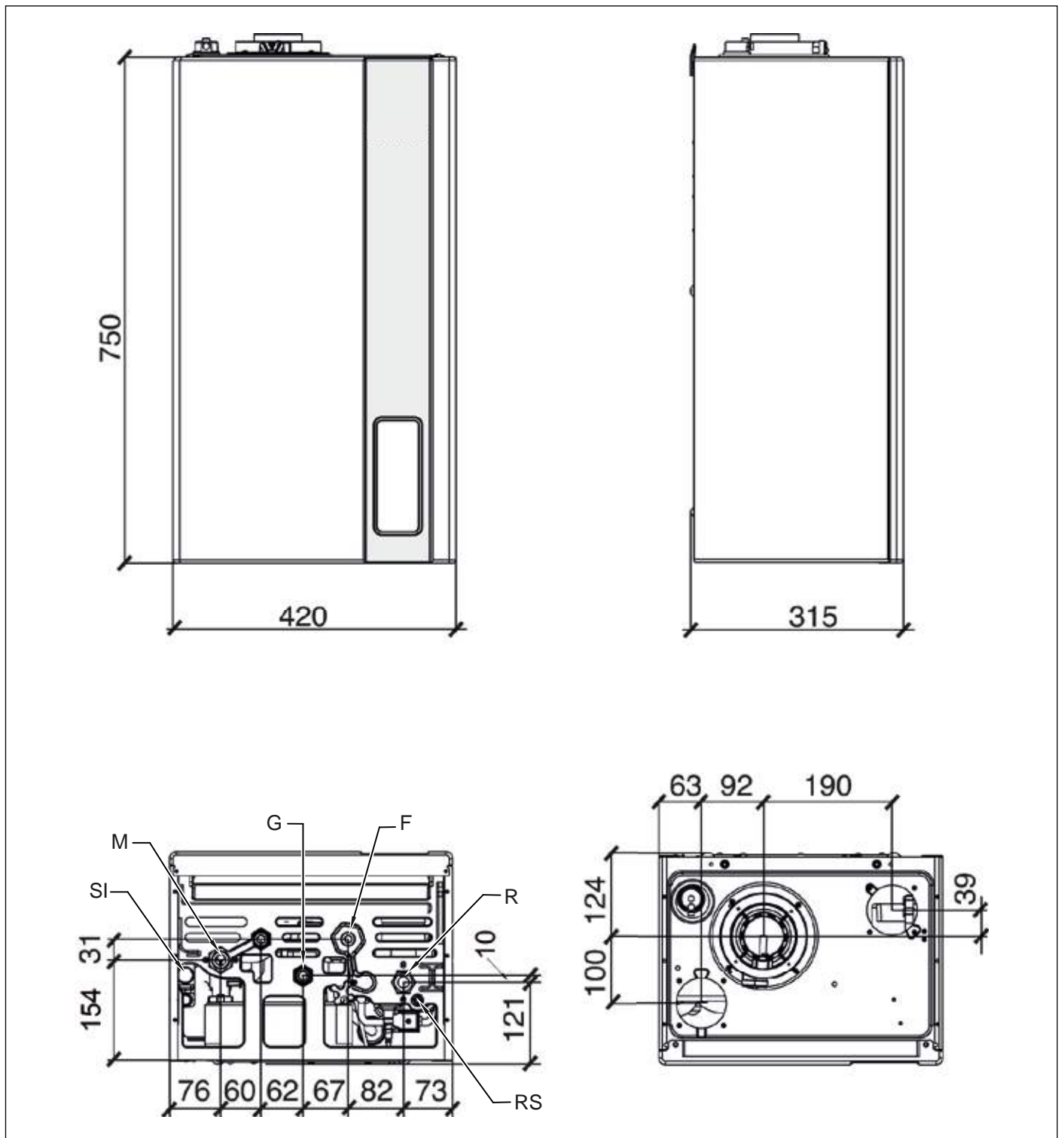

Fig. 4 Model KR dimensions

RUGIADA PLUS N CDX . . . RUGIADA PLUS NB CDX

- M CH system flow (3/4")
- G Gas inlet (1/2")
- F Cold water inlet (1/2")
- R CH system return (3/4")
- RS System unloading cock.

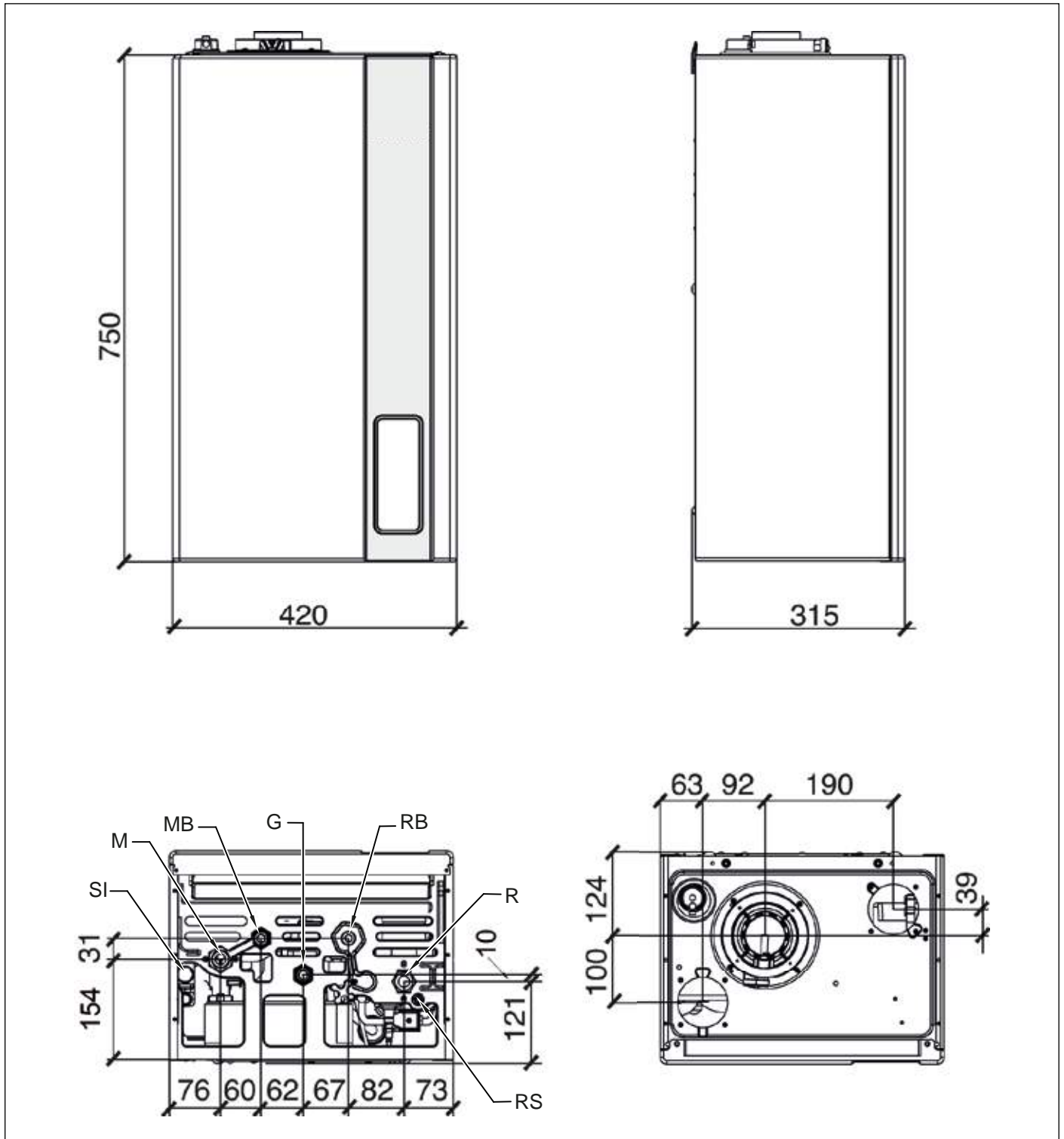

Fig. 5 Model KRB dimensions

RUGIADA PLUS N CDX . . RUGIADA PLUS NB CDX

- M CH system flow (3/4")
- MB Water heater secondary flow (1/2")
- G Gas inlet (1/2")
- RB Water heater secondary return (1/2")
- R CH system return (3/4")
- RS System unloading cock.

2.3 Boiler layouts

2.3.1 Model KC hydraulic layout

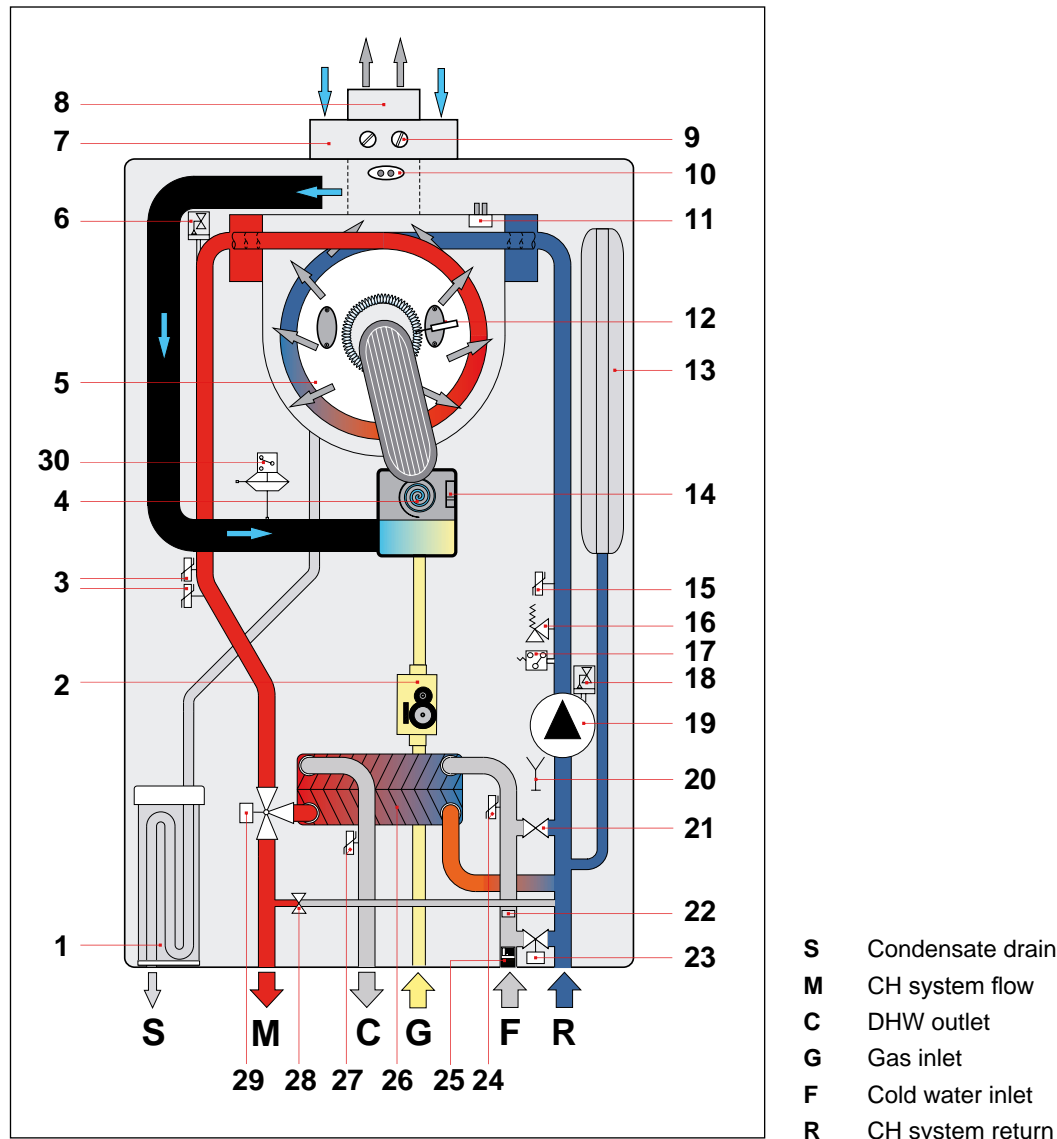

Fig. 6 Model KC hydraulic layout

- | | |
|---|---|
| 1. Condensate trap | 16. 3-bar safety valve |
| 2. Modulating gas valve | 17. Pressure transducer |
| 3. Flow temperature twin probe | 18. Air-purging device |
| 4. Modulating fan | 19. Modulating circulating pump |
| 5. Main condensing heat exchanger | 20. System unloading cock. |
| 6. Air-purging device | 21. Automatic filling solenoid valve |
| 7. Air intake duct | 22. DHW flow rate limiting device |
| 8. Flue gas venting duct | 23. Filler cock |
| 9. Flue gas analysis ports | 24. Cold water temperature probe |
| 10. Flue gas thermostat on venting duct | 25. Cold water flow meter with filter |
| 11. Flue gas probe on heat exchanger | 26. Insulated secondary plate exchanger |
| 12. Ignition/detection electrode | 27. DHW temperature probe |
| 13. Expansion vessel | 28. Automatic by-pass |
| 14. Fan check probe | 29. Motorised 3-way valve |
| 15. Return temperature probe | 30. Air pressure switch |

2.3.2 Model KR hydraulic layout

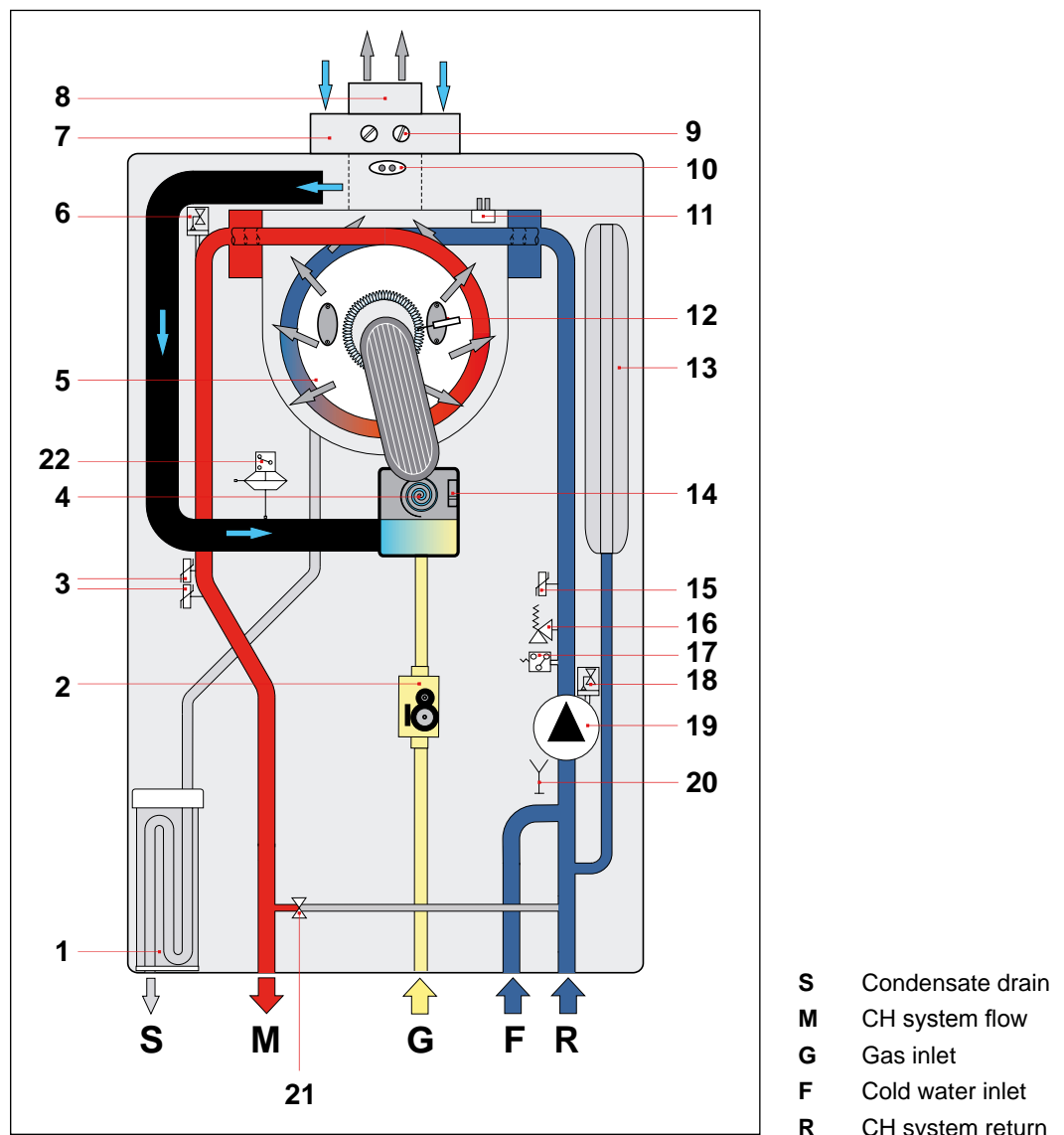

Fig. 7 Model KR hydraulic layout

- | | |
|---|----------------------------------|
| 1. Condensate trap | 12. Ignition/detection electrode |
| 2. Modulating gas valve | 13. Expansion vessel |
| 3. Flow temperature twin probe | 14. Fan check probe |
| 4. Modulating fan | 15. Return temperature probe |
| 5. Main condensing heat exchanger | 16. 3-bar safety valve |
| 6. Air-purging device | 17. Pressure transducer |
| 7. Air intake duct | 18. Air-purging device |
| 8. Flue gas venting duct | 19. Modulating circulating pump |
| 9. Flue gas analysis ports | 20. System unloading cock. |
| 10. Flue gas thermostat on venting duct | 21. Automatic by-pass |
| 11. Flue gas temperature probe on exchanger | 22. Air pressure switch |

2.3.3 Model KRB hydraulic layout

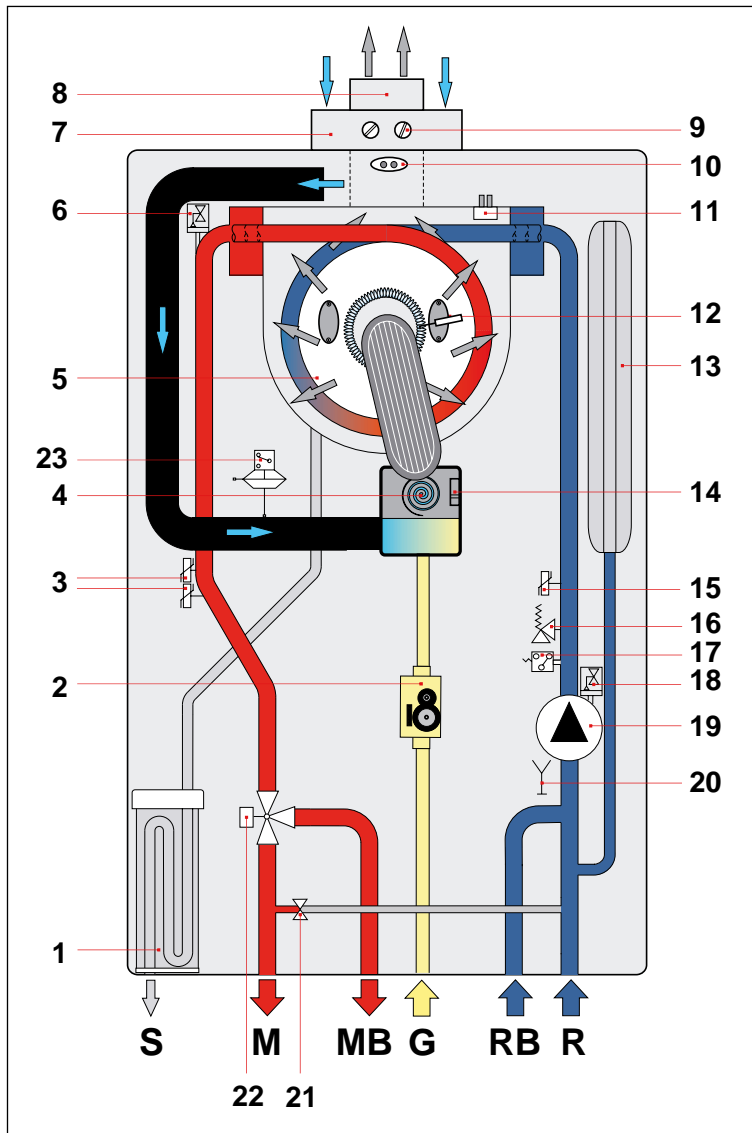

Fig. 8 Model KRB hydraulic layout

- | | |
|---|---------------------------------|
| 1. Condensate trap | 13. Expansion vessel |
| 2. Modulating gas valve | 14. Fan check probe |
| 3. Flow temperature twin probe | 15. Return temperature probe |
| 4. Modulating fan | 16. 3-bar safety valve |
| 5. Main condensing heat exchanger | 17. Pressure transducer |
| 6. Air-purging device | 18. Air-purging device |
| 7. Air intake duct | 19. Modulating circulating pump |
| 8. Flue gas venting duct | 20. System unloading cock. |
| 9. Flue gas analysis ports | 21. Automatic by-pass |
| 10. Flue gas thermostat on venting duct | 22. Motorised 3-way valve |
| 11. Flue gas probe on heat exchanger | 23. Air pressure switch |
| 12. Ignition/detection electrode | |

2.4 Operating data

Burner pressures reported in the following page must be verified after the boiler has been operating for 3 minutes.

Gas category: II2H3P

Fuel	Gas mains pressure [mbar]	Nozzle [mm]	Diaphragm diameter [mm]	Flue CO ₂ value Max. output ⁽¹⁾ [%]	Flue CO ₂ value Min. output [%]
Natural gas G20	20	3,05	-	9.0 ± 0.3	9,3 ± 0,3
Propane Gas G31	37	2,50	-	10.0 ± 0.3	10.3 ± 0.3

Tab. 2 Adjustment specifications KC-KR-KRB 12

Fuel	Gas mains pressure [mbar]	Nozzle [mm]	Diaphragm diameter [mm]	Flue CO ₂ value Max. output ⁽¹⁾ [%]	Flue CO ₂ value Min. output [%]
Natural gas G20	20	3,70	-	9.0 ± 0.3	9,3 ± 0,3
Propane Gas G31	37	3,00	-	10.0 ± 0.3	10.0 ± 0.3

Tab. 3 Adjustment specifications KC-KR-KRB 24

Fuel	Gas mains pressure [mbar]	Nozzle [mm]	Diaphragm diameter [mm]	Flue CO ₂ value Max. output ⁽¹⁾ [%]	Flue CO ₂ value Min. output [%]
Natural gas G20	20	4,00	-	9.0 ± 0.3	9,3 ± 0,3
Propane Gas G31	37	3,30	-	10.0 ± 0.3	10.3 ± 0.3

Tab. 4 Adjustment specifications KC-KR-KRB 28

Fuel	Gas mains pressure [mbar]	Nozzle [mm]	Diaphragm diameter [mm]	Flue CO ₂ value Max. output ⁽¹⁾ [%]	Flue CO ₂ value Min. output [%]
Natural gas G20	20	4,45	-	9.0 ± 0.3	9,3 ± 0,3
Propane Gas G31	37	3,55	7,2	10.0 ± 0.3	10.0 ± 0.3

Tab. 5 Adjustment specifications KC-KR-KRB 32

(1) DHW maximum heat input

2.5 General characteristics

Description	um	KC 12	KC 24	KC 28	KC 32
CH nominal heat input	kW	12,0	23,7	26,4	30,4
Minimum heat input	kW	2,0	3,0	3,3	4,2
Maximum heat output (80-60°C) - CH	kW	11,7	23,0	25,5	29,4
Minimum heat output (80-60°C) - CH	kW	1,8	2,6	3,0	3,9
Maximum heat output (50-30°C) - CH	kW	12,6	25,0	27,9	32,3
Minimum heat output (50-30°C) - CH	kW	2,1	3,2	3,5	4,4
Minimum CH system pressure	bar	0,5	0,5	0,5	0,5
Maximum CH system pressure	bar	3,0	3,0	3,0	3,0
DHW maximum heat input	kW	18,0	27,3	30,4	34,5
DHW minimum heat input	kW	2,0	3,0	3,3	4,2
DHW circuit min. pressure	bar	0,5	0,5	0,5	0,5
DHW circuit max. pressure	bar	6,0	6,0	6,0	6,0
DHW specific flow rate ($\Delta T=25K$)	l/min	10,6	16,1	18,6	19,4
DHW specific flow rate ($\Delta T=30K$)	l/min	8,8	13,4	15,5	16,2
Qualification of domestic hot water - EN 13203-1	-	★★★	★★★	★★★	★★★
Electric power supply – voltage / frequency	V - Hz	230 - 50	230 - 50	230 - 50	230 - 50
Power mains supply fuse	A	3,15	3,15	3,15	3,15
Maximum power consumption	W	88	97	101	106
Pump absorption	W	50	50	50	50
Electric protection rating	IP	X5D	X5D	X5D	X5D
Net weight	kg	32,0	34,5	35,5	37,0
Natural gas consumption at maximum CH output (Value referred to 15 °C - 1013 mbar)	cu. m/h	1,27	2,51	2,79	3,22
Propane gas consumption at maximum CH output	kg/h	0,93	1,84	2,05	2,36
Maximum CH working temperature	°C	83	83	83	83
Maximum DHW working temperature	°C	62	62	62	62
Total capacity of expansion vessel	l	10	10	10	10
Maximum recommended system capacity (Maximum water temperature 83°C, expansion vessel pressure 1 bar)	l	200	200	200	200

Tab. 6 General specifications KC models

Description	um	KR 12 KRB 12	KR 24 KRB 24	KR 28 KRB 28	KR 32 KRB 32
CH nominal heat input	kW	12,0	23,7	26,4	30,4
Minimum heat input	kW	2,0	3,0	3,3	4,2
Maximum heat output (80-60°C) - CH	kW	11,7	23,0	25,5	29,4
Minimum heat output (80-60°C) - CH	kW	1,8	2,6	3,0	3,9
Maximum heat output (50-30°C) - CH	kW	12,6	25,0	27,9	32,3
Minimum heat output (50-30°C) - CH	kW	2,1	3,2	3,5	4,4
Minimum CH system pressure	bar	0,5	0,5	0,5	0,5
Maximum CH system pressure	bar	3,0	3,0	3,0	3,0
DHW maximum heat input (*)	kW	18,0	27,3	30,4	34,5
DHW minimum heat input (*)	kW	2,0	3,0	3,3	4,2
Electric power supply – voltage / frequency	V - Hz	230 - 50	230 - 50	230 - 50	230 - 50
Power mains supply fuse	A	3,15	3,15	3,15	3,15
Maximum power consumption	W	88	97	101	106
Pump absorption	W	50	50	50	50
Electric protection rating	IP	X5D	X5D	X5D	X5D
Net weight	kg	32,0	34,5	35,5	37,0
Natural gas consumption at maximum CH output (Value referred to 15 °C - 1013 mbar)	cu. m/h	1,27	2,51	2,79	3,22
Propane gas consumption at maximum CH output	kg/h	0,93	1,84	2,05	2,36
Maximum CH working temperature	°C	83	83	83	83
Maximum DHW working temperature (**)	°C	62	62	62	62
Total capacity of expansion vessel	l	10	10	10	10
Maximum recommended system capacity (Maximum water temperature 83°C, expansion vessel pressure 1 bar)	l	200	200	200	200

Tab. 7 General specifications KR/KRB models

(*) Models KR/KRB with optional water heater.

(**) Models KR/KRB with water heater probe, option.

Description	um	Max. output	Min. output	30% load
Casing heat loss with burner on	%	0,40	7,85	-
Casing heat loss with burner off	%	0,53		
Flue system heat loss with burner on	%	2,50	1,85	-
Flue system mass capacity	g/s	8,25	0,89	-
Flue temp. – air temp.	°C	57,9	34,5	-
Heat output efficiency rating (60/80°C)	%	97,1	90,3	-
Heat output efficiency rating (30/50°C)	%	105,1	105,0	106,0
NOx emission class	-	6		

Tab. 8 Combustion specifications KC-KR-KRB 12

Description	um	Max. output	Min. output	30% load
Casing heat loss with burner on	%	0,44	9,84	-
Casing heat loss with burner off	%	0,21		
Flue system heat loss with burner on	%	2,72	2,02	-
Flue system mass capacity	g/s	12,43	1,33	-
Flue temp. – air temp.	°C	61	33	-
Heat output efficiency rating (60/80°C)	%	96,8	88,1	-
Heat output efficiency rating (30/50°C)	%	105,6	106,9	107,4
NOx emission class	-	6		

Tab. 9 Combustion specifications KC-KR-KRB 24

Description	um	Max. output	Min. output	30% load
Casing heat loss with burner on	%	1,04	6,13	-
Casing heat loss with burner off	%	0,20		
Flue system heat loss with burner on	%	2,26	1,89	-
Flue system mass capacity	g/s	13,93	1,47	-
Flue temp. – air temp.	°C	60	45	-
Heat output efficiency rating (60/80°C)	%	96,7	92,0	-
Heat output efficiency rating (30/50°C)	%	106,0	105,6	-
30% heat output efficiency rating	%	-	-	107,4
NOx emission class	-	6		

Tab. 10 Combustion specifications KC-KR-KRB 28

Description	um	Max. output	Min. output	30% load
Casing heat loss with burner on	%	0,87	5,10	-
Casing heat loss with burner off	%	0,19		
Flue system heat loss with burner on	%	2,33	2,00	-
Flue system mass capacity	g/s	15,81	1,87	-
Flue temp. – air temp.	°C	60	40,5	-
Heat output efficiency rating (60/80°C)	%	96,8	92,9	-
Heat output efficiency rating (30/50°C)	%	106,2	104,8	-
30% heat output efficiency rating	%	-	-	108,3
NOx emission class	-	6		

Tab. 11 Combustion specifications KC-KR-KRB 32

Additional specifications (EN 15502-1)	um	Value
Maximum operating temperature of the combustion products	°C	110
Overheating temperature of the combustion products	°C	110
Installation type: C63 - Maximum air temperature on intake	°C	40
Installation type: C63 - Maximum flue gas recirculation at the terminal	%	10

Tab. 12 Additional specifications

2.6 ERP and Labelling data

Model(s): ITACA			KC 12	KC 24	KC 28	KC 32
Condensing boiler			yes	yes	yes	yes
Low-temperature (**) boiler			yes	yes	yes	yes
B ₁ boiler			no	no	no	no
Cogeneration space heater			no	no	no	no
Combination heater			yes	yes	yes	yes
Seasonal space heating energy efficiency class			A	A	A	A
Water heating energy efficiency class			A	A	A	A
Declared load profile			M	XL	XL	XXL
Item	Symbol	Value	Unit			
Rated heat output	P _{rated}	kW	12	23	26	29
Useful heat output: At rated heat output and high-temperature regime (*)	P ₄	kW	11,7	23,0	25,5	29,4
Useful heat output: At 30 % of rated heat output and low-temperature regime (**)	P ₁	kW	3,8	7,7	8,5	9,8
Seasonal space heating energy efficiency	η _s	%	90	92	92	93
Useful efficiency: At rated heat output and high-temperature regime (*)	η ₄	%	86,2	87,3	87,2	86,9
Useful efficiency: At 30 % of rated heat output and low-temperature regime (**)	η ₁	%	95,5	96,7	96,7	97,8
Auxiliary electricity consumption: At full load	e _{l,max}	kW	0,020	0,036	0,036	0,038
Auxiliary electricity consumption: At part load	e _{l,min}	kW	0,013	0,015	0,013	0,017
Auxiliary electricity consumption: In standby mode	P _{SB}	kW	0,003	0,003	0,003	0,003
Standby heat loss	P _{stby}	kW	0,064	0,049	0,054	0,059
Ignition burner power consumption	P _{ign}	kW	0,000	0,000	0,000	0,000
Annual energy consumption	Q _{HE}	GJ	21	41	45	52
Emissions of nitrogen oxides	NO _x	mg/kWh	26	29	27	34
Sound power level, indoors	L _{WA}	dBA	51	53	54	53
Water heating energy efficiency	η _{wh}	%	78 (1) 72 (2)	85 (1) 83 (2)	84 (1) 82 (2)	87 (1) 87 (2)
Daily electricity consumption	Q _{elec}	kWh	0,067 (1) 0,140 (2)	0,120 (1) 0,194 (2)	0,116 (1) 0,181 (2)	0,132 (1) 0,191 (2)
Annual electricity consumption	AEC	kWh	14 (1) 30 (2)	26 (1) 42 (2)	25 (1) 39 (2)	28 (1) 41 (2)
Daily fuel consumption	Q _{fuel}	kWh	7,350 (1) 9,690 (2)	22,140 (1) 27,870 (2)	22,290 (1) 28,060 (2)	27,870 (1) 35,030 (2)
Annual fuel consumption	AFC	GJ	6 (1) 7 (2)	17 (1) 21 (2)	17 (1) 21 (2)	21 (1) 27 (2)
Standby power consumption (solar device)	solstandby	W	0,08	0,08	0,08	0,08
Contact details: FONDITAL S.p.A. - Via Cerreto, 40 I-25079 VOBARNO (Brescia) Italia - Italy						
(*) High-temperature regime means 60 °C return temperature at heater inlet and 80 °C feed temperature at heater outlet.						
(**) Low temperature means for condensing boilers 30 °C, for low-temperature boilers 37 °C and for other heaters 50 °C return temperature (at heater inlet).						
(1) with COMFORT function disabled						
(2) with COMFORT function enabled						

Tab. 13 ERP and Labelling data - KC

Model(s): ITACA			KR 12 KRB 12	KR 24 KRB 24	KR 28 KRB 28	KR 32 KRB 32
Condensing boiler			yes	yes	yes	yes
Low-temperature (**) boiler			yes	yes	yes	yes
B ₁ boiler			no	no	no	no
Cogeneration space heater			no	no	no	no
Combination heater			no	no	no	no
Seasonal space heating energy efficiency class			A	A	A	A
Item	Symbol	Value	Unit			
Rated heat output	P _{rated}	kW	12	23	26	29
Useful heat output: At rated heat output and high-temperature regime (*)	P ₄	kW	11,7	23,0	25,5	29,4
Useful heat output: At 30 % of rated heat output and low-temperature regime (**)	P ₁	kW	3,8	7,7	8,5	9,8
Seasonal space heating energy efficiency	η _s	%	90	92	92	93
Useful efficiency: At rated heat output and high-temperature regime (*)	η ₄	%	86,2	87,3	87,2	86,9
Useful efficiency: At 30 % of rated heat output and low-temperature regime (**)	η ₁	%	95,5	96,7	96,7	97,8
Auxiliary electricity consumption: At full load	e _{l,max}	kW	0,020	0,036	0,036	0,038
Auxiliary electricity consumption: At part load	e _{l,min}	kW	0,013	0,015	0,013	0,017
Auxiliary electricity consumption: In standby mode	P _{sb}	kW	0,003	0,003	0,003	0,003
Standby heat loss	P _{stby}	kW	0,064	0,049	0,054	0,059
Ignition burner power consumption	P _{ign}	kW	0,000	0,000	0,000	0,000
Annual energy consumption	Q _{HE}	GJ	21	41	45	52
Emissions of nitrogen oxides	NO _x	mg/kWh	26	29	27	34
Sound power level, indoors	L _{WA}	dB(A)	51	53	54	53
Standby power consumption (solar device)	solstandby	W	0,08	0,08	0,08	0,08
Contact details: FONDITAL S.p.A. - Via Cerreto, 40 I-25079 VOBARNO (Brescia) Italia - Italy						
(*) High-temperature regime means 60 °C return temperature at heater inlet and 80 °C feed temperature at heater outlet.						
(**) Low temperature means for condensing boilers 30 °C, for low-temperature boilers 37 °C and for other heaters 50 °C return temperature (at heater inlet).						

Tab. 14 ERP and Labelling data - KR/KRB

3. Instructions for the installer

3.1 Installation standards

This boiler must be installed in compliance with the laws and standards in force in the country of installation, which are herein considered as entirely transcribed.

To find out about the gas category and technical specifications, refer to operation data and general features specified in the previous pages.



DANGER

**Accessories and spare parts for installation and service procedures are to be supplied by the Manufacturer.
Should non original accessories and spare parts be employed, boiler proper performance is not guaranteed.**

3.1.1 Packaging

Boiler is shipped in a sturdy cardboard box.

Remove boiler from cardboard box and check its integrity.

The packing materials can be recycled. Disposal must be managed via appropriate waste collection sites.

Keep packaging out of reach of children, as it may be dangerous.

The manufacturer shall not be held responsible in case of damage to people, animals, or property due to failure to follow the above mentioned instructions.

Packaging includes:

- a wall bracket:
- one temperature probe for water heater (KRB, only).
- a room temperature sensor.
- a bag containing:
 - » the present boiler installation, use and maintenance manual;
 - » the template for mounting the boiler on a wall (see Fig. 9 Paper template);
 - » 2 screws and relevant wall blocks for fixing the boiler to the wall;
 - » a corrugated pipe for condensate drain.

3.2 Choosing where to install the boiler

The following must be taken into account when choosing where to install the boiler:

- indications contained in paragraph *Air intake and flue gas venting system* on page 45 and its sub-paragraphs.
- check the wall for sturdiness, avoiding weak areas.
- do not install the boiler over appliances which may affect boiler operation (e.g. cookers, which produce steam and grease, washing machines etc.).
- do not install boilers in locations with a corrosive or very dusty atmosphere, such as hairdresser salons, laundries etc., as this may severely reduce the lifespan of the components of the boiler.
- avoid installing the air intake terminal in rooms or areas with corrosive or very dusty atmosphere to protect the heat exchanger.

3.3 Positioning the boiler

Each boiler is supplied with a paper template, found inside the packaging (see Fig. 9 Paper template).

The template allows you to ensure that the pipes connected to the CH system, the DHW system and the gas mains, and the air intake/flue gas venting ducts are all laid out correctly during the realisation of the water system and before installation of the boiler.

This template is made of heavy-duty paper and must be fixed, with the help of a level, onto the wall where the boiler is to be mounted.

The template provides all the indications required to drill the boiler mounting holes to the wall, procedure which is done using two screws and wall blocks.

The lower area of the template shows where to mark the exact point at which the couplings are to be positioned for boiler connection to the gas supply pipe, cold water mains supply pipe, hot water outlet, CH flow and return pipes.

The upper area of the template shows where air intake and flue gas ducts are to be positioned.

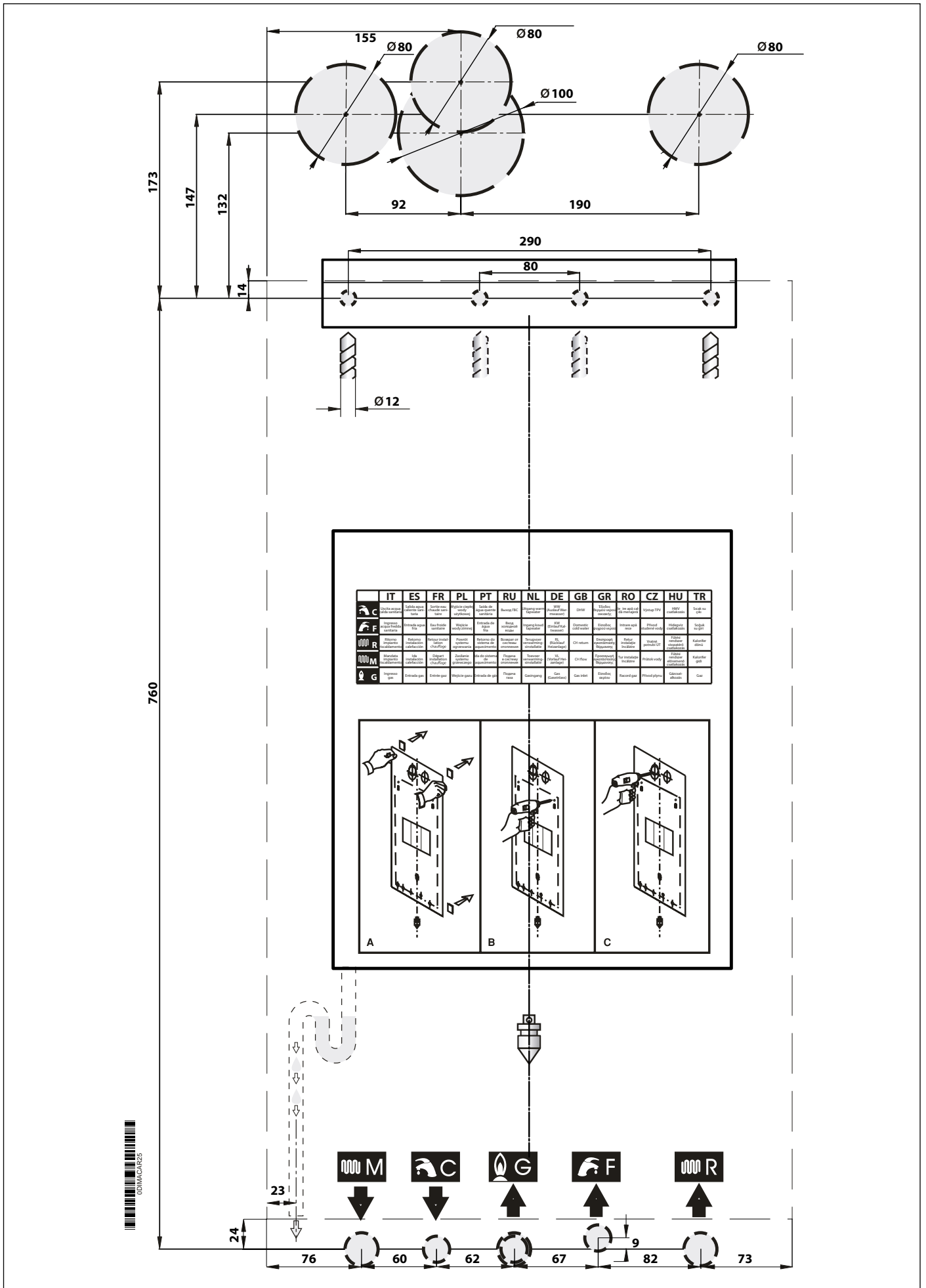

Fig. 9 Paper template

3.4 Installing the boiler



DANGER

Before connecting the boiler to CH and DHW networks, clean the pipes carefully.

Before commissioning a NEW system, clean it to remove any metal chips due to machining and welding, and any oil and grease that might negatively affect boiler operation or even damage it in case they get inside it.

Before commissioning a RECONDITIONED system (where radiators have been added, the boiler has been replaced, etc.) thoroughly clean it to remove any sludge and residues.

Clean the system using standard non acid products, available on the market.

Do not use solvents as they could damage system components.

Furthermore, in the central heating system (either new or reconditioned), it is always advisable to add to water a suitable percentage of corrosion protectants for multi-metal systems that will create a protective film onto all internal surfaces.

The manufacturer shall not be held responsible in case of damage to people, animals, or property due to failure to follow the above mentioned instructions.



WARNING

For all boiler installation types, it is necessary to install a filter which can be inspected (Y-shaped type) with Ø 0.4mm-mesh, on the return pipe before the boiler.

In order to install the boiler proceed as follows:

- Affix the template to the wall.
- Drill two Ø 12 mm holes in the wall to accommodate the boiler bracket wall blocks.
- If necessary, provide holes in the wall to allow air intake and/or flue gas venting ducts to pass through it.
- Secure the supporting bracket to the wall using the blocks supplied with the boiler.
- With reference to the lower part of the template, position the fittings for the connection of:
 - » gas supply pipe **G**;
 - » cold water supply pipe (KC/KR) or return from water heater (KRB) **F**;
 - » DHW outlet (KC) or flow to water heater (KRB) **C**;
 - » CH flow **M**;
 - » CH return **R**.
- Provide a condensate drain and an outlet for the 3-bar safety valve.
- Hook boiler to supporting bracket.
- Connect the boiler to mains pipes by means of the coupling kit supplied with the boiler (see *Hydraulic connections* on page 56).
- Connect the boiler to pipe for condensate drain (refer to *Hydraulic connections* on page 56).
- Connect the boiler to the air intake and flue gas venting system (see *Air intake and flue gas venting system* on page 45).
- Connect power supply, ambient thermostat (when available) and other available accessories (refer to the following paragraphs).

3.5 Boiler room ventilation

The boiler has sealed combustion chamber. Combustion air is not drawn from boiler room, therefore no specific recommendations need to be applied concerning the boiler room or openings and ventilation provided to the boiler room.



DANGER

the boiler must be installed in a room that is compliant with the legislation and standards in force in the country of installation, which are herein considered as entirely transcribed.

3.6 Air intake and flue gas venting system

Flue gas discharge into the atmosphere and air intake/flue gas venting systems must comply with applicable laws and standards in the country of installation that are considered as fully transcribed herein.



DANGER

For the air intake/flue gas venting systems, specific, manufacturer approved, condensate acid-resistant pipes and systems must be used, suitable for condensing boilers.



DANGER

In the case of passages through walls with split or coaxial air intake and gas venting ducts, always seal any space between pipes and walls.

If the wall is made of flammable material, apply fireproof insulating material around the flue gas venting pipe.



DANGER

For boilers with split air intake and flue gas venting ducts, in the case of passages through flammable walls, apply fireproof insulating material around the flue gas venting pipe.



DANGER

The boiler is equipped with a safety device for flue gas exhaustion check.

It is strictly forbidden to tamper with and/or prevent operation of such safety device.

Should an air/flue gas system malfunction occur, the device will shut-down the boiler by interrupting the gas supply to the boiler and the LCD will display the E03 code.

In this case it is necessary to have safety device, boiler and the air intake/flue gas venting ducts promptly checked by a service centre or a qualified service engineer.

After each operation on the safety device or the air suction/flue gas exhaust system, it is necessary to perform a functional test of the boiler.

In case it is necessary to replace the safety device use only original spare parts supplied by the Manufacturer.

3.6.1 Starter kit installation

Refer to Fig. 10 Split kit installation and to Fig. 11 Coaxial kit installation.



DANGER

There must be no leakage of combustion by-products from any of the gaskets.

Split kit (optional)

Clean the boiler roof from dust and other debris due to any masonry works.

Fix the adhesive gasket under the flange connection for flue gas venting system (A). The gasket must adhere completely to the whole surface.

Fix the flange connection for flue gas venting system (A) on the boiler roof at the suitable hole, using the screws supplied. The gasket must adhere completely to the roof surface.

Remove one of the two flue gas closing plugs (C) from the boiler top cover eliminating any seal residues.

Fix the adhesive gasket under the flange connection for air intake system (B). The gasket must adhere completely to the whole surface.

Fix the flange connection for air intake system (B) on the boiler roof at the suitable hole, using the screws supplied. The gasket must adhere completely to the roof surface.

Coaxial kit (optional)

Clean the boiler roof from dust and other debris due to any masonry works.

Fix the adhesive gasket under the flange coaxial connection (D). The gasket must adhere completely to the whole surface.

Fix the flange coaxial connection (D) at the suitable hole on the boiler roof, using the screws supplied. The gasket must adhere completely to the roof surface.

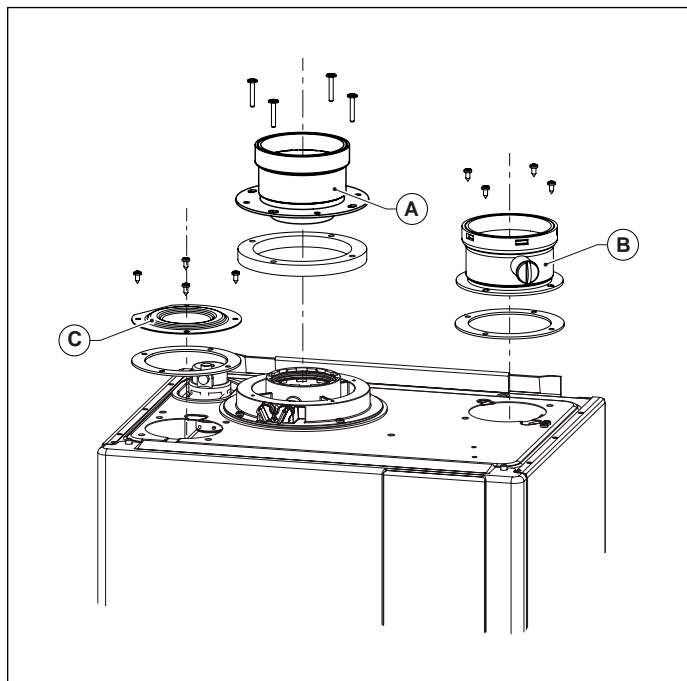

Fig. 10 Split kit installation

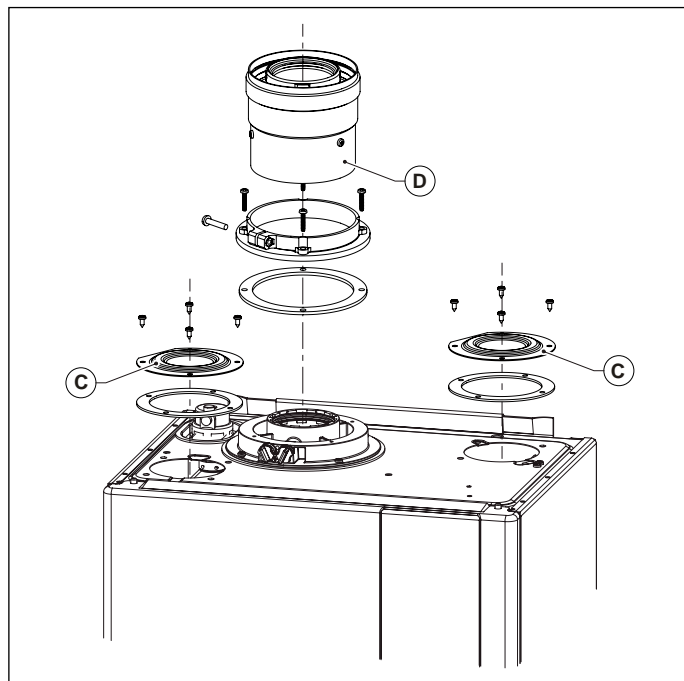

Fig. 11 Coaxial kit installation

3.6.2 Pipe and terminal installation



DANGER

Flue gas venting pipes are to be installed tilted toward the boiler so that condensate runs toward the combustion chamber, which is designed for condensate collection and drainage.

Should the above procedure not be possible, it is necessary to install, in condensate stagnation areas, devices designed for condensate collection and conveying to the condensate drain system.

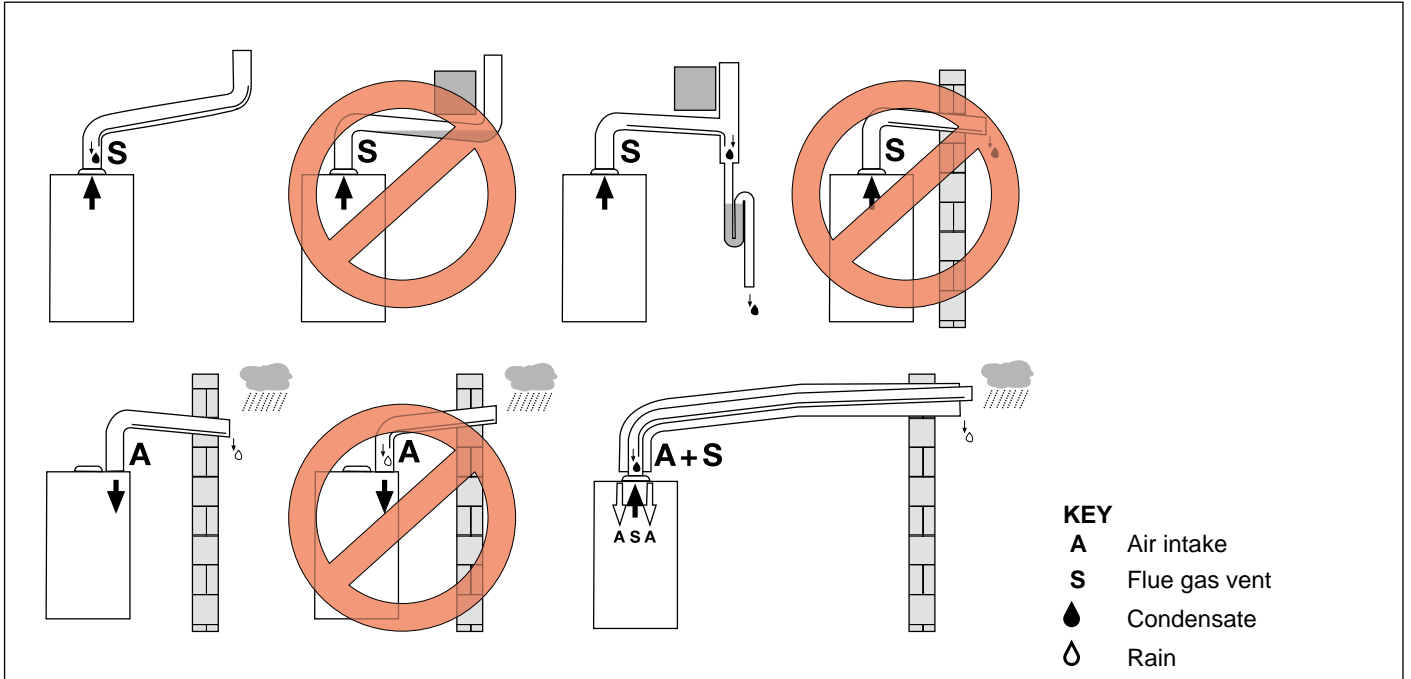

Fig. 12 Installation examples

To install pipes, bends, terminals and other accessories for air intake and flue gas venting, proceed as follows (see Fig. 13 Pipe installation):

- Clean surfaces and gaskets of the components, removing any dust and debris.
- Apply a thin layer of lubricant on the gasket.
- Insert the components with a slight rotation, pushing until the spigot end stops.



DANGER

There must be no leakage of combustion by-products from any of the gaskets.

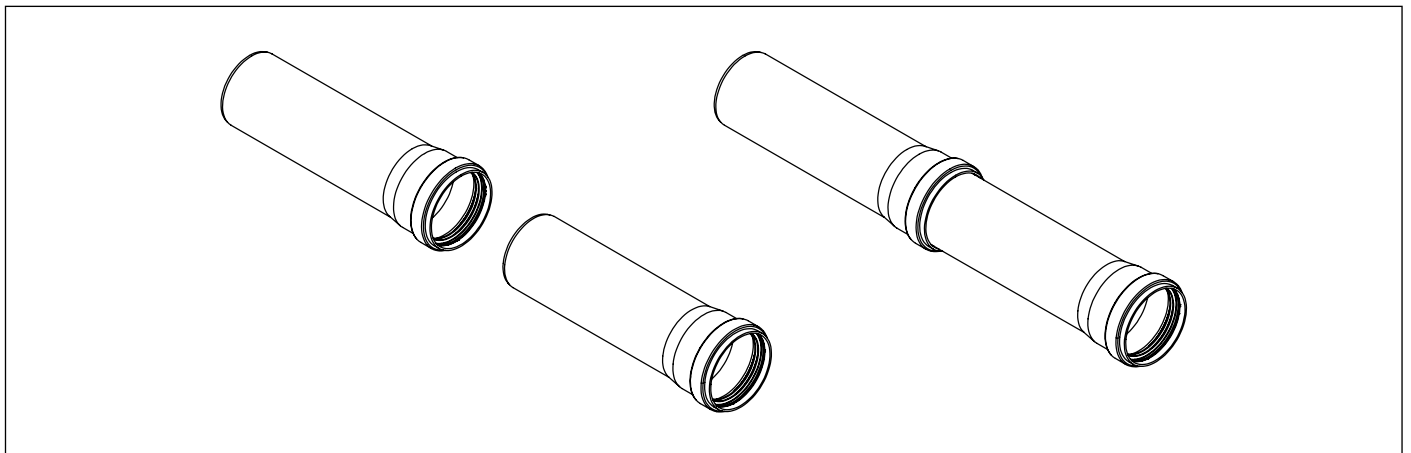

Fig. 13 Pipe installation

Wall-mounted terminals

The final parts of air intake and flue gas venting terminals, both split and coaxial, feature a groove (A) to fix the external collar (see Fig. 14 Wall-mounted terminal installation).

Insert the external collar into the terminal until reaching the groove.

Insert the terminal, from outside, making the external collar adhere to the wall. The terminal projection beyond the wall must be that imposed by the collar forced position.

Insert the internal collar, from inside, until it adheres to the wall.

Any pipes, bends or other components must not be inserted at the passage through the wall.

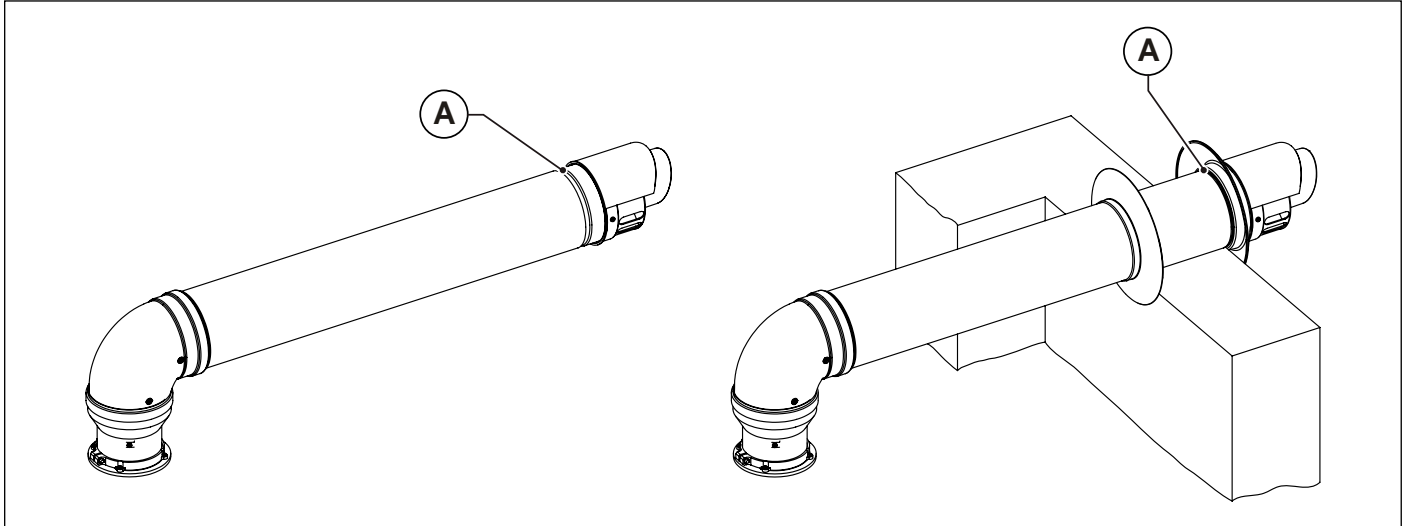

Fig. 14 Wall-mounted terminal installation

Tile for pitched roofs

The tile for pitched roofs can be used on roofs with an inclination between 18° and 44° (see Fig. 15 Tile for pitched roofs).

Remove the roofing elements (tiles, pantiles,...) from the roof area where the tile for pitched roofs will be installed.

Position the tile on the roof.

Position the roofing elements (tiles, pantiles,...) in such a way that rainwater drains over them.

Fit the cap (A) on the tile. The cap can be fitted in 2 positions, according to the roof inclination.

Insert the flue from above through the tile.

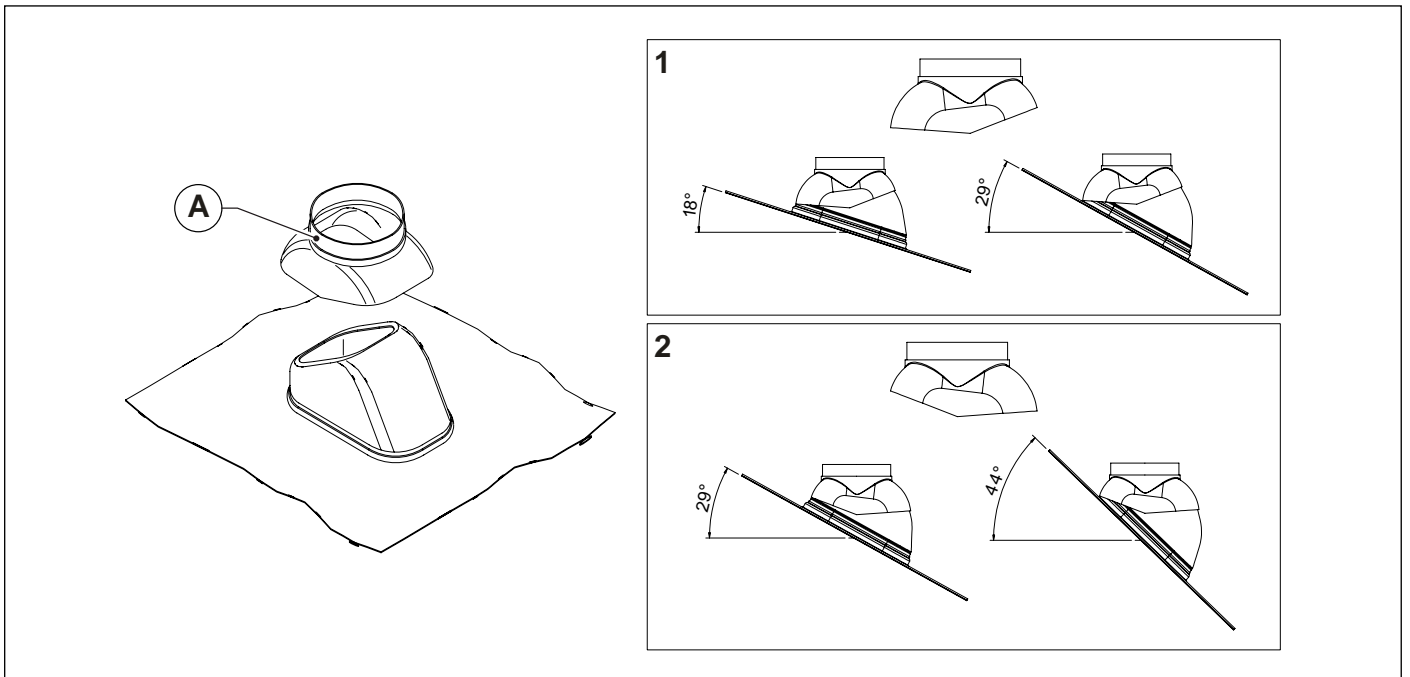

Fig. 15 Tile for pitched roofs

Roof flues

Insert the intake and/or flue gas venting flue from above through the tile.

Position the rainproof collar (A) until it bottoms on the cap of the tile for roofs (B) and fix it with the screw supplied.

Keep the distance indicated in the figure between the rainproof collar and the terminal.

Check that the flue is in a vertical position and fix it to the structure with collars or other fixing systems.

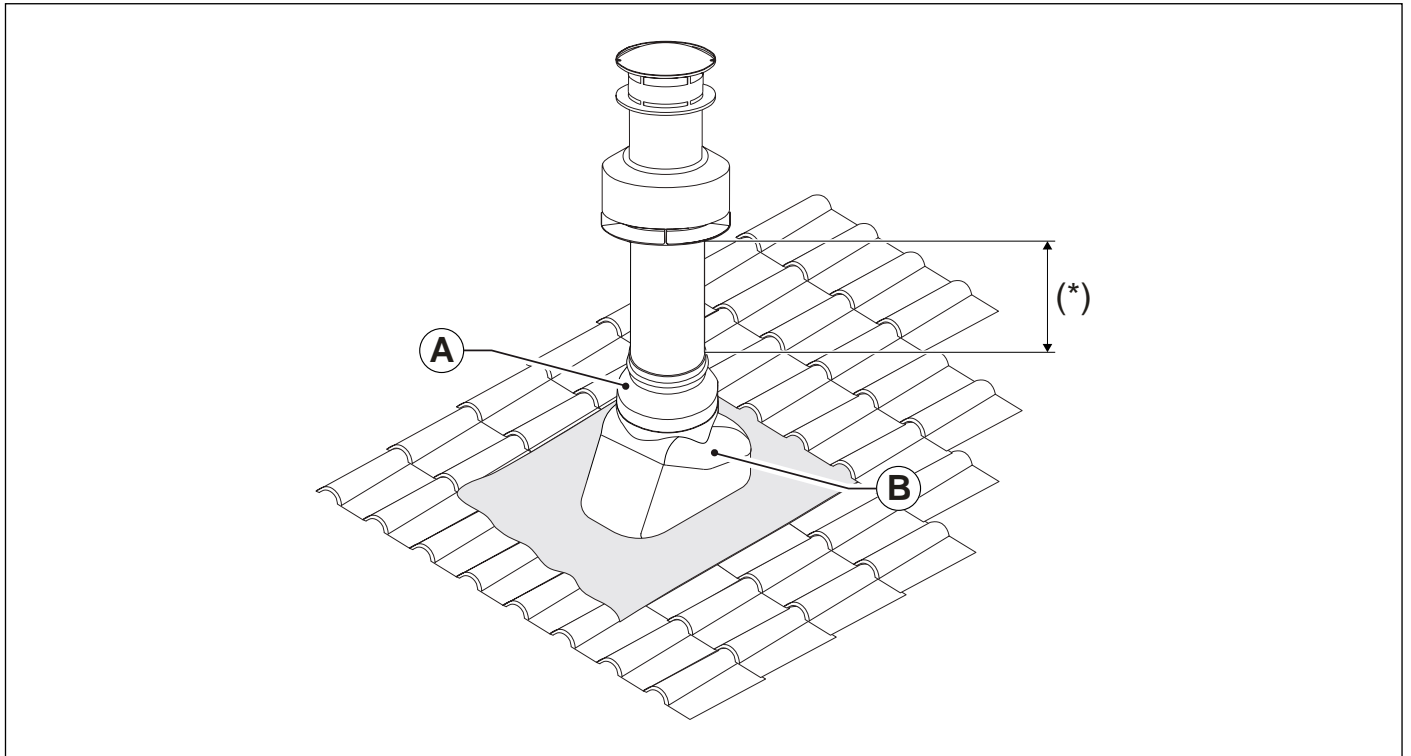

Fig. 16 Roof flue installation

- (*) ≥ 370 mm for 0CAMISCA00 and 0CAMIASP00 accessories.
- = 270 mm for 0KCAMASP00 accessory.

3.6.3 Possible configuration of air intake and flue gas venting ducts

Type B23/B23P

Boiler intended for connection to an existing flue system external to the boiler room.

Combustion air is taken directly from the boiler room itself while flue gas is conveyed to the outside.

The boiler is not to be fitted with anti-wind gust device; it has to be equipped with a fan mounted before the combustion chamber/heat exchanger.

Type C13/C13X

Boiler intended for connection to horizontal outlet and intake ducts connected to the outside by means of coaxial or split ducts.

The minimum distance between the air intake duct and the flue gas venting duct must be at least 250 mm, whereas both terminals must be contained within a square measuring 500 x 500 mm.

The boiler is to be equipped with a fan mounted before the combustion chamber/heat exchanger.

Type C33/C33X

Boiler intended for connection to vertical outlet and intake ducts connected to the outside by means of coaxial or split ducts.

The minimum distance between the air intake duct and the flue gas venting duct must be at least 250 mm, whereas both terminals must be contained within a square measuring 500 x 500 mm.

The boiler is to be equipped with a fan mounted before the combustion chamber/heat exchanger.

Type C43/C43X

Boiler intended for connection to collective chimney pipe system that includes two ducts, air intake and flue gas exhaustion. These ducts may be coaxial or split.

The chimney must be compliant with applicable legislation and standards.

The boiler is to be equipped with a fan mounted before the combustion chamber/heat exchanger.

Type C53

Boiler with separate pipes for combustion air intake and flue gas evacuation.

These flues may discharge in areas at a different pressure.

The terminals may not face each other from opposed walls.

The boiler is to be equipped with a fan mounted before the combustion chamber/heat exchanger.

Type C63

Boiler designed to be sold without air intake or flue gas venting ducts.

Flue gas venting and air intake to be ensured by using commercially available pipes, which are to be certified separately.

The boiler is to be equipped with a fan mounted before the combustion chamber/heat exchanger.

Type C83

Boiler intended to be connected to combustion air terminal and to a single flue gas terminal or collective chimney.

The chimney must be compliant with applicable legislation and standards.

The boiler is to be equipped with a fan mounted before the combustion chamber/heat exchanger.

3.6.4 Ø 100/60 mm and Ø 125/80 mm air/flue gas coaxial duct system



WARNING

The information given above is with reference to air intake/flue gas venting ducts made from smooth, rigid pipes approved and supplied by the manufacturer.

C13/C13X installation type

KC 12 - KR 12 - KRB 12

- Minimum permissible length of horizontal coaxial pipes is 1 meter.
- Maximum permissible length of Ø100/60 mm horizontal coaxial pipes is 9 meters, first curve included.
- Maximum permissible length of Ø 125/80 mm horizontal coaxial pipes is 30 meters including the first elbow connected to the boiler.
- For each additional 1 meter of straight pipe maximum permissible length is to be reduced by 1 meter.
- For each additional 90° elbow, maximum permissible length is to be reduced by 1 meter.
- For each additional 45° elbow, maximum permissible length is to be reduced by 0.5 meter.
- The wall terminal reduces maximum permissible length by 1.5 meters.
- The air intake duct is to be tilted down by 1% toward its exit, in order to avoid rain water to enter it.
- The flow resistance of the first elbow shall not be taken into account to calculate maximum permissible length.

KC 24 - KR 24 - KRB 24

- Minimum permissible length of horizontal coaxial pipes is 1 meter.
- Maximum permissible length of Ø 100/60 mm horizontal coaxial pipes is 10 meters including the first elbow connected to the boiler.
- Maximum permissible length of Ø 125/80 mm horizontal coaxial pipes is 30 meters including the first elbow connected to the boiler.
- For each additional 1 meter of straight pipe maximum permissible length is to be reduced by 1 meter.
- For each additional 90° elbow, maximum permissible length is to be reduced by 1 meter.
- For each additional 45° elbow, maximum permissible length is to be reduced by 0.5 meter.
- The wall terminal reduces maximum permissible length by 1.5 meters.
- The air intake duct is to be tilted down by 1% toward its exit, in order to avoid rain water to enter it.
- The flow resistance of the first elbow shall not be taken into account to calculate maximum permissible length.

KC 28 - KR 28 - KRB 28

- Minimum permissible length of horizontal coaxial pipes is 1 meter.
- Maximum permissible length of Ø100/60 mm horizontal coaxial pipes is 9 meters, first curve included.
- Maximum permissible length of Ø 125/80 mm horizontal coaxial pipes is 30 meters including the first elbow connected to the boiler.
- For each additional 1 meter of straight pipe maximum permissible length is to be reduced by 1 meter.
- For each additional 90° elbow, maximum permissible length is to be reduced by 1 meter.
- For each additional 45° elbow, maximum permissible length is to be reduced by 0.5 meter.
- The wall terminal reduces maximum permissible length by 1.5 meters.
- The air intake duct is to be tilted down by 1% toward its exit, in order to avoid rain water to enter it.
- The flow resistance of the first elbow shall not be taken into account to calculate maximum permissible length.

KC 32 - KR 32 - KRB 32

- Minimum permissible length of horizontal coaxial pipes is 1 meter.
- Maximum permissible length of Ø 100/60 mm horizontal coaxial pipes is 7 meters including the first elbow connected to the boiler.
- Maximum permissible length of Ø 125/80 mm horizontal coaxial pipes is 30 meters including the first elbow connected to the boiler.
- For each additional 1 meter of straight pipe maximum permissible length is to be reduced by 1 meter.
- For each additional 90° elbow, maximum permissible length is to be reduced by 1 meter.
- For each additional 45° elbow, maximum permissible length is to be reduced by 0.5 meter.
- The wall terminal reduces maximum permissible length by 1.5 meters.
- The air intake duct is to be tilted down by 1% toward its exit, in order to avoid rain water to enter it.
- The flow resistance of the first elbow shall not be taken into account to calculate maximum permissible length.

C33/C33X installation type

KC 12 - KR 12 - KRB 12

- Minimum permissible length of vertical coaxial pipes is 1 meter.
- Maximum permissible length of Ø 100/60 mm vertical coaxial pipes is 9 meters.
- Maximum permissible length of 125/80 mm vertical coaxial pipes is 30 meters.
- For each additional 1 meter of straight pipe maximum permissible length is to be reduced by 1 meter.
- For each additional 90° elbow, maximum permissible length is to be reduced by 1 meter.
- For each additional 45° elbow, maximum permissible length is to be reduced by 0.5 meter.
- The roof vent terminal reduces maximum permissible length by 1.5 meters.

KC 24 - KR 24 - KRB 24

- Minimum permissible length of vertical coaxial pipes is 1 meter.
- Maximum permissible length of Ø 100/60 mm vertical coaxial pipes is 10 meters.
- Maximum permissible length of 125/80 mm vertical coaxial pipes is 30 meters.
- For each additional 1 meter of straight pipe maximum permissible length is to be reduced by 1 meter.
- For each additional 90° elbow, maximum permissible length is to be reduced by 1 meter.
- For each additional 45° elbow, maximum permissible length is to be reduced by 0.5 meter.
- The roof vent terminal reduces maximum permissible length by 1.5 meters.

KC 28 - KR 28 - KRB 28

- Minimum permissible length of vertical coaxial pipes is 1 meter.
- Maximum permissible length of Ø 100/60 mm vertical coaxial pipes is 9 meters.
- Maximum permissible length of 125/80 mm vertical coaxial pipes is 30 meters.
- For each additional 1 meter of straight pipe maximum permissible length is to be reduced by 1 meter.
- For each additional 90° elbow, maximum permissible length is to be reduced by 1 meter.
- For each additional 45° elbow, maximum permissible length is to be reduced by 0.5 meter.
- The roof vent terminal reduces maximum permissible length by 1.5 meters.

KC 32 - KR 32 - KRB 32

- Minimum permissible length of vertical coaxial pipes is 1 meter.
- Maximum permissible length of Ø 100/60 mm vertical coaxial pipes is 7 meters.
- Maximum permissible length of 125/80 mm vertical coaxial pipes is 30 meters.
- For each additional 1 meter of straight pipe maximum permissible length is to be reduced by 1 meter.
- For each additional 90° elbow, maximum permissible length is to be reduced by 1 meter.
- For each additional 45° elbow, maximum permissible length is to be reduced by 0.5 meter.
- The roof vent terminal reduces maximum permissible length by 1.5 meters.

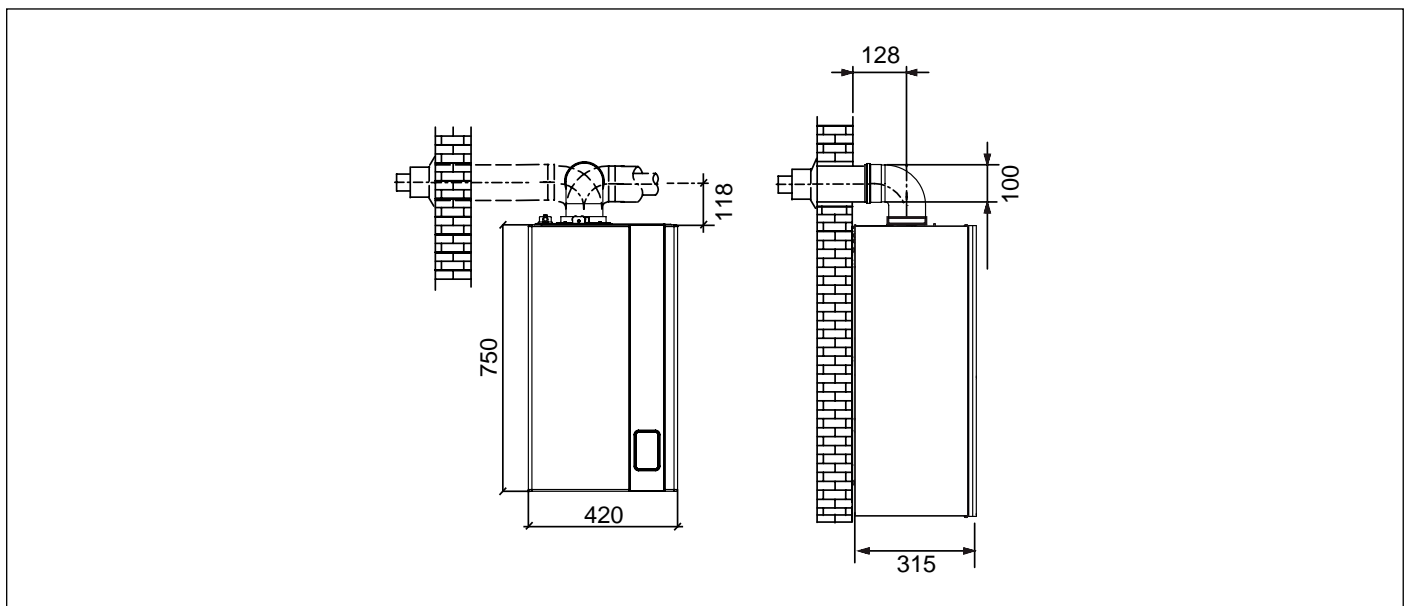

Fig. 17 Coaxial ducts C33 distance specs

3.6.5 Air intake and flue gas venting via 80 mm split pipes



WARNING

The information given above is with reference to air intake/flue gas venting ducts made from smooth, rigid pipes approved and supplied by the manufacturer.

Installation types C43/C43X - C53 - C83

KC 12 - KR 12 - KRB 12

- Minimum permissible length of air intake pipe is 1 meter.
- Minimum permissible length of flue gas venting pipe is 1 meter.
- Maximum permissible length of intake/flue gas venting pipes is 152 meters (combined length of air intake and flue gas venting pipe).
- For each additional 1 meter of straight pipe maximum permissible length is to be reduced by 1 meter.
- For each additional 90° elbow, maximum permissible length is to be reduced by 1 meter.
- For each additional 45° elbow, maximum permissible length is to be reduced by 0.5 metres for flue gas venting pipes and by 1.0 metre for air intake pipes.
- The roof terminal reduces maximum permissible length by 5 meters.
- The wall terminal reduces maximum permissible length by 4.5 meters.

KC 24 - KR 24 - KRB 24

- Minimum permissible length of air intake pipe is 1 meter.
- Minimum permissible length of flue gas venting pipe is 1 meter.
- Maximum permissible length of intake/flue gas venting pipes is 84 meters (combined length of air intake and flue gas venting pipe).
- For each additional 1 meter of straight pipe maximum permissible length is to be reduced by 1 meter.
- For each additional 90° elbow, maximum permissible length is to be reduced by 1 meter.
- For each additional 45° elbow, maximum permissible length is to be reduced by 0.5 meter.
- The roof terminal reduces maximum permissible length by 5.5 meters.
- The wall terminal reduces maximum permissible length by 5 meters.

KC 28 - KR 28 - KRB 28

- Minimum permissible length of air intake pipe is 1 meter.
- Minimum permissible length of flue gas venting pipe is 1 meter.
- Maximum permissible length of intake/flue gas venting pipes is 91 meters (combined length of air intake and flue gas venting pipe).
- For each additional 1 meter of straight pipe maximum permissible length is to be reduced by 1 meter.
- For each additional 90° elbow, maximum permissible length is to be reduced by 1.5 meters.
- For each additional 45° elbow, maximum permissible length is to be reduced by 1 meter.
- The roof terminal reduces maximum permissible length by 5.5 meters.
- The wall terminal reduces maximum permissible length by 5.5 meters.

KC 32 - KR 32 - KRB 32

- Minimum permissible length of air intake pipe is 1 meter.
- Minimum permissible length of flue gas venting pipe is 1 meter.
- Maximum permissible length of intake/flue gas venting pipes is 78 meters (combined length of air intake and flue gas venting pipe).
- For each additional 1 meter of straight pipe maximum permissible length is to be reduced by 1 meter.
- For each additional 90° elbow, maximum permissible length is to be reduced by 1.5 meters.
- For each additional 45° elbow, maximum permissible length is to be reduced by 1 meter.
- The roof terminal reduces maximum permissible length by 6 meters.
- The wall terminal reduces maximum permissible length by 5.5 meters.

3.6.6 Air intake and flue gas venting via 60 mm split pipes

Installation types C43 - C53 - C83

KC/KR/KRB 12 - KC/KR/KRB 24 - KC/KR/KRB 28 - KC/KR/KRB 32

- Minimum permissible length of air intake pipe is 1 meter.
- Minimum permissible length of flue gas venting pipe is 1 meter.
- Maximum permissible length of air intake/flue gas venting pipes (combined length of air intake and flue gas venting pipe) is:
 - » 24 m. for models KC/KR/KRB 12
 - » 23 m. for models KC/KR/KRB 24 and KC/KR/KRB 28
 - » 20 m. for models KC/KR/KRB 32
- For each additional 1 meter of straight pipe maximum permissible length is to be reduced by 1 meter.
- For each additional 90° elbow, maximum permissible length is to be reduced by 1 meter.
- For each additional 45° elbow, maximum permissible length is to be reduced by 0.5 meter.
- The wall terminal reduces maximum permissible length by 4 metres for KC/KR/KRB 12 models and by 4.5 metres for KC/KR/KRB 24 - KC/KR/KRB 28 - KC/KR/KRB 32 models.
- The wall terminal reduces maximum permissible length by 4.5 meters.

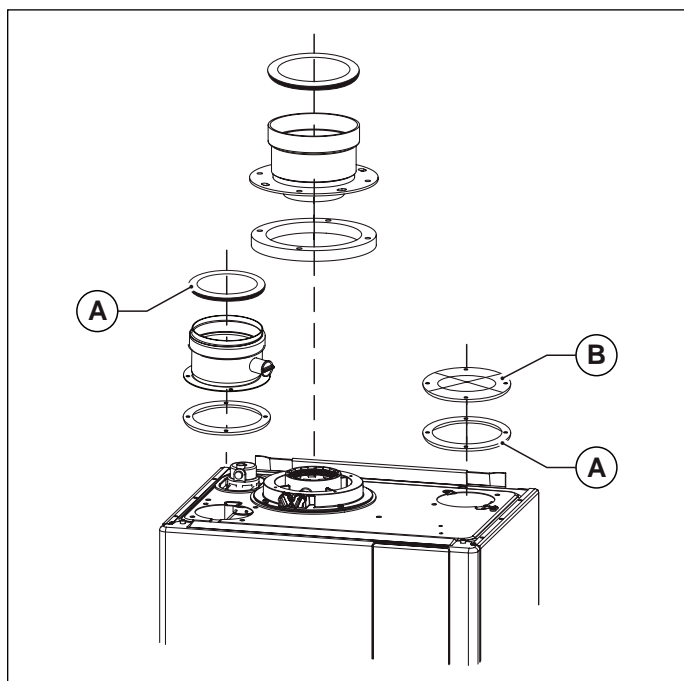

Fig. 18 Coaxial ducts C43 - C53 - C83

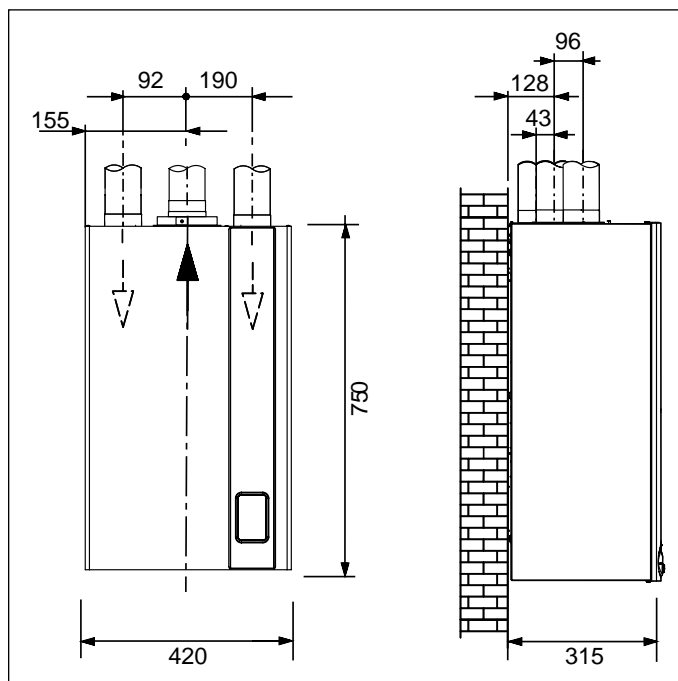









Fig. 19 Coaxial ducts C43 - C53 - C83 dimensions

- A. Gasket
- B. Blanking cap

3.7 Checking combustion efficiency

3.7.1 Flue cleaning function

- The boiler features a flue cleaning function which must be used to measure combustion efficiency during operation and to adjust the burner.
- To enable the flue cleaning function, press the  key and keep it pressed for 3 seconds.
- If the  key is released before the three seconds have elapsed, the boiler continues to operate normally.
- The  symbol steady on and the fan speed indicate that the flue cleaning function is active.
- The display shows the flow temperature and the  symbol, if burner is on. The boiler performs the ignition sequence and then operates at the burner maximum output (parameter **P4**).
- The keys active in this function are:  and **DHW +/-**.
- By pressing the **DHW +/-** keys it is possible to change the fan speed from **P5** (minimum speed) to **P4** (maximum speed). The display shows the wrench symbol (indicating that the parameter is being edited), the broom, the **H** letter (indicating Hertz), the speed set-point value in Hz, the fan current speed, and the lit flame on symbol if burner is on.
- As soon as the **DHW +/-** key is released again, the display will show fan current rpm value, flow temperature, system pressure, the lit flame on symbol, the  symbol to indicate that the flue cleaning function is active.
- The flue cleaning function lasts 15 minutes. To quit this function, press  and you will go back to the standard operating mode.

3.7.2 Measurement procedure

The boiler is equipped with a tower allowing for air intake/flue gas venting pipe connection (see Fig. 20 Plugs position and Fig. 21 Hole position).

The tower is designed with two pre-arranged openings directly accessing air and flue gas ducts (see Fig. 20 Plugs position).

Remove caps **A** and **B** from the pre-arranged openings on the tower, before starting combustion checking procedure (see Fig. 20 Plugs position).

In order to verify combustion efficiency the following measurements must be implemented:

- assess combustion air from opening **1** (see Fig. 21 Hole position).
- assess flue gas temperature and CO₂ from opening **2** (see Fig. 21 Hole position).

Allow boiler to reach working temperature before taking any measurement.

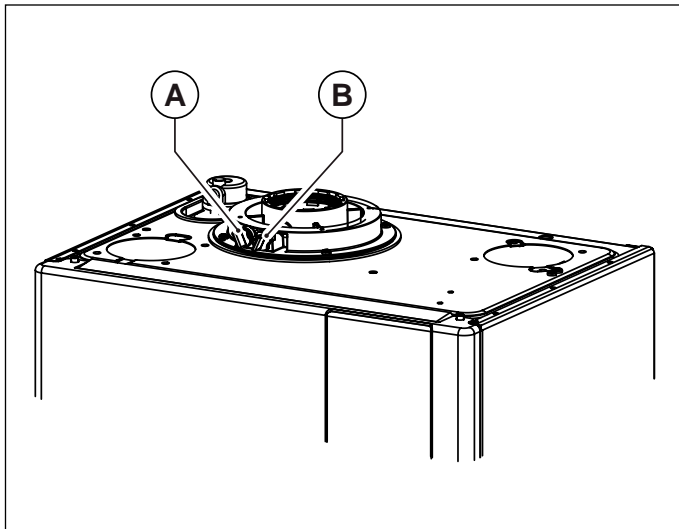

Fig. 20 Plugs position

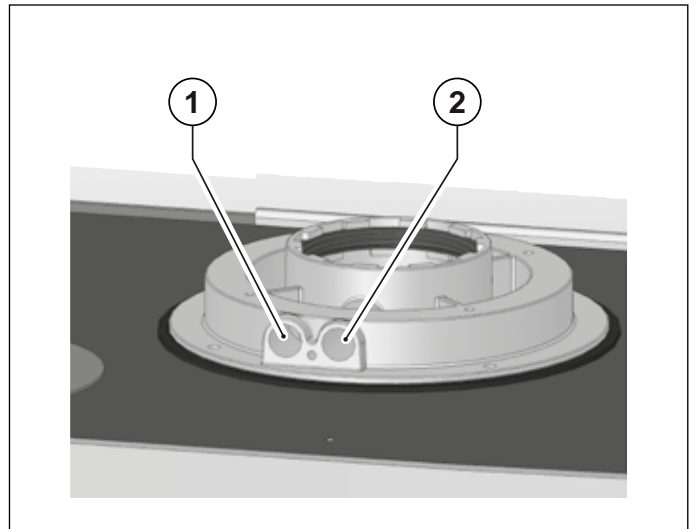

Fig. 21 Hole position

3.8 Connection to gas mains

Cross-section gas pipe size must be chosen depending on its length, layout pattern, gas flow rate.
Gas supply pipe cross-section must be equal or greater than boiler gas pipe.



DANGER

Comply with installation standards enforced in the country where the boiler is installed which are considered as fully transcribed in this booklet.

Remember that before operating an indoor gas distribution system and before connecting it to a meter, it must be checked for leaks.

If some system parts are not visible, the leak test is to be carried out before the pipes are covered.

Leak test is NOT to be carried out employing flammable gas: use air or nitrogen for this purpose.

Once gas is in the pipes, leak test by a naked flame is forbidden; use specific products available on the market.

When connecting the boiler to gas supply network, it is **COMPULSORY** to install an appropriately sized gasket (A) made from suitable material (see Fig. 22 Connection to gas mains).

The boiler gas inlet coupling is NOT suitable for hemp, teflon tape or similarly made gaskets.

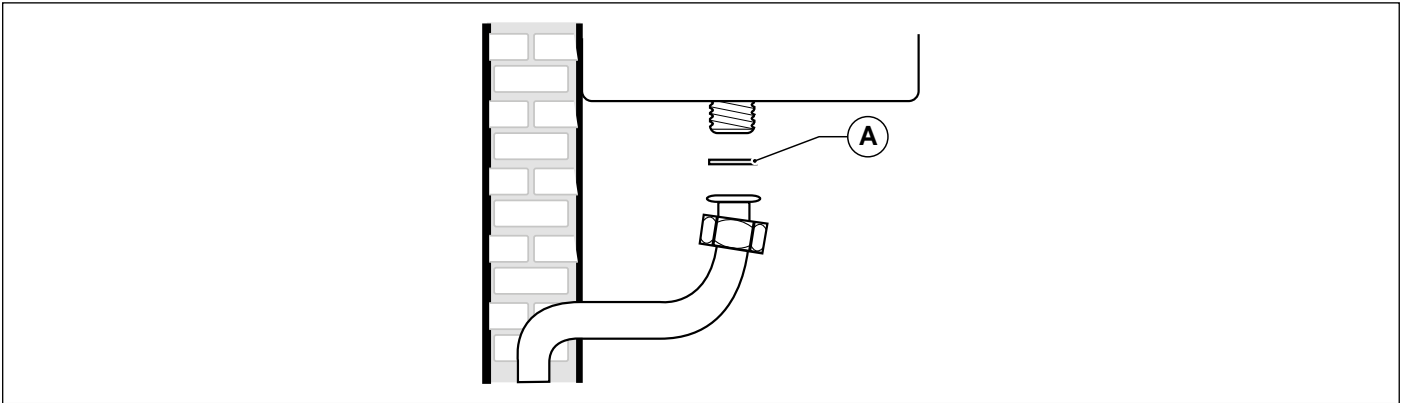

Fig. 22 Connection to gas mains

3.9 Hydraulic connections

3.9.1 Central heating

Prior to installing the boiler, the hydraulic system is to be cleaned in order to remove impurities; they could be present in system components and damage the pump and the heat exchanger.

The CH outlet and return pipes must be connected to the respective 3/4" connectors **M** and **R** on the boiler (see Fig. 9 Paper template).

When calculating the cross section of CH system pipes, bear in mind load losses induced by radiators, thermostatic valves, radiator gate valves, and the configuration of the system itself.



WARNING

It is advisable to convey the discharge flow of boiler safety valve to the sewer system. Should the above precaution not be implemented and the safety valve be activated, boiler room flooding may occur.

The manufacturer shall not be held responsible in case of damage to people, animals, or property due to failure to follow the above mentioned instructions.

3.9.2 DHW

Prior to installing the boiler, the hydraulic system is to be cleaned in order to remove impurities; they could be present in system components and damage the heat exchanger.

For KC model, cold water and domestic hot water outlet must be connected to the boiler through 1/2" **F** and **C** fittings, respectively (see Fig. 9 Paper template).

For KR model, domestic cold water outlet must be connected to the boiler through 1/2" **F** fitting (see Fig. 9 Paper template).

For KRB model, water heater return pipe and water heater flow pipe must be connected to the boiler through 1/2" **F** and **C** fittings, respectively (see Fig. 9 Paper template).

Hardness of water supplied to the boiler may increase the plate heat exchanger cleaning/replacement intervals.



WARNING

Depending on the hardness of the mains water supply, ascertain whether or not to install appropriate domestic water treatment systems using water treatment products suitable for drinking water and compliant with the regulations and standards in force in the country of installation.

Water treatment is always advisable when water supplied to the boiler is more than 20°F hard.

Water supplied by commonly marketed water softeners, due to PH level induced in water, may not be compatible with some components in the system.

3.9.3 Condensate drain

Comply with condensate drain laws and standards applicable in the country of installation, which are considered herein integrally transcribed.

Unless forbidden, the condensate produced by combustion is to be routed via the condensate drain through a discharge system connected to the domestic sewer, which due to its basicity, counteracts flue gas condensate acidity. In order to avoid domestic sewer odour to reach the premises, it is advisable to install an appropriate device between the discharge system and the domestic sewer. The condensate drain system and the domestic discharge system is to be made of an adequate, condensate-resistant material.

Condensate drain system must be connected to specific fitting (A) in the boiler (see Fig. 23 Condensate drain).

It is strictly forbidden to connect condensate drain system in trap inspection point (B).



WARNING

The manufacturer shall not be held responsible in case of damage to people, animals, or property due to failure to follow the above mentioned instructions.

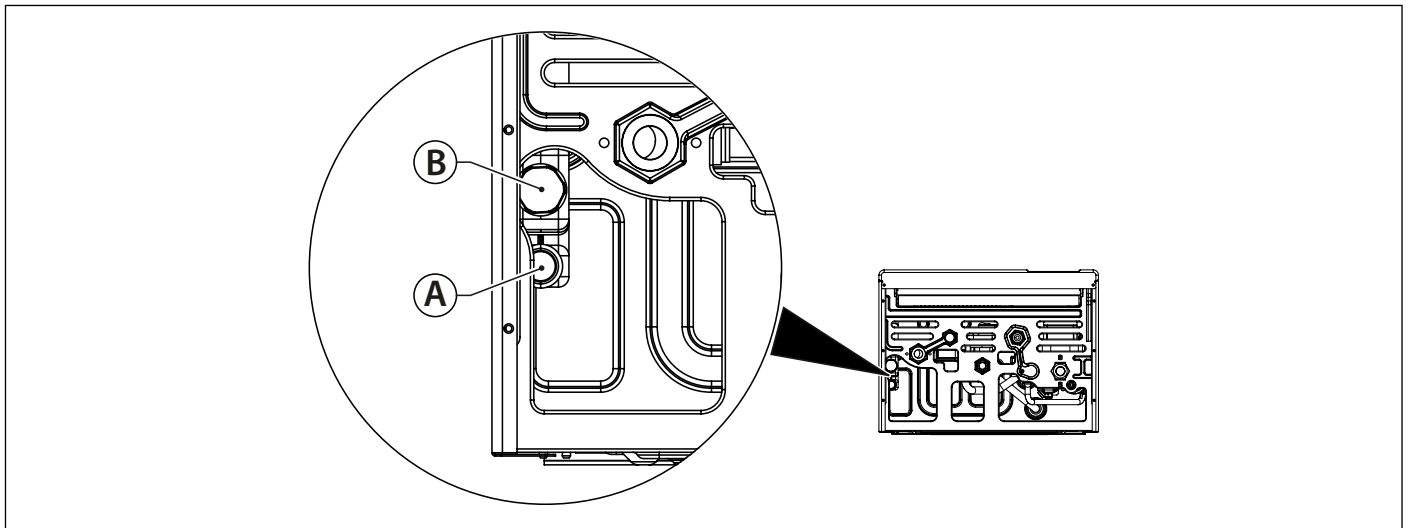

Fig. 23 Condensate drain

3.10 Connection to electrical mains

The boiler is supplied with a three-poled power cable, already connected to the electronic board and it is provided with a safety clamp. The boiler is to be connected to a 230V-50Hz electrical power supply.

When connecting it to power mains, follow correct phase / neutral polarity sequence.

Installation standards must be complied with and they are herein considered as entirely transcribed.

An easily accessible two-poled switch, with a minimum 3 mm distance between contacts, is to be installed ahead of the boiler. The switch is to allow power supply cut-off in order to safely perform maintenance and service procedures.

Power supply to the boiler must be fitted with a residual-current circuit breaker having suitable disconnection capacity. Electric power supply must be properly earthed.

The above mentioned safety measure must be verified. If in doubt, ask a qualified technician to thoroughly check the power network.



WARNING

The manufacturer cannot be held responsible for any damage caused by failure to earth the system correctly: gas, water, or CH system pipes are not suitable for grounding power networks.

3.11 Connection to ambient thermostat (optional)

The boiler is designed to be connected to an ambient thermostat (optional, not compulsory).

Ambient thermostat contacts must be properly sized in compliance with a load of 5 mA at 24 Vdc.

The ambient thermostat cables must be connected to terminals 1 and 2 of the electronic board (see par. *Wiring diagrams* on page 71) after having eliminated the jumper supplied as a standard with the boiler.

The ambient thermostat cables are not to be grouped together in the same sheath as power mains supply cables.

3.12 Installation of the (optional) external probe and sliding temperature operation

The boiler can be connected to an (optional) external temperature probe (optional, provided by the manufacturer) for sliding temperature operation.



WARNING

Only original external temperature probes supplied by the manufacturer must be used.

If non-original external temperature probes are used, correct operation of the boiler and external probe cannot be guaranteed.

The external temperature probe must be connected by means of a double insulated wire, minimum cross-section 0.35 sq.mm.

The external probe must be connected to terminals 5-6 of boiler electronic board.



WARNING

The temperature probe cables must NOT be routed together with power cables.

The temperature probe must be installed on an outside wall facing NORTH - NORTH EAST, in a position protected from weather.

Do not install near a window, ventilation openings or sources of heat.

The external temperature probe automatically modifies the CH flow temperature in relation to:

- Measured external temperature.
- Selected thermoregulation curve.
- Selected fictitious ambient temperature.

The fictitious ambient temperature is set using +/- CH buttons that, with external probe installed, no longer work to set the heating water temperature (see *Operation with external probe (optional)* on page 24).

Through boiler parameter P30 it is possible to display the value of the outside temperature detected by the external probe.

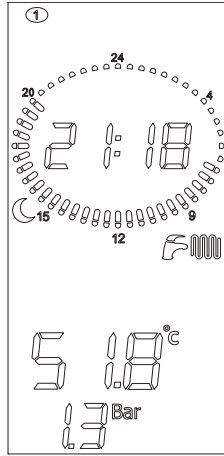

With installed external probe, press +/- CH buttons to set calculated ambient temperature. As soon as the button is released, icon  will continue flashing for approx. 3 seconds, and the calculated ambient temperature value will flash as well.

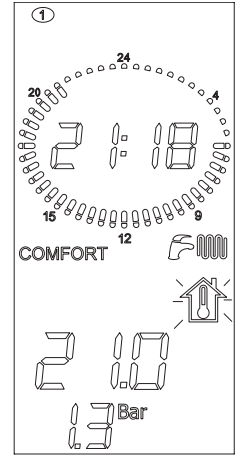

After this time, value is stored and display standard operation will be restored.

The figure shows the curves for a fictitious ambient temperature of 20°C. Parameter P10 allows selecting the curve value shown (see Fig. 24 Thermoregulation curves).

If fictitious ambient temperature value is edited on boiler display, the curves shift up or down, respectively, by the same amount.

With a fictitious ambient temperature setting of 20°C, for example, if you select the curve corresponding to parameter 1 and the outdoor temperature is -4°C, the CH flow temperature will be 50°C.

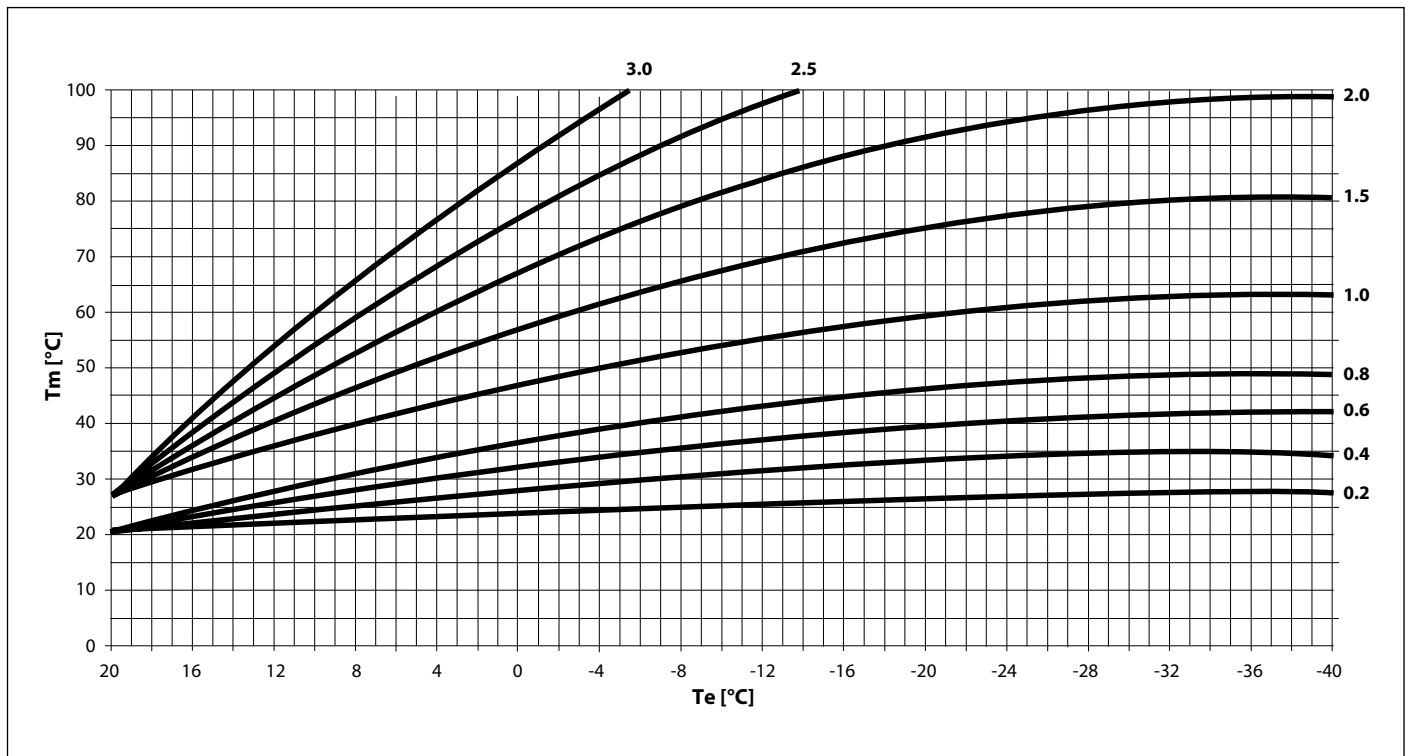

Fig. 24 Thermoregulation curves

Tm indicates flow water temperature in °C

Te indicates external temperature in °C

3.13 Room temperature installation

The boiler can be connected to sensor for room temperature measurement (supplied as standard).



WARNING

Only original ambient temperature probes supplied by the manufacturer must be used.

If non-original ambient temperature probes are used, correct operation of the boiler and ambient probe cannot be guaranteed.

The room temperature sensor must be connected by means of a double insulated wire, minimum cross-section 0.35 mm².

The ambient probe must be connected to terminals (13) and (14) of boiler electronic board.



WARNING

The ambient temperature probe cables must NOT be routed together with power cables.

The ambient probe must be installed on an indoor wall at a height of approximately 1.5 m from the floor and in a suitable location for measuring ambient temperature: do not install in recess or corners, behind doors or curtains, and install away from heat sources, direct sunlight, air draughts and water sprays.

Once ambient probe has been installed, set the following parameters (refer to *TSP parameters* on page 62):

- P17 = 1
- P57 = 1
- P61 = 3

The ambient probe automatically modifies the CH flow temperature in relation to:

- Measured ambient temperature.
- Selected ambient temperature.

Through boiler parameter **P49** it is possible to display the value of the ambient temperature detected by the probe SA1.

3.14 Selecting the operating range in heating mode

Heating water temperature adjustment range depends on the selected operating range.:

- **standard range:** from 20°C to 78°C (pressing **CH +/-**);
- **reduced range:** from 20°C to 45°C (pressing **CH +/-**).

The standard range is active with curves **P10** ≥ 1, while the reduced range is active with curves **P10** < 1.

The two ranges can also be selected even with the external probe disconnected.

The waiting time between one boiler ignition and the following one, used to prevent boiler frequent turning on and off is 4 minutes for both ranges, and can be edited with the parameter **P11**.

If system water temperature decreases below a certain value, the waiting time is reset and the boiler re-ignited, as shown in the following table:

Selected range	Re-ignition temperature
Standard range	< 30°C (P27)
Reduced range	< 20°C

Tab. 15 Boiler re-ignition temperature

Operation range selection is to be implemented by a qualified installer or a Service Centre.

3.15 Installation and operation with Open Therm Remote Control (optional)



WARNING

Only use original Remote Control Units supplied by the manufacturer.

The correct operation of the Remote Control itself and of the boiler is not guaranteed if non original Remote Control units not supplied by the manufacturer are used.

The boiler may be connected to an Open Therm Remote Control (non-compulsory optional accessory supplied by manufacturer).

The Remote Control must only be installed by qualified personnel.

To install the Remote Control, refer to the instructions provided with the Remote Control itself.

The Remote Control must be installed on an indoor wall at a height of approximately 1.5 m from the floor and in a suitable location for measuring ambient temperature: do not install in recess or corners, behind doors or curtains, and install away from heat sources, direct sunlight, air draughts and water sprays.

The Remote Control cables must be connected to terminals 3 and 4 of the electronic board (see par. *Wiring diagrams* on page 71).

The Remote Control connector is protected against inverted polarity, and the connections may be inverted.



WARNING

Do not connect the remote control to mains electrical power 230 V ~ 50 Hz.

The remote control wiring must not be grouped together in the same sheath as the power cables: if the cables are sheathed together, electrical interference from the power cables may compromise the functions of the Remote Control.

For complete instructions on how to program the Remote Control, refer to the instruction manual included in the Remote Control kit.

Board and Remote Control communicate in each operating mode: OFF, SUMMER, WINTER, CH ONLY.

Boiler display layout corresponds to the setting made from the Remote Control, as for the operating mode.

The remote control may be used to view and set a number of special parameters denominated **TSP** parameters and reserved solely for qualified technicians.



Setting the **TSP0** parameter sets the default data table and reloads all original data, cancelling any modifications previously made to individual parameters.

If a single parameter is found to be incorrect, the value given in the default value table is restored.

If the user attempts to set a value not within the permissible range for the parameter, the new value is rejected and the existing value is maintained.

3.16 TSP parameters

The boiler operation is controlled by several parameters.

To change the parameters, press  and  at the same time for 3 seconds. Scroll through the parameters by pressing +/- CH buttons.

Set onto the required one and press .

The  symbol turns on to indicate that you can edit the parameter value.

The parameter value can be changed with the +/- HEATING buttons.

To confirm modification press .

To quit the parameter editing mode press .



WARNING

**Parameters must be changed by qualified personnel, only.
Editing these parameters may affect boiler correct operation.**

Parameter	Settable values	Default values	Notes
P0 - TSP0 Boiler power selection	0 ÷ 7	According to the model	0 = 12 kW Natural gas; 1 = 24 kW Natural gas 2 = 28 kW Natural gas; 3 = 24 kW Propane 4 = 28 kW Propane; 5 = 12 kW Propane 6 = 32 kW Natural gas; 7 = 32 kW Propane
P3 - TSP3 Boiler type selection	1 ÷ 3	According to the model	1 = combined instantaneous 2 = heating only 3 = with water heater
P4 - TSP4 Fan speed at burner maximum output	TSP5 ÷ 250 Hz	According to the model	12 kW natural gas = 182; 12 kW propane = 177 24 kW Natural gas = 197; 24 kW Propane = 192 28 kW natural gas = 205; 28 kW propane = 200 32 kW natural gas = 208; 32 kW propane = 206
P5 - TSP5 Fan speed at burner minimum output	25 - 120 Hz	According to the model	12 kW natural gas = 37; 12 kW propane = 38 24 kW = 40 28 kW = 39 32 kW = 43
P6 - TSP6 Fan speed at ignition power	25 - 160 Hz	According to the model	12 kW = 68; 24 kW = 58 28 kW = 60; 32 kW = 76
P7 - TSP7 Fan speed at heating maximum output	10 ÷ 100%	According to the model	12 kW natural gas = 76; 12 kW propane = 74 24 kW = 88 28 kW natural gas = 89; 28 kW propane = 88 32 kW natural gas = 89; 32 kW propane = 88
P8 - TSP8 Negative ramp start minimum speed	P5 ÷ P6	According to the model	12 kW = 56; 24 kW = 56 28 kW = 60; 32 kW = 60
P9 - TSP9 Negative ramp time	0 ÷ 30 (1 = 10 sec.)	According to the model	12 kW = 18; 24 kW = 18 28 kW = 25; 32 kW = 18
P10 - TSP10 Heating output curves	0 ÷ 3	1,5	-
P11 - TSP11 Heating thermostat timing	0 ÷ 10 min.	4	-
P12 - TSP12 CH power rising ramp timer	0 ÷ 10 min.	1	-
P13 - TSP13 Timer for CH post-circulation, freeze protection and flue cleaning function, configurable	30 ÷ 180 sec.	30	-

Tab. 16 List of parameters - I

Parameter	Settable values	Default values	Notes
P14 - TSP14 Setting of "solar" DHW thermostats	0 ÷ 1	1	0 = normal; 1 = solar
P15 - TSP15 Water hammer protection delay, configurable	0 ÷ 3 sec.	0	-
P16 - TSP16 Ambient thermostat reading delay / OT	0 ÷ 199 sec.	0	-
P17 - TSP17 Multifunction relay setting	0 ÷ 3	0	0 = shut-down and fault 1 = remote relay/TA1 2 = solar relay 3 = TA2 request
From P18 to P26 see "Solar parameters (with P17=2 or with supplementary board)"			
P27 - TSP27 Heating timer reset temperature	20 ÷ 78 °C	P10 < 1 (low temp.) = 20 °C; P10 > 1 (high temp.) = 40 °C	
P29 - TSP29 Setting of default parameters (except P0, P1, P2, P17)	0 ÷ 1	0	-
From P30 to P50 see "Display only"			
P51 SA1 ambient probe triggering differential OFF	0.0 ÷ 1.0 °C	0.0 °C	only with connected ambient probe
P52 SA1 ambient probe triggering differential ON	-1.0 ÷ -0.1 °C	-0.5 °C	only with connected ambient probe
P53 Ambient probe SA1 correction range	-5.0 ÷ 5.0 °C	0.0 °C	only with connected ambient probe
P54 SA2 ambient probe triggering differential OFF	0.0 ÷ 1.0 °C	0.0 °C	only with connected ambient probe
P55 SA2 ambient probe triggering differential ON	-1.0 ÷ -0.1 °C	-0.5 °C	only with connected ambient probe
P56 Ambient probe SA2 correction range	-5.0 ÷ 5.0 °C	0.0 °C	only with connected ambient probe
P57 Type of modulation with connected ambient probes (only if P61 is between 03 and 07)	0 ÷ 4	4	0 = on/off 1 = ambient probe modulation 2 = external probe modulation 3 = ambient probe and external probe modulation 4 = no ambient probe connected
P58 Ambient probe weight during modulation	0 ÷ 20 °C	8 °C	used for thermoregulation with P57=3

Tab. 17 List of parameters - II

Parameter	Settable values	Default values	Notes
P59 Type of temperature visualization on display	0 ÷ 7	0	0 = flow temp. 1 = SA1 probe temp. 2 = SA2 probe temp. 3 = external temp. 4 = water heater temp. 5 = solar collector temp. 6 = solar valve temp.
P60 Number of additional boards connected	0 ÷ 4	0	Maximum 4 boards (3 zone + 1 solar)
P61 Remote Control - room thermostats association	00 ÷ 07	00	00 = remote zone 2 / TA2 zone 1 01 = TA1 zone 2 / TA2 zone 1 02 = TA2 zone 2 / remote zone 1 03 = SA1 zone 1 / TA2 zone 2 04 = SA1 zone 1 / SA2 zone 2 05 = remote zone 1 / SA2 zone 2 06 = zone 1 not managed / SA2 zone 2 07 = TA1 zone 1 / SA2 zone 2
P62 Selection of zone 2 curve	0 ÷ 3	0,6	only with zone board connected
P63 Zone 2 set-point (fictitious temp.)	15 ÷ 35 °C	20 °C	only with zone board connected
P66 Selection of zone 3 curve	0 ÷ 3	0,6	only with two zone boards connected
P67 Zone 3 set-point (fictitious temp.)	15 ÷ 35 °C	20 °C	only with two zone boards connected
P70 Selection of zone 4 curve	0 ÷ 3	0,6	only with three zone boards connected
P71 Zone 4 set-point (fictitious temp.)	15 ÷ 35 °C	20 °C	only with three zone boards connected
P74 Low temperature zone mixer valve opening time	0 ÷ 300 sec.	140 sec.	only with zone boards connected
P75 Rise in nominal boiler temperature with zone board	0 ÷ 35 °C	5 °C	only with zone boards connected
P76 Thermal discharge enabling with solar board	0 ÷ 1	0	0 = disabled; 1 = enabled
P78 Interface back-lighting switching on	0 ÷ 2	0	0 = standard 1 = LCD always on 2 = LCD and keys always ON
From P80 to P92 see "System check"			
P93 DHW 3-star rating, with connected Remote Control	0 ÷ 1	0	0 = OFF; 1 = ON
P94 Automatic filling procedure activation	0 ÷ 1	1	0 = disabled; 1 = enabled

Tab. 18 List of parameters - III

Parameter	Settable values	Default values	Notes
P18 - TSP18 Solar plant type choice	0 ÷ 1	0	0 = solar valve 1 = solar pump
P19 - TSP19 Water heater set-point setting	10 ÷ 90 °C	60 °C	only with P18 = 1
P20 - TSP20 ΔT ON (diff. for solar pump switch-on)	1 ÷ 30 °C	6 °C	
P21 - TSP21 ΔT OFF (diff. for solar pump shut-down)	1 ÷ 30 °C	3 °C	
P22 - TSP22 Maximum collector temperature	80 ÷ 140 °C	120 °C	
P23 - TSP23 Minimum collector temperature	0 ÷ 95 °C	25 °C	
P24 - TSP24 Solar collector freeze protection	0 ÷ 1	0	0 = freeze protection inactive 1 = freeze-protection active (only with P18 = 1)
P25 - TSP25 Solar load forcing	0 ÷ 1	0	0 = automatic operation 1 = always active
P26 - TSP26 Enabling of water heater cooling	0 ÷ 1	0	0 = disabled 1 = enabled (with P18 = 1 only)

Tab. 19 Solar parameter (with P17=2 or with supplementary board)

Parameter	Settable values	Default values	Notes
P80 Multifunction relay forcing	0 ÷ 1	0	0 = standard function 1 = relay energised
P81 Zone 2 pump relay forcing	0 ÷ 1	0	0 = standard function 1 = relay energised
P82 Zone 2 mixing valve forcing	0 ÷ 2	0	0 = standard function 1 = force opening 2 = force closing
P84 Zone 3 pump relay forcing	0 ÷ 1	0	0 = standard function 1 = relay energised
P85 Zone 3 mixing valve forcing	0 ÷ 2	0	0 = standard function 1 = force opening 2 = force closing
P87 Zone 4 pump relay forcing	0 ÷ 1	0	0 = standard function 1 = relay energised
P88 Zone 4 mixing valve forcing	0 ÷ 2	0	0 = standard function 1 = force opening 2 = force closing
P91 Solar PCB forcing	0 ÷ 1	0	0 = standard function 1 = relay energised
P92 Solar PCB valve relay forcing	0 ÷ 2	0	0 = standard function 1 = force opening 2 = force closing

Tab. 20 System check

Parameter	Settable values	Default values	Notes
P30 External temperature	-	-	only with external probe connected
P31 Flow temperature	-	-	-
P32 Nominal calculated flow temperature	-	-	only with external probe connected
P33 Set point of zone 2 flow temperature	-	-	only with at least one zone board connected
P34 Current zone 2 flow temperature	-	-	only with at least one zone board connected
P36 Set point of zone 3 flow temperature	-	-	only with two zone boards connected
P37 Current zone 3 flow temperature	-	-	only with two zone boards connected
P39 Set point of zone 4 flow temperature	-	-	only with three zone boards connected (optional)
P40 Current zone 4 flow temperature	-	-	only with three zone boards connected (optional)
P42 DHW plate exchanger temperature	-	-	only for KC models
P43 Boiler return temperature	-	-	-
P44 Water heater temperature (KR/KRB models) Cold domestic water temperature (model KC)	-	-	For KR/KRB models with connected water heater probe only
P44 Water heater temperature	-	-	only with water heater probe connected
P45 Flue gas temperature	-	-	-
P46 Solar collector temperature	-	-	only with solar collector probe connected
P47 Water heater or solar valve	-	-	only with water heater probe or solar valve connected
P48 Water heater or solar PCB valve temperature	-	-	with water heater probe or solar valve connected only, but in both cases with solar board connected
P49 Ambient probe SA1 temperature	-	-	only with connected ambient probe
P50 Ambient probe SA2 temperature	-	-	only with connected ambient probe

Tab. 21 Display only

3.17 Filling the system

Once all boiler connections have been completed, CH system can be filled.

The procedure is to be cautiously carried out, following each step:

- Open the bleeding valves on all radiators and verify the boiler automatic valve operation.
- Gradually open specific filling cock (see Fig. 2 Filler cocks) or the cock on the cold water supply pipe for KR/KRB model), checking any automatic bleeding valves installed in the system work properly.
- Close all radiator bleeding valves as soon as water starts coming out.
- Check on pressure gauge that water pressure reaches the 1÷1.3 bar reading.
- Check on boiler display that water pressure reaches the 1÷1.3 bar reading.
- Shut the filler cock and bleed any air out again, by opening the air bleeding valves on radiators.
- Start the boiler and bring the system to working temperature, stop the pump, and repeat air bleeding procedure.
- Allow the system to cool and restore water pressure to 1÷1.3 bars.



WARNING

Pressure sensor will not electrically enable the burner ignition when water pressure is below 0.4 bar (this parameter can be edited by qualified professional staff).

Water pressure in the CH system must not be lower than 1 bar. In case it is not so, fill the system with water (see *Shut-down due to low water pressure* on page 25).

The procedure is to be followed while the system is cold.

Digital pressure gauge is used to read pressure inside the heating circuit.



WARNING

As for water treating in the domestic heating systems in order to optimise efficiency and safety, ensure a long life, trouble-free operation of auxiliary equipment, minimise power consumption, thereby integrating the standards and rules in force in the country of installation, it is recommended to use specific products suitable for multi-metal heating systems.

3.18 Starting up the boiler

3.18.1 Preliminary checks

Before starting the boiler, check that:

- The flue gas venting duct and the relevant terminal are installed in conformity with the instructions: with the boiler operating, there must be no leakage of combustion by-products from any of the gaskets.
- The supply power to the boiler must be 230 V ~ 50 Hz.
- The heating system is correctly filled with water (pressure gauge reading 1÷1.3 bar).
- Any shut-off cocks in the system pipes are open.
- The mains gas type is correct for the boiler calibration: convert the boiler to the available gas if necessary (see *Adaptation to other gas types and burner adjustment* on page 83). This operation is to be exclusively carried out by qualified personnel.
- The gas supply cock is open.
- There are no fuel gas leaks.
- The main switch installed adjacent to the boiler is turned on.
- The safety valve is not blocked.
- There are no water leaks.
- The condensate trap installed on the boiler is discharging condensate correctly and is not stuck.

3.18.2 Switching on and switching off

To switch the boiler on and off, refer to the “**Instructions for the User**” (see *Instructions for the user* on page 11).

3.19 Available head

The boiler is equipped with a high-efficiency circulation pump with variable speed.

Circulation pump speed is automatically managed by the electronics, according to the settings of boiler parameters.

It is possible to choose between two pump working modes:

1 "Constant ΔT " operation

In the constant ΔT operating mode, circulation pump speed changes automatically to keep system delivery and return ΔT fixed at a value set in the boiler "super technical" parameters.

2 "Fixed speed" operation

In the fixed speed operating mode, circulation pump speed remains constant at the value set in the boiler "super technical" parameters.

During DHW phase, circulation pump works at a fixed speed set in the boiler parameters.



WARNING

Circulation pump is set to constant ΔT operating mode during production.

For a correct operation of the boiler, it is recommended not to change factory setting.

Should it be necessary to change circulation pump settings, contact a Service Centre.

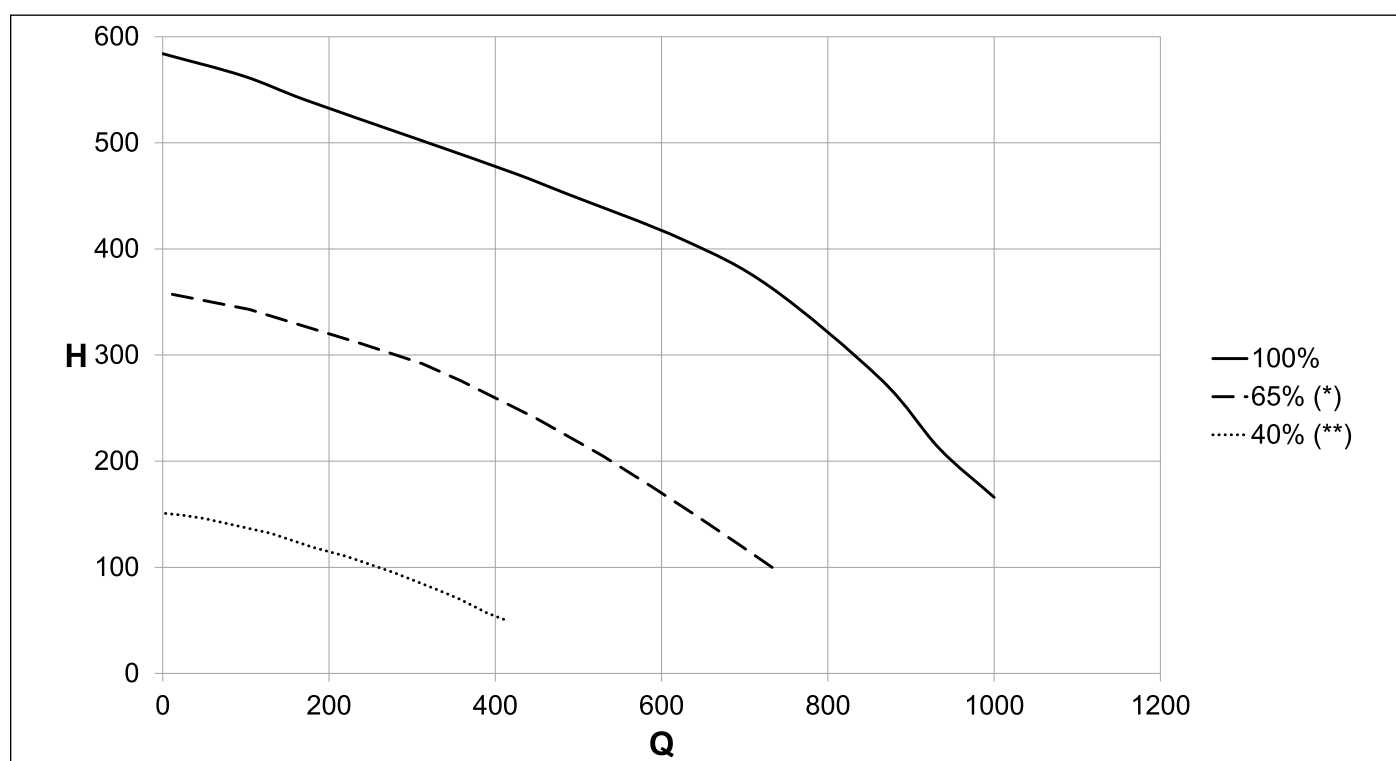

Fig. 25 Available head KC-KR-KRB 12

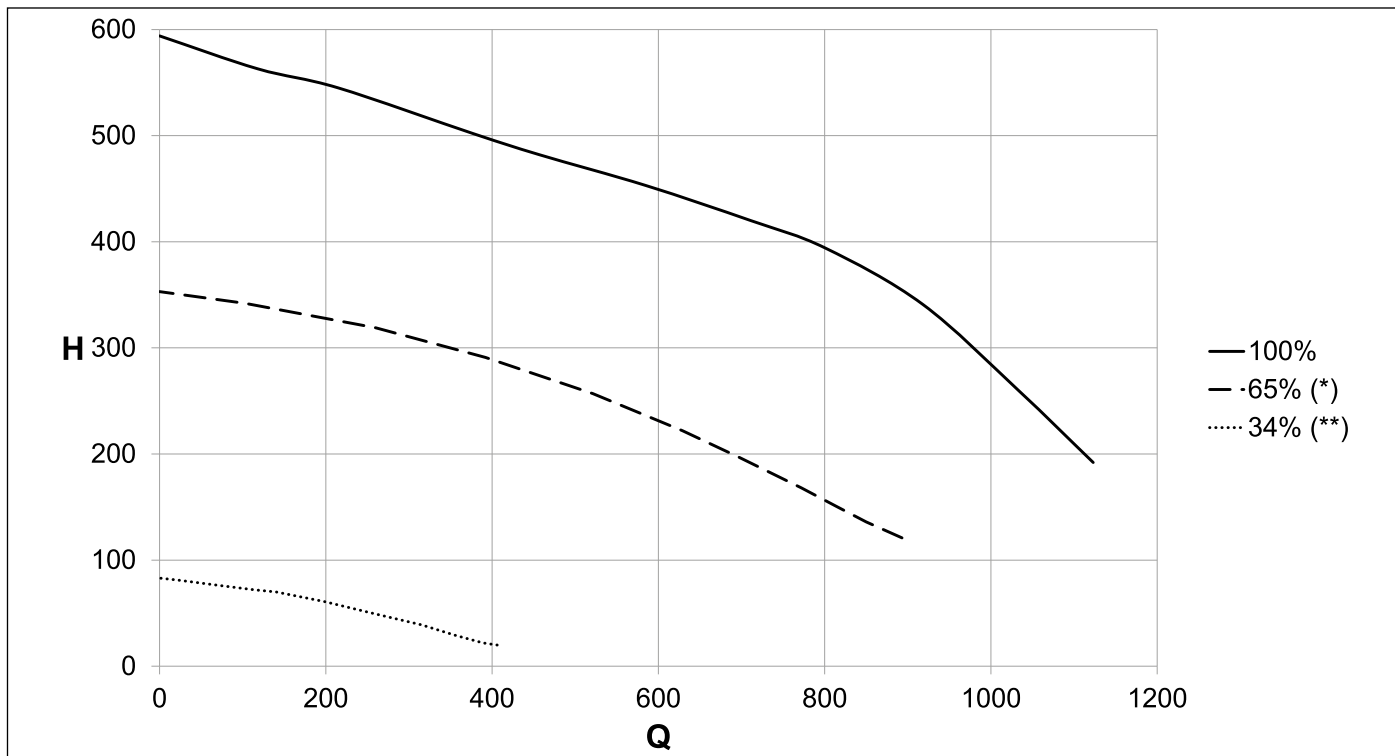

Fig. 26 Available head KC-KR-KRB 24

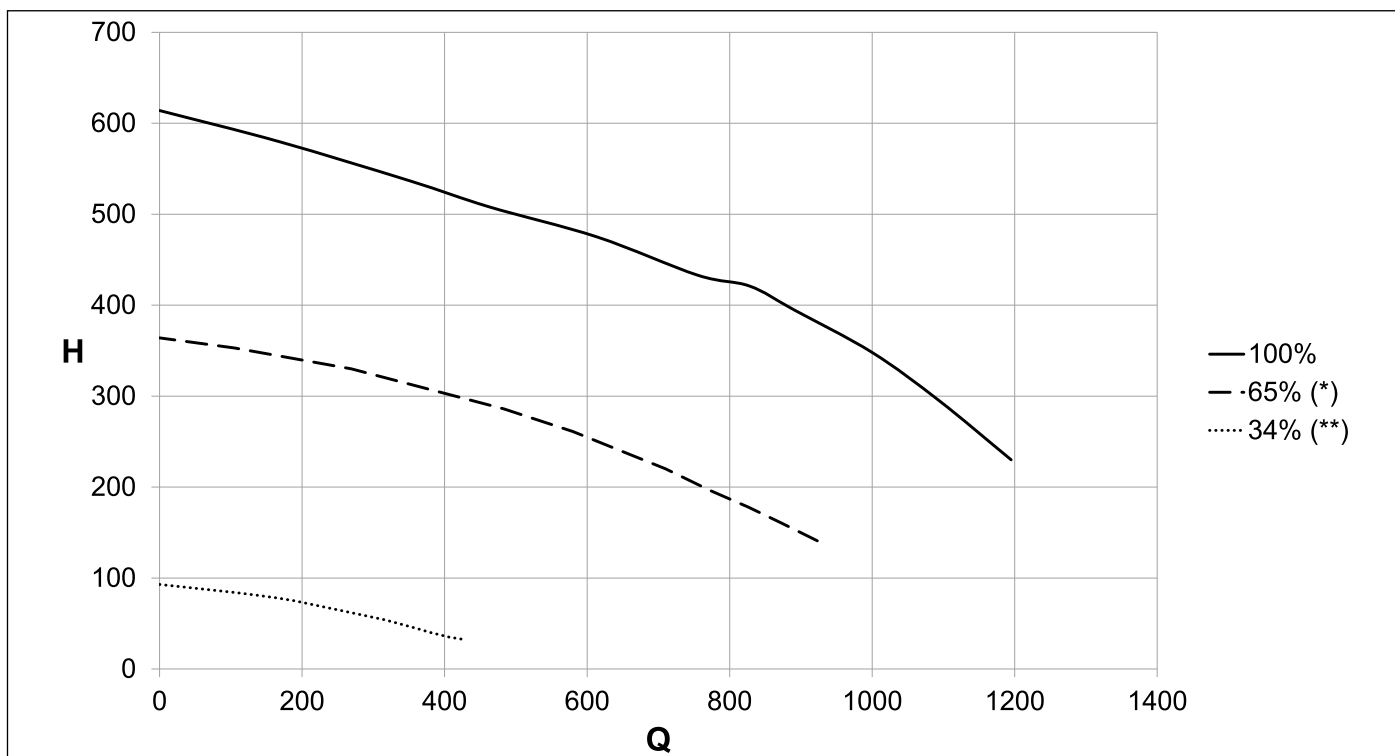

Fig. 27 Available head KC-KR-KRB 28

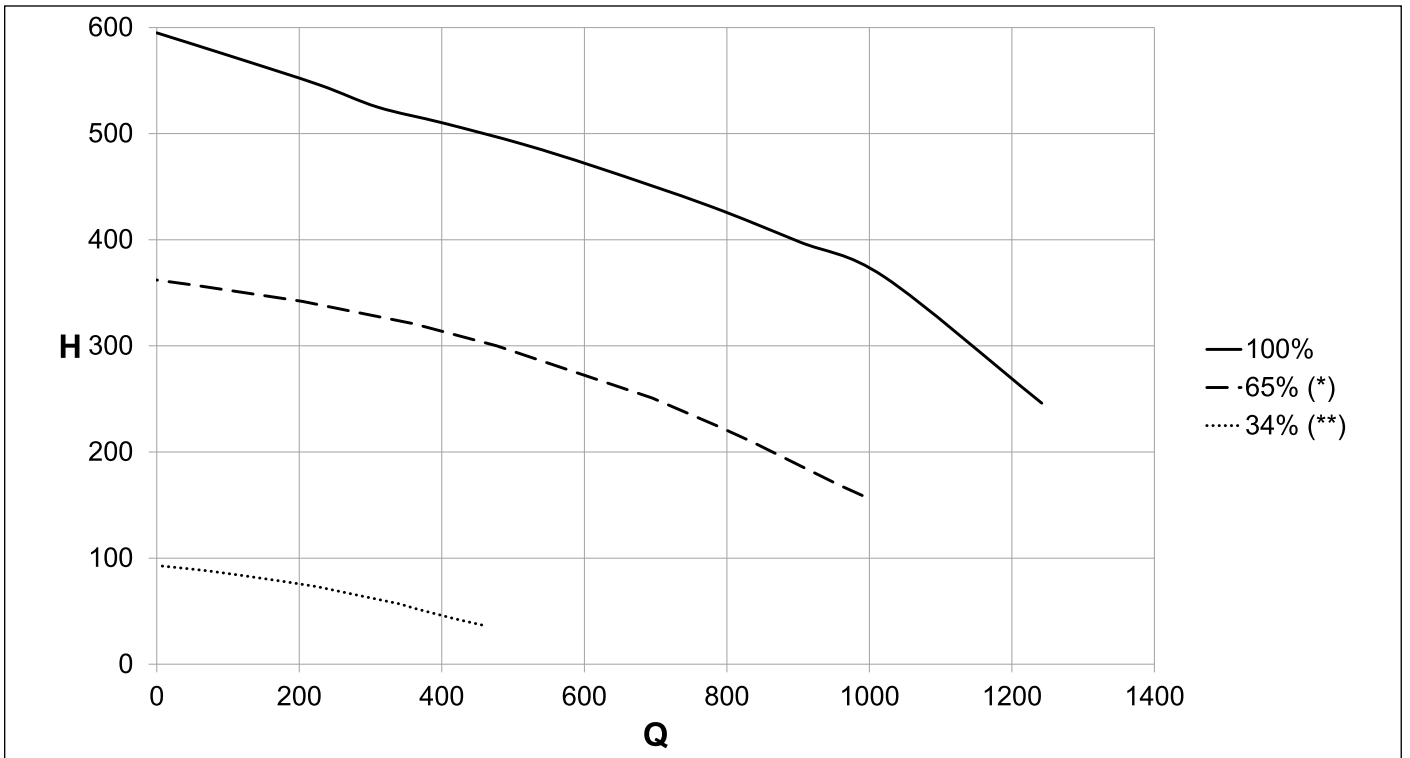

Fig. 28 Available head KC-KR-KRB 32

Q Flow rate (l/h)

H Available head (mbar)

(*) Minimum curve that can be used in systems without hydraulic separator

(**) Minimum curve that can be used in systems with hydraulic separator

3.20 Wiring diagrams

3.20.1 Wiring diagram KC

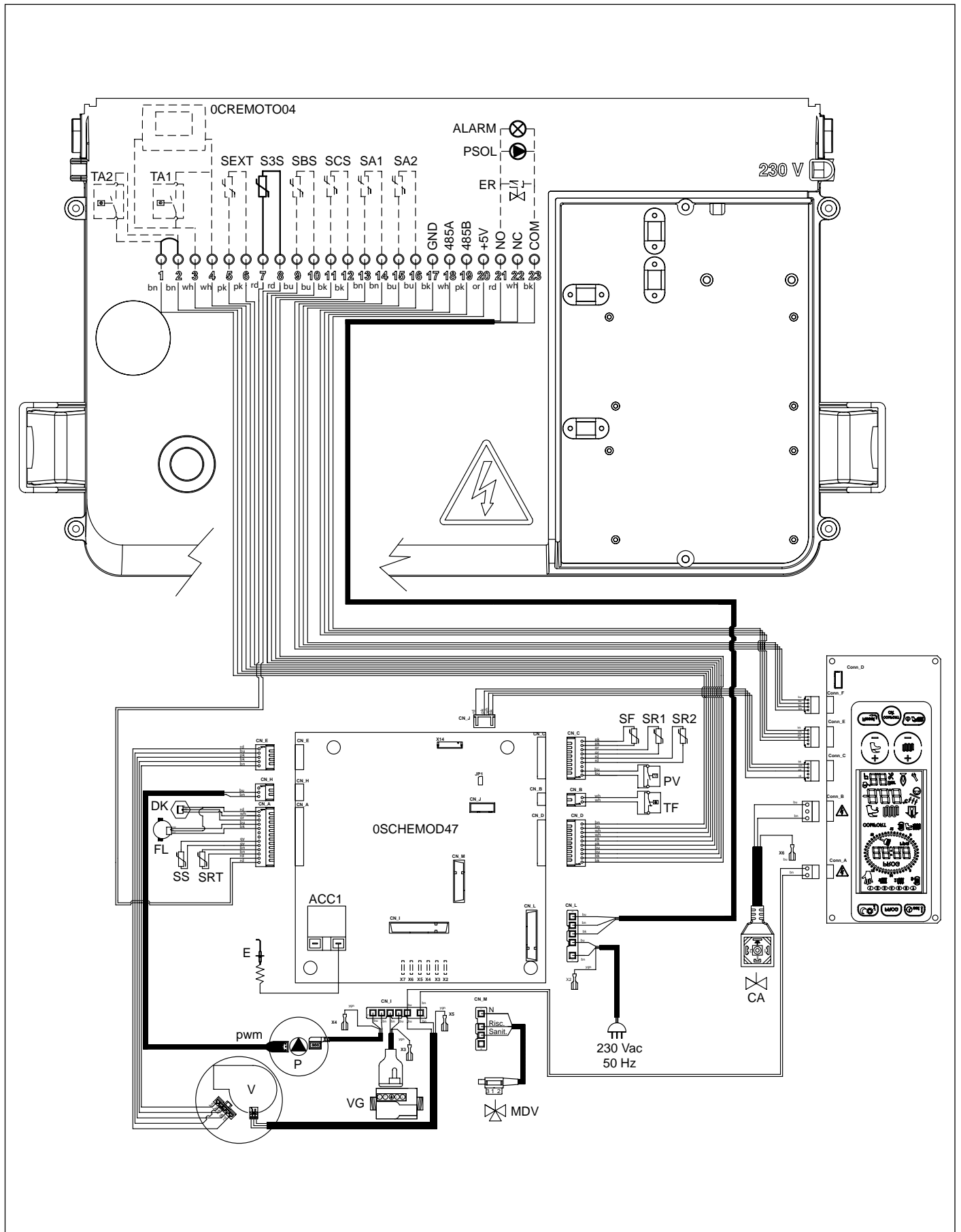

Fig. 29 Wiring diagram KC

Internal connections

- DK: pressure transducer
- FL: Flow meter
- SS: DHW NTC 'OUT' probe 10k Ohm a 25°C B=3435
- S3S: DHW NTC 'IN' probe 10k Ohm a 25°C B=3435
- SRT: return NTC temperature probe 10k Ohm a 25°C B=3435
- SR1-SR2: CH NTC temperature probe 10k Ohm a 25°C B=3435
- SF: flue gas NTC probe 10k Ohm a 25°C B=3435
- TF: flue gas thermostat
- PV: air pressure switch
- VG: gas valve
- P: boiler pump
- PWM: PWM signal cable for circulation pump
- MDV: electric deviating valve
- E: ignition/flame detection electrode
- V: brushless fan
- ACC1: ignition transformer
- CN_A-CN_M: .. Load/signal connectors
- X2-X7: ground connectors

Connections performed by the installer

- 1-2: TA2 - ambient thermostat 2
- 3-4: OT or TA1 - Remote Control or ambient thermostat
- 5-6: SEXT - external probe (10K Ohm B=3977 at 25° C)
- 7-8: S3S - DHW inlet probe (10K Ohm B=3435)
- 9-10: SBS - Solar water heater probe (PT1000)
- 11-12: SCS - Solar collector probe (PT1000)
- 13-14: SA1 - ambient probe 1
- 15-16: SA2 - ambient probe 2
- 17-18-19-20: ... 485 port for connection of additional boards
 - 17: GND
 - 18: A
 - 19: B
 - 20: +5V
- 21-22-23: Programmable relay
 - 21: line (NO normaly open)
 - 22: line (NC normaly close)
 - 23: neutral (COMMON)

3.20.2 Wiring diagram for forced circulation solar system with combi boiler

Parameter setting

P03 : 1

P17 : 2

P18 : 1

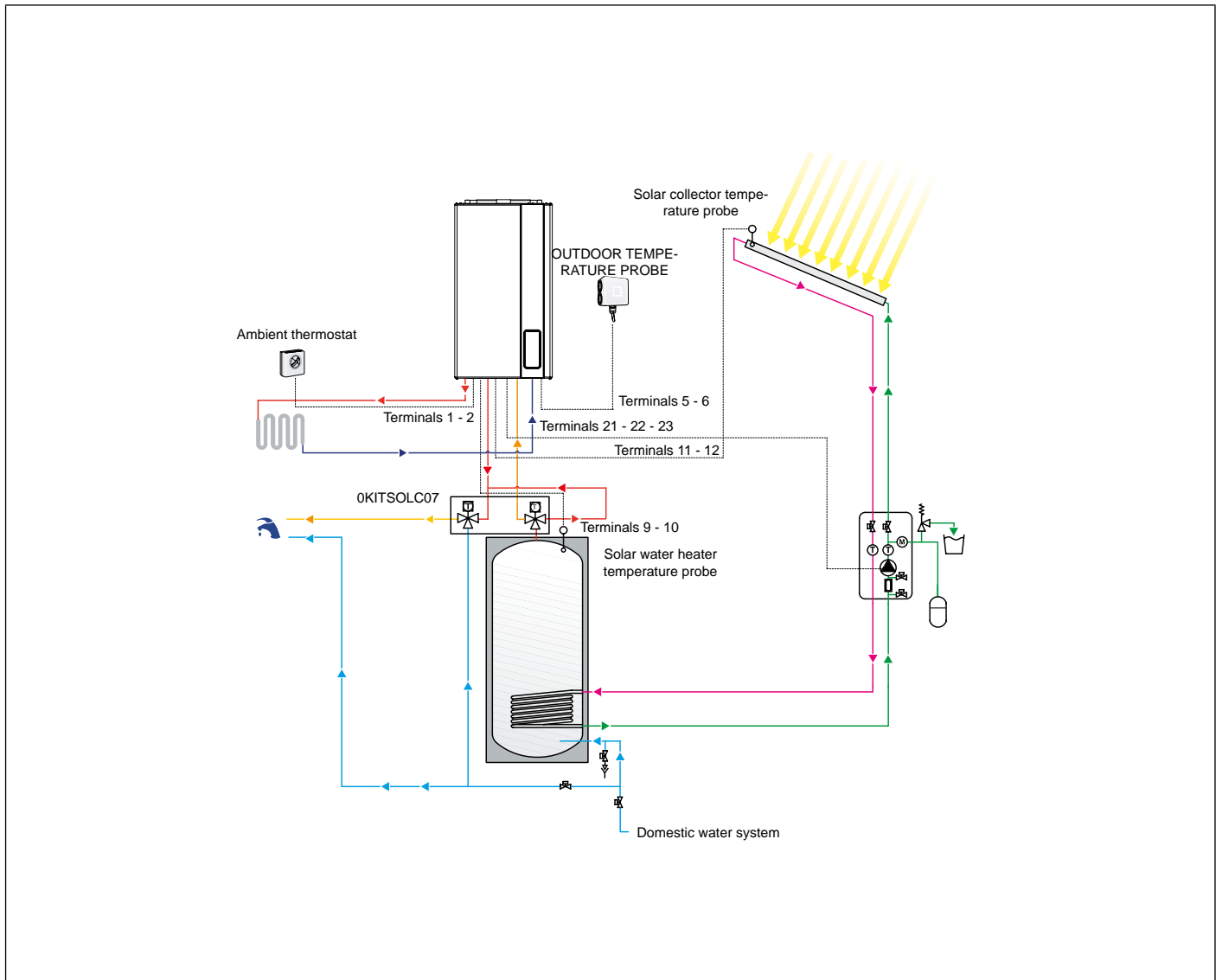

Fig. 30 Wiring diagram for forced circulation solar system with combi boiler

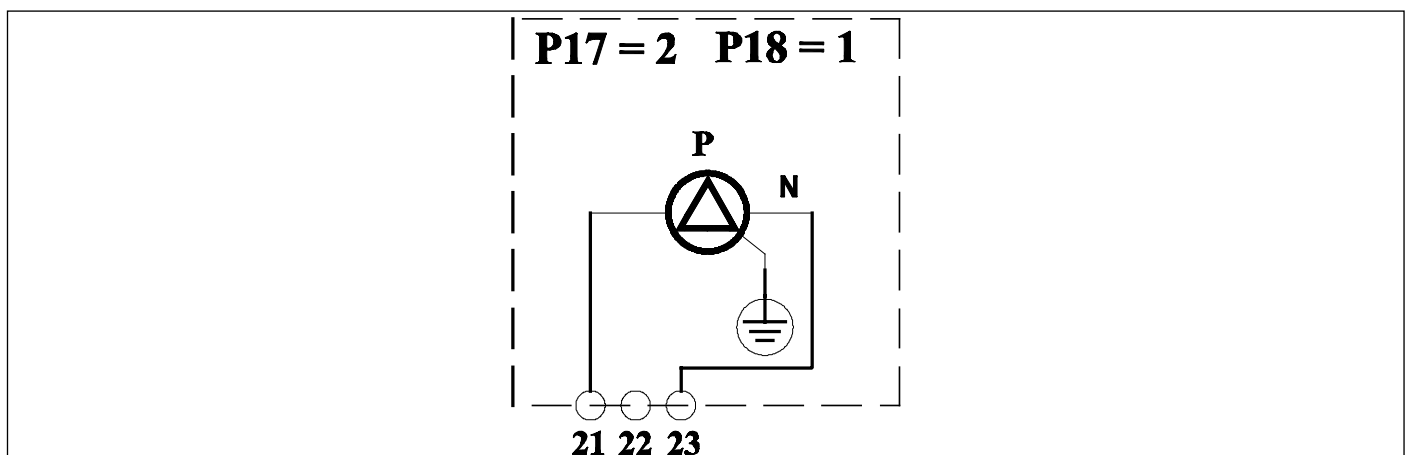

Fig. 31 Multifunction relay connection diagram

3.20.3 Wiring diagram for natural circulation solar system with combi boiler

Parameter setting

P03 : 1

P17 : 2

P18 : 0

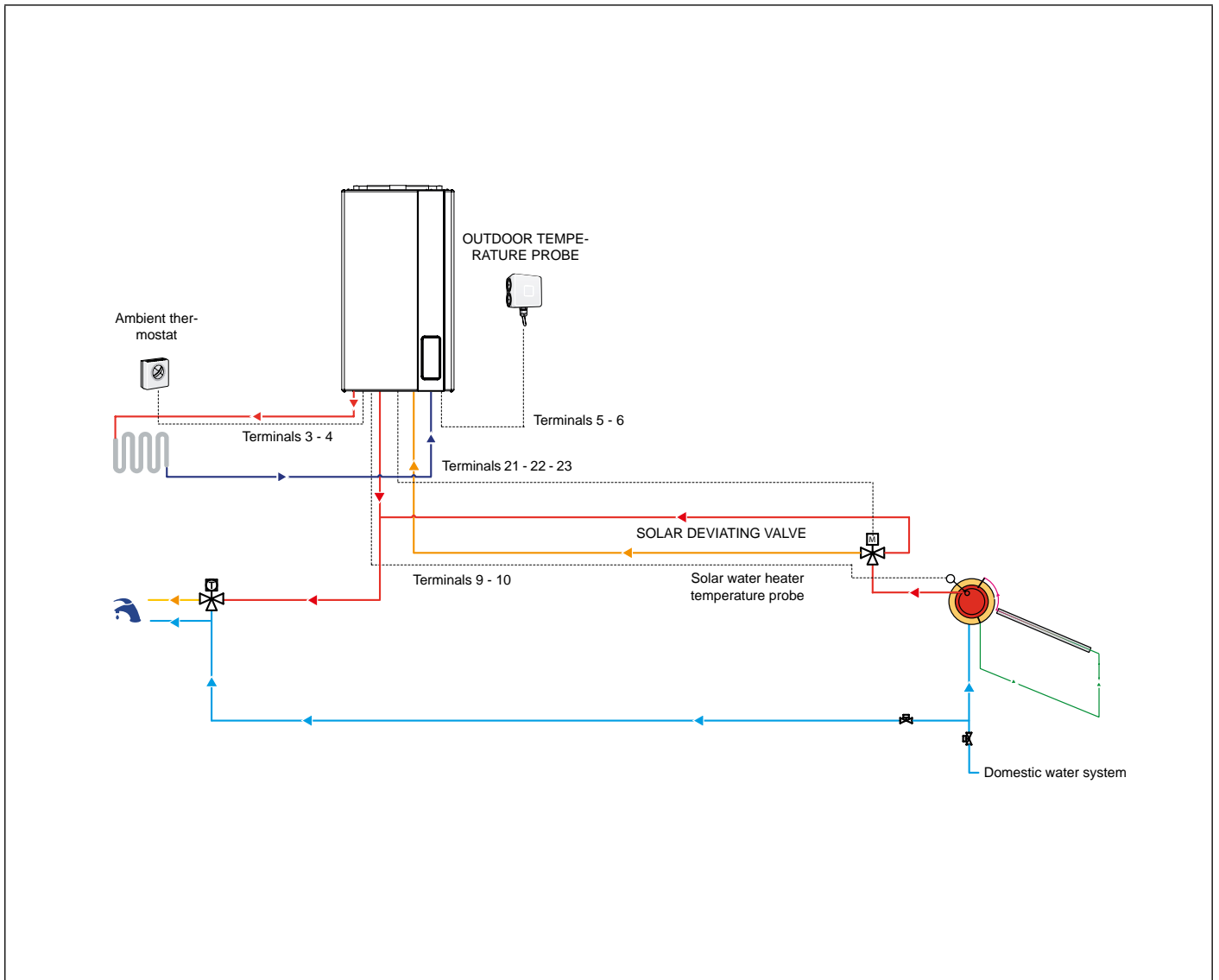

Fig. 32 Wiring diagram for natural circulation solar system with combi boiler

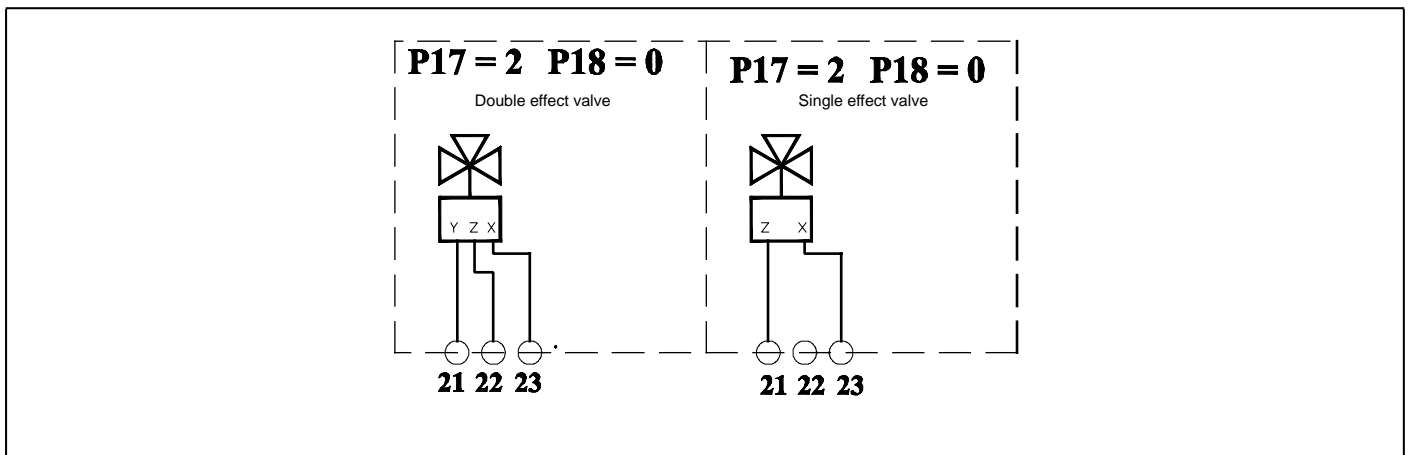

Fig. 33 Multifunction relay connecting diagram (X = neutral; Y = to boiler; Z = to collector)

3.20.4 Wiring diagram KR

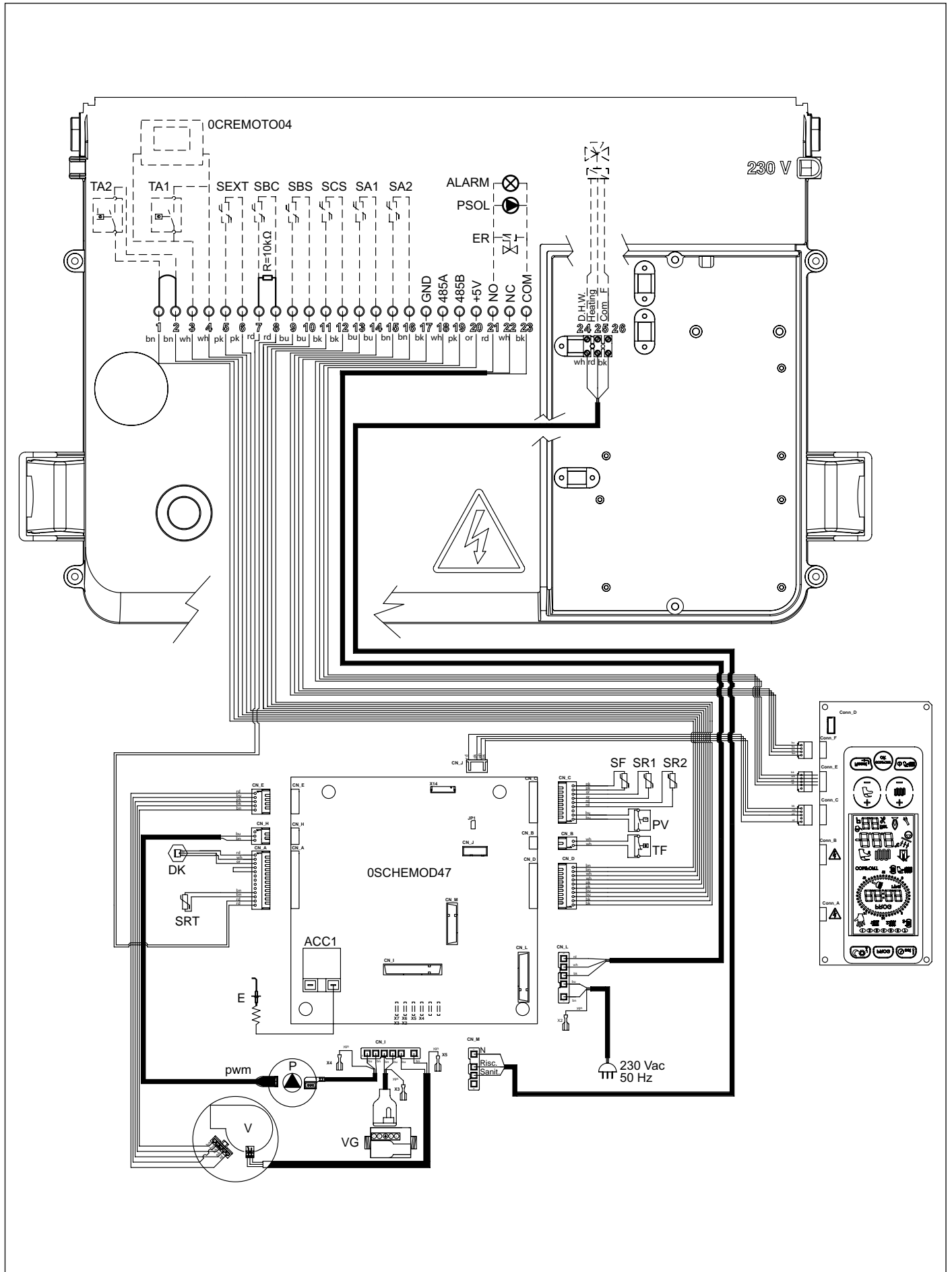

Fig. 34 Wiring diagram KR

Internal connections

- DK: pressure transducer
- SRT: return NTC temperature probe 10k Ohm a 25°C B=3435
- SR1-SR2: CH NTC temperature probe 10k Ohm a 25°C B=3435
- SF: flue gas NTC probe 10k Ohm a 25°C B=3435
- TF: flue gas thermostat
- PV: air pressure switch
- VG: gas valve
- P: boiler pump
- PWM: PMW signal cable for circulation pump
- E: ignition/flame detection electrode
- V: brushless fan
- ACC1: ignition transformer
- CN_A-CN_M: Load/signal connectors
- X2-X7: ground connectors

Connections performed by the installer

- 1-2: TA2 - ambient thermostat 2
- 3-4: OT or TA1 - Remote Control or ambient thermostat
- 5-6: SEXT - external probe (10K Ohm B=3977 at 25° C)
- 7-8: SBC - Boiler water heater probe (10K Ohm B=3435)
- 9-10: SBS - Solar water heater probe (PT1000)
- 11-12: SCS - Solar collector probe (PT1000)
- 13-14: SA1 - ambient probe 1
- 15-16: SA2 - ambient probe 2
- 17-18-19-20: 485 port for connection of additional boards
 - 17: GND
 - 18: A
 - 19: B
 - 20: +5V
- 21-22-23: Programmable relay
 - 21: line (NO normally open)
 - 22: line (NC normally close)
 - 23: neutral (COMMON)
- 24-25-26: 3-way deviating valve
 - 24: DHW (neutral, NC)
 - 25: heating (neutral, NO)
 - 26: phase (COMMON)

3.20.5 Forced circulation solar system with CH only boiler wiring diagram

Parameter setting

P03 : 3

P17 : 2

P18 : 1

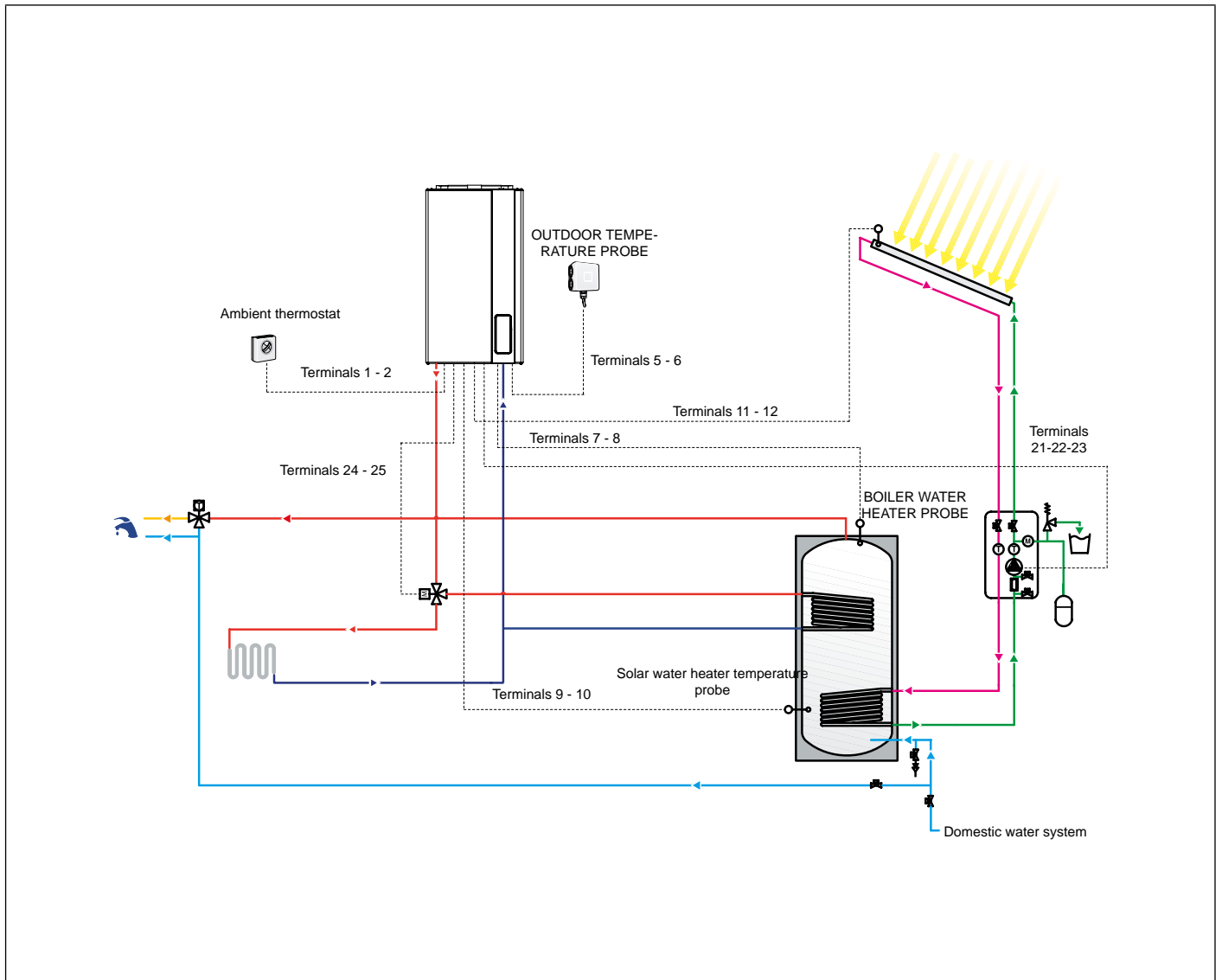

Fig. 35 Forced circulation solar system with CH only boiler wiring diagram

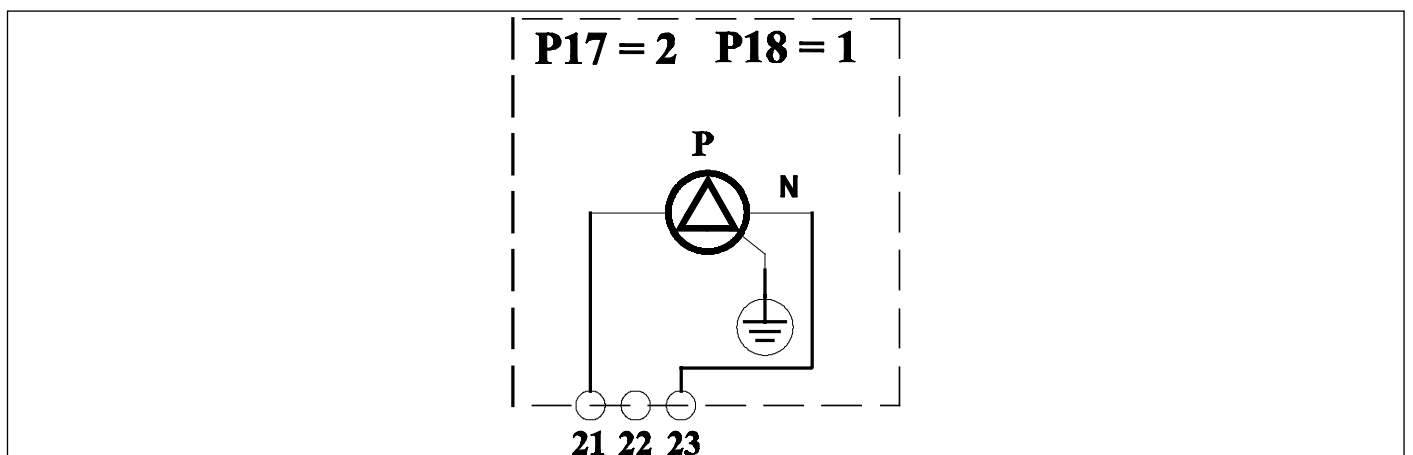

Fig. 36 Multifunction relay connection diagram

3.20.6 Wiring diagram KRB

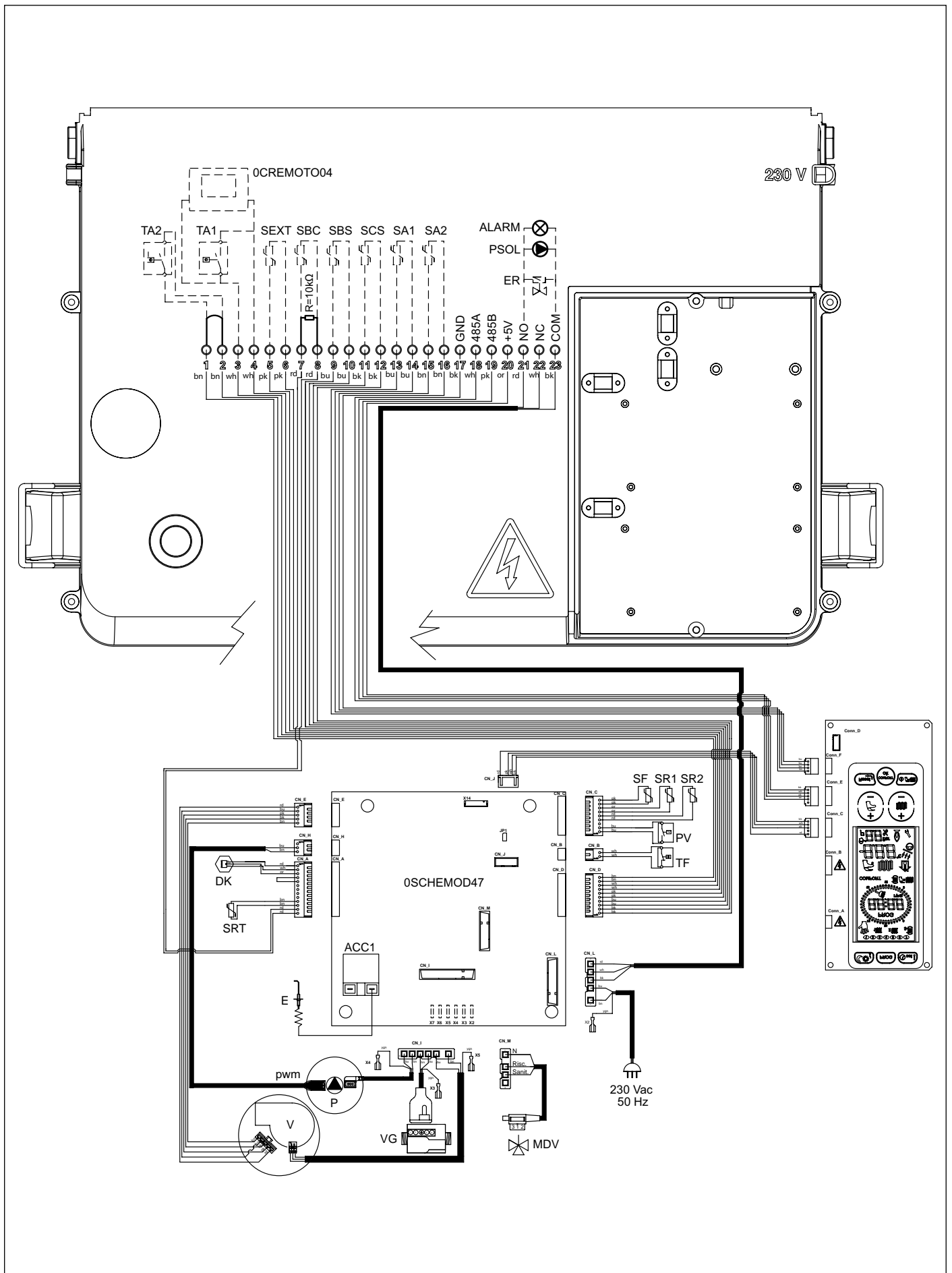

Fig. 37 Wiring diagram KRB

Internal connections

- DK: pressure transducer
- SRT: return NTC temperature probe 10k Ohm a 25°C B=3435
- SR1-SR2: CH NTC temperature probe 10k Ohm a 25°C B=3435
- SF: flue gas NTC probe 10k Ohm a 25°C B=3435
- TF: flue gas thermostat
- PV: air pressure switch
- VG: gas valve
- P: boiler pump
- PWM: PMW signal cable for circulation pump
- MDV: electric deviating valve
- E: ignition/flame detection electrode
- V: brushless fan
- ACC1: ignition transformer
- CN_A-CN_M: .. Load/signal connectors
- X2-X7: ground connectors

Connections performed by the installer

- 1-2: TA2 - ambient thermostat 2
- 3-4: OT or TA1 - Remote Control or ambient thermostat
- 5-6: SEXT - external probe (10K Ohm B=3977 at 25° C)
- 7-8: SBC - Boiler water heater probe (10K Ohm B=3435)
- 9-10: SBS - Solar water heater probe (PT1000)
- 11-12: SCS - Solar collector probe (PT1000)
- 13-14: SA1 - ambient probe 1
- 15-16: SA2 - ambient probe 2
- 17-18-19-20: ... 485 port for connection of additional boards
 - 17: GND
 - 18: A
 - 19: B
 - 20: +5V
- 21-22-23: Programmable relay
 - 21: line (NO normaly open)
 - 22: line (NC normaly close)
 - 23: neutral (COMMON)

3.20.7 Solar collector freeze protection function

Solar collector freeze protection is enabled by setting parameter **P24** = 1. With this function, solar pump is activated as soon as solar collector probe detects a temperature of 4° C

3.20.8 Collector heat transfer function

This function prevents that solar collectors in stagnation state are exposed to high thermal stresses.

With the boiler in SUMMER, WINTER or CH ONLY mode, if the temperature read by solar collector probe is between 110°C and 115°C (editable with parameter **P22**) and the temperature measured by the solar water heater probe is below 93 °C, solar pump is enabled to fill water heater. Solar pump operation is disabled as soon as solar collector temperature goes below 108 °C or solar water heater probe detects a temperature above 95°C.

3.20.9 Water heater cooling function

This function consists in cooling water heater down to the temperature value set by the user by transferring excess heat from the boiler to the solar collector.

With the boiler in SUMMER, WINTER or CH ONLY mode, if water heater temperature is 2°C higher than set-point temperature and collector probe temperature is 6°C lower than solar water heater probe temperature (editable with parameter **P20**), solar pump is enabled to cool water heater. Function is interrupted as soon as water heater temperature reaches the set-point value set by the user, or when solar collector probe temperature is 3°C lower than solar water heater probe temperature (editable with parameter **P21**). Function can be disabled with parameter **P26** (**P26** = 1 enabled; **P26** = 0 disabled).

3.20.10 Solar mode operation and failure function

When solar pump is active, symbol  appears on the display. If solar collector probe or solar water heater probe are faulty, error codes **E24** and **E28** will be displayed, respectively. Solar pump will be turned off.

3.20.11 Multifunction relay setting diagrams

The control panel features a multifunction relay, to be set through the parameter **P17-TSP17**

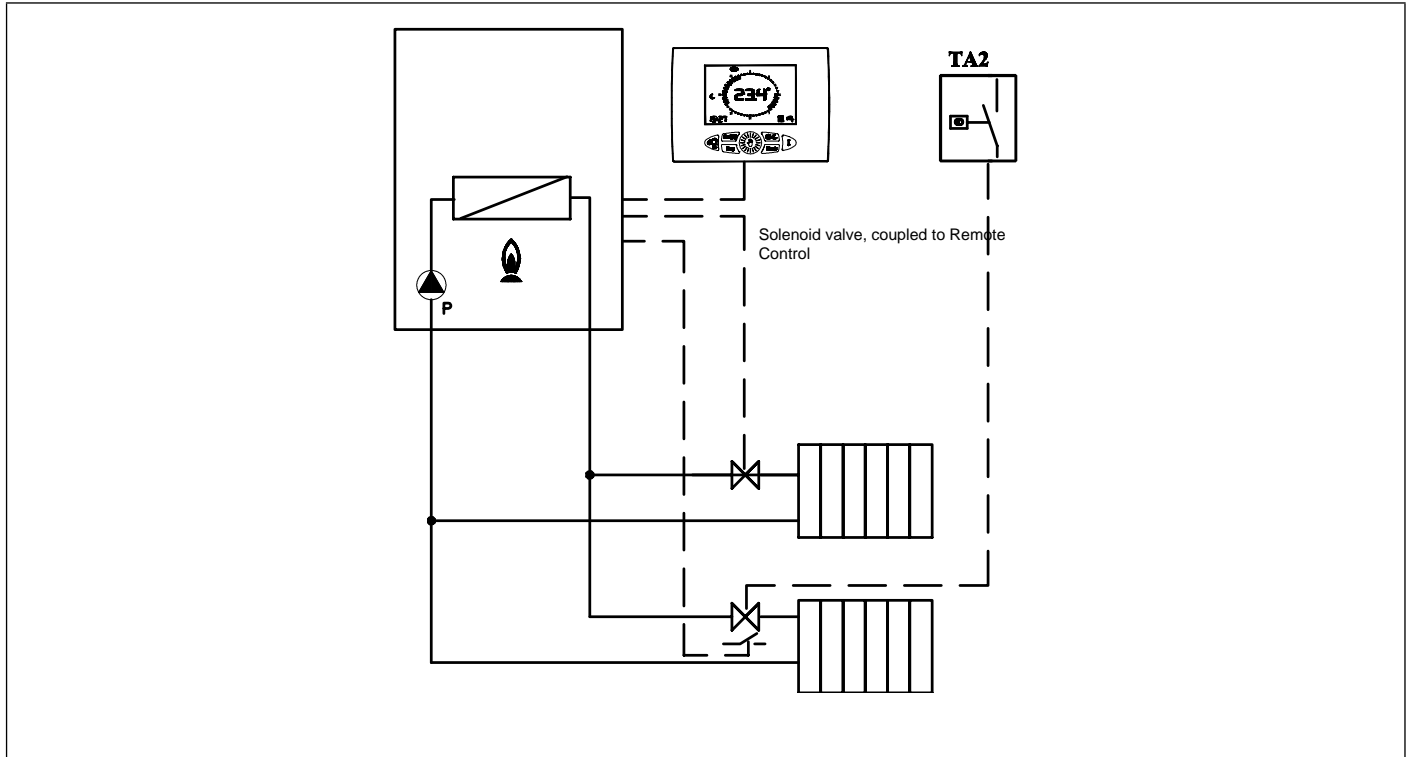

Fig. 38 Relay with remote control and TA2

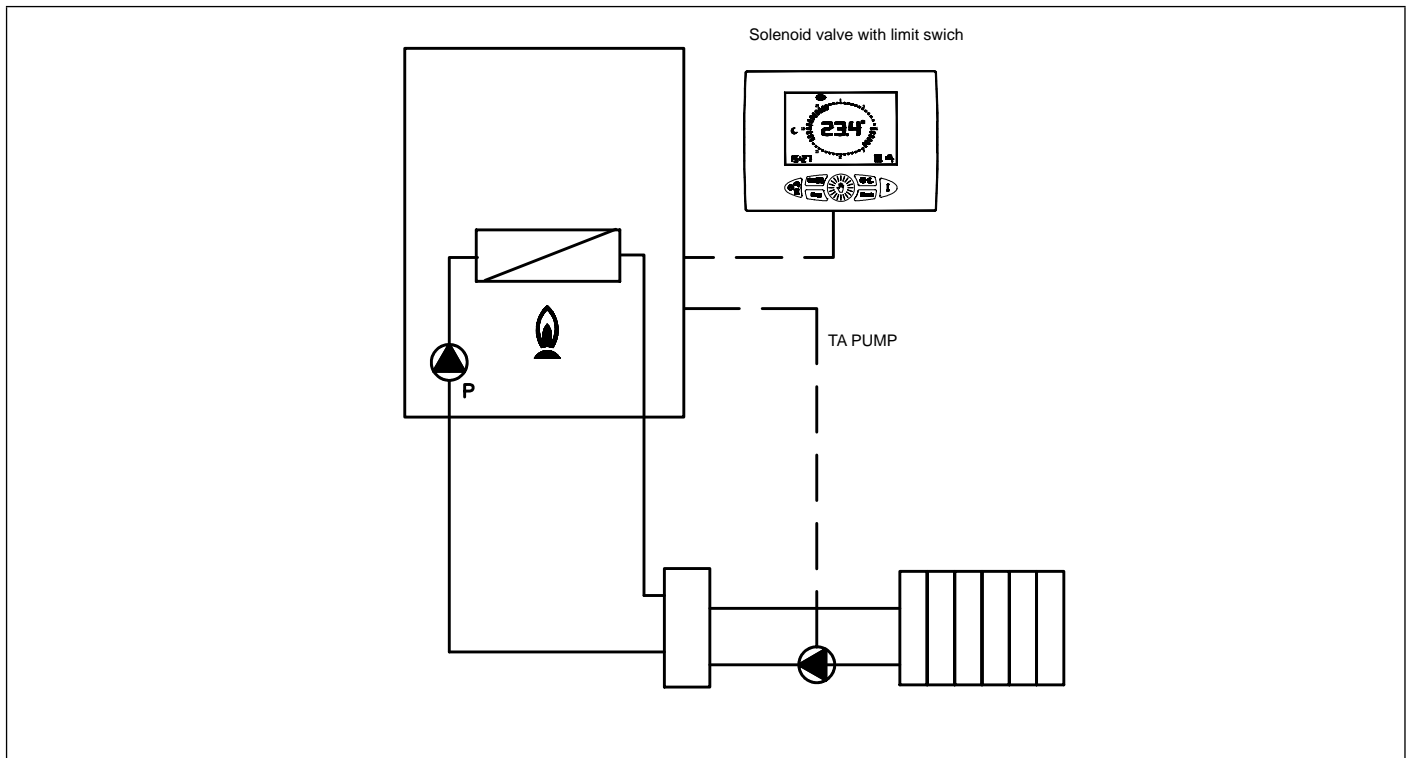

Fig. 39 Relay with remote request (P17=1)

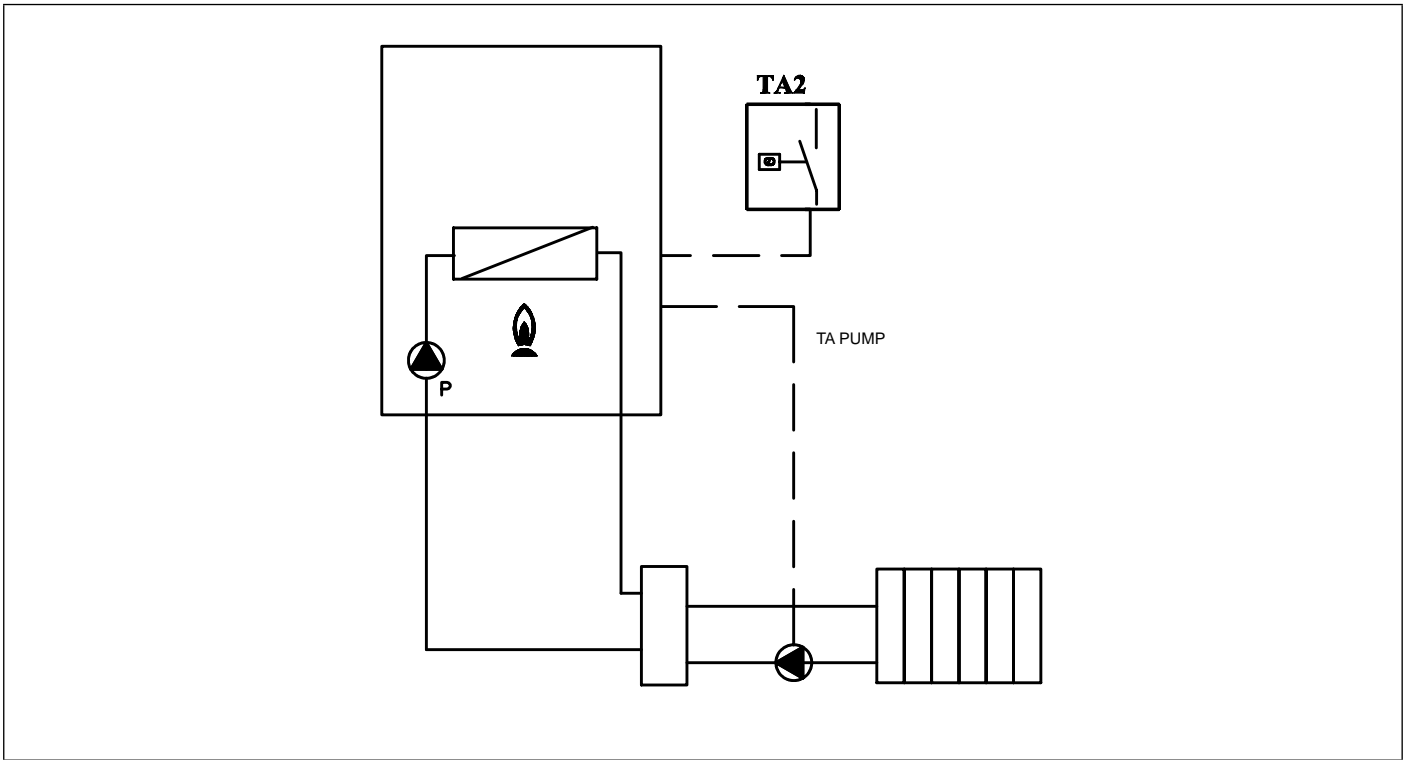

Fig. 40 Relay with TA2 request (P17 = 3)

DIAGRAM PARAMETER SETTING (SOLAR PLANT EXCLUDED)	P17
Error signalling relay	0
Relay controlled by TA1 or by the Remote Control	1
Relay controlled by TA2 or by the interface	3

Tab. 22 Parameter setting

3.20.12 Relationship between temperature and nominal resistance of all NTC probes (B=3435)

T (°C)	0	2	4	6	8
0	27203	24979	22959	21122	19451
10	17928	16539	15271	14113	13054
20	12084	11196	10382	9634	8948
30	8317	7736	7202	6709	6254
40	5835	5448	5090	4758	4452
50	4168	3904	3660	3433	3222
60	3026	2844	2674	2516	2369
70	2232	2104	1984	1872	1767
80	1670	1578	1492	1412	1336
90	1266	1199	1137	1079	1023

Tab. 23 Relationship between "Temperature and Nominal resistance" for temperature probes

3.21 Adaptation to other gas types and burner adjustment



WARNING

This boiler is built to run on the type of gas specified on the packaging and on the boiler rating plate. Any later transformation is to be exclusively carried out by qualified personnel, using manufacturer designed accessories and following the procedure and adjustment instructions for an accurate boiler setting-up.

3.21.1 Switching from NATURAL GAS to PROPANE

- Disconnect the boiler from the electric power supply.
- Remove boiler outer front panel.
- Loosen the three screws securing combustion chamber front panel to frame, then remove panel.
- Loosen the screw securing intake pipe to mixer, and remove pipe (see Fig. 41 Intake pipe).
- Disconnect the gas pipe from the mixer (see Fig. 41 Intake pipe).
- Loosen the three socket head screws, and remove the mixer (see Fig. 42 Mixer).
- Loosen the two retaining screws, and slide out mixer plastic body (see Fig. 43 Mixer plastic body).
- Using a 6 mm Allen wrench, loosen the two mixer nozzles (see Fig. 43 Mixer plastic body).
- Screw the new nozzles for propane listed in Tab. 25 Diameter of nozzles - diaphragms (mm), taking care to drive them fully home, without tightening.
- Only for KC/KR/KRB 32 versions, insert the 7.2 mm diaphragm on the outlet of the gas valve.



WARNING

In case the nozzle idles when reaching the bottom of the nozzle threaded seat, it means that the thread is damaged and perfect sealing is not ensured. The whole mixer shall be replaced.

- To refit the plastic body (Venturi), insert it inside mixer and secure it in place with the retaining screws. Take care not to damage the O-rings assembled on plastic body ends (see Fig. 43 Mixer plastic body) and to respect the assembling direction (see Fig. 44 Assembling direction).
- Refit the reassembled mixer onto the fan with the socket head screws, making sure to insert the O-ring between mixer and fan (see Fig. 43 Mixer plastic body).
- Reconnect boiler to electric power supply, and open the gas cock.
- Enter programme setting and set parameters **P4-P5-P6-P7-P8-P9** on the values for propane gas, as shown in Tab. 16 List of parameters - I.
- Adjust the gas valve (see par. *Gas valve setting* on page [86](#)).

3.21.2 Switching from PROPANE to NATURAL GAS

- Disconnect the boiler from the electric power supply.
- Remove boiler outer front panel.
- Loosen the three screws securing combustion chamber front panel to frame, then remove panel.
- Loosen the screw securing intake pipe to mixer, and remove pipe (see Fig. 41 Intake pipe).
- Disconnect the gas pipe from the mixer (see Fig. 41 Intake pipe).
- Loosen the three socket head screws, and remove the mixer (see Fig. 42 Mixer).
- Loosen the two retaining screws, and slide out mixer plastic body (see Fig. 43 Mixer plastic body).
- Using a 6 mm Allen wrench, loosen the two mixer nozzles (see Fig. 43 Mixer plastic body).
- Screw the new nozzles for methane listed in Tab. 25 Diameter of nozzles - diaphragms (mm), taking care to drive them fully home, without tightening.
- Only for KC/KR/KRB 32 versions, remove the 7.2 mm diaphragm on the outlet of the gas valve.



WARNING

In case the nozzle idles when reaching the bottom of the nozzle threaded seat, it means that the thread is damaged and perfect sealing is not ensured. The whole mixer shall be replaced.

- To refit the plastic body (Venturi), insert it inside mixer and secure it in place with the retaining screws. Take care not to damage the O-rings assembled on plastic body ends (see Fig. 43 Mixer plastic body) and to respect the assembling direction (see Fig. 44 Assembling direction).
- Refit the reassembled mixer onto the fan with the socket head screws, making sure to insert the O-ring between mixer and fan (see Fig. 43 Mixer plastic body).
- Reconnect boiler to electric power supply, and open the gas cock.
- Enter programme setting and set parameters **P4-P5-P6-P7-P8-P9** on the values for natural gas, as shown in Tab. 16 List of parameters - I.
- Adjust the gas valve (see par. *Gas valve setting* on page 86).

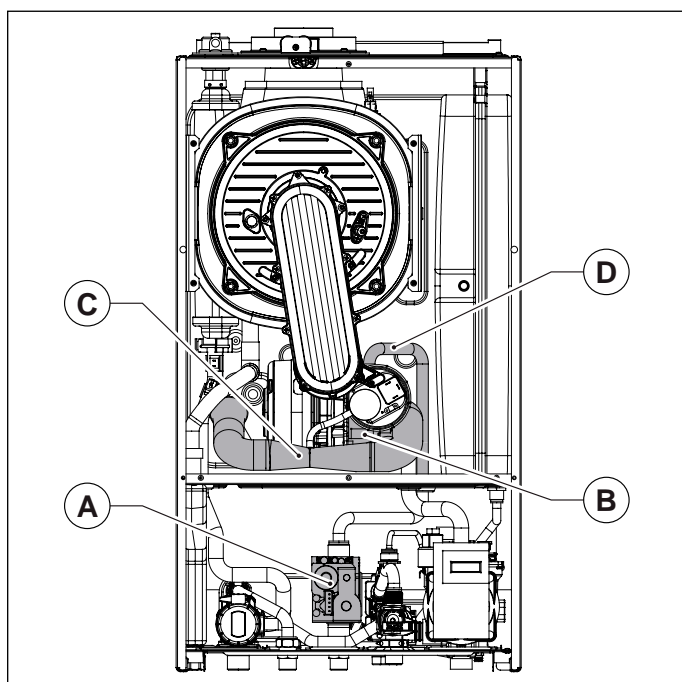

Fig. 41 Intake pipe

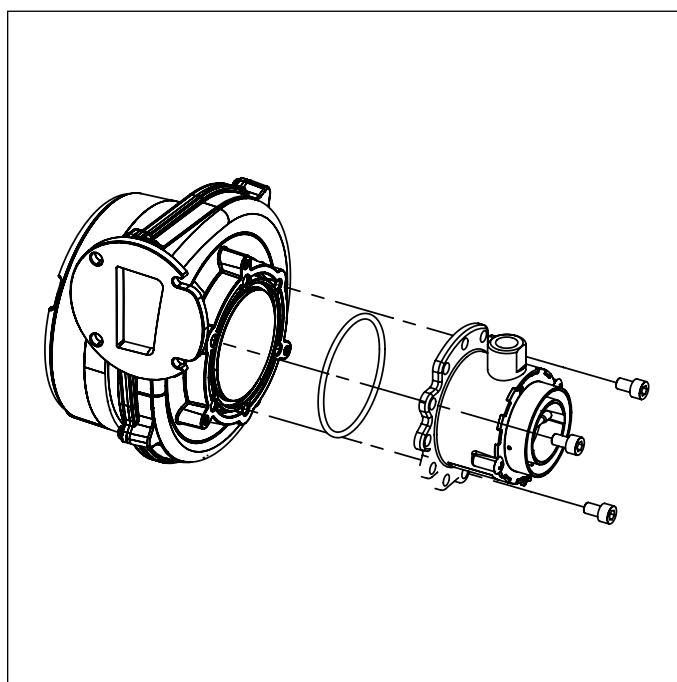

Fig. 42 Mixer

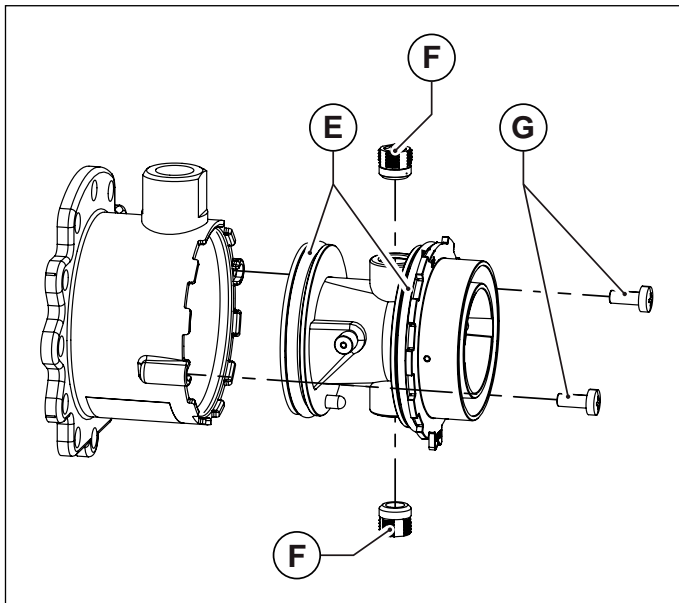

Fig. 43 Mixer plastic body

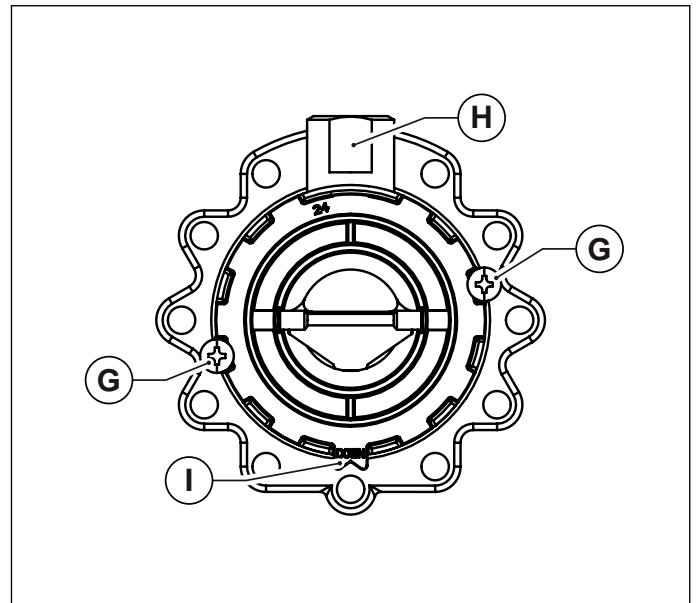





Fig. 44 Assembling direction

- A. Gas valve
- B. Mixer
- C. Air intake
- D. Gas pipe
- E. O-ring
- F. Nozzles
- G. Venturi to mixer retaining screws
- H. Gas fitting
- I. Direction tab

3.21.3 Gas valve setting

Maximum heating output adjustment

- Make sure that the ambient thermostat (optional), if fitted, is set to **ON**.
- Select the "heating" mode on the control panel pressing key  n times until symbol  is displayed.
- Start the 'flue cleaning' function by keeping  key pressed until symbol  stops flashing. Boiler switches to max. output operation.
- If a gas switching has been made, access the programming page and set the parameters **P0-P4-P5-P6-P7-P8-P9** based on the power and on the gas, as specified in Tab. 16 List of parameters - I.
- Set flue gas CO₂ content by turning the ratio adjuster **B** (see Fig. 45 Adjusting CO₂ value) and ensure that reading falls within the limits of Tab. 24 Flue CO₂ content. Let boiler flue cleaning function on and continue with the next point "Minimum heating output adjustment" .

Minimum heating output adjustment

- Set boiler min. output operation by keeping - **DHW** button pressed until the value corresponding to fan min. speed for the output and boiler gas is displayed (refer to Tab. 16 List of parameters - I.
- Boiler switches to min. output operation.
- Set flue gas CO₂ content by turning the offset control **C** (see Fig. 45 Adjusting CO₂ value) and ensure that reading falls within the limits of Tab. 24 Flue CO₂ content.
- Keep key  pressed to end the flue cleaning function.

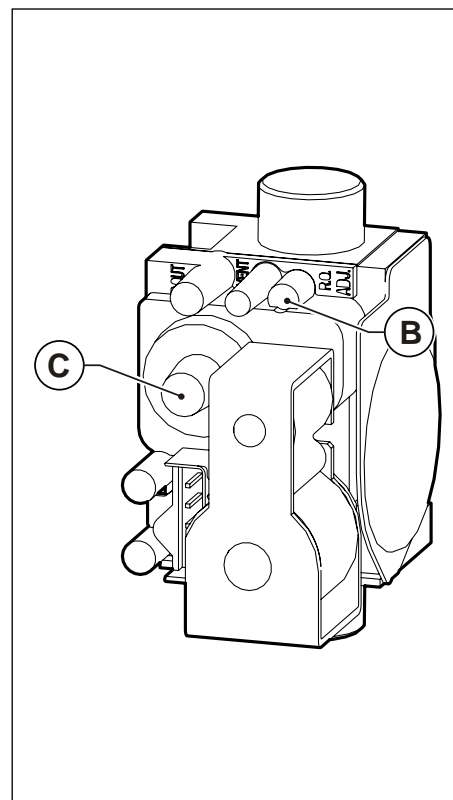

Fig. 45 Adjusting CO₂ value

Model	Flue CO ₂ value Max. output ⁽¹⁾ [%]	Flue CO ₂ value Min. output [%]
12 kW Natural gas	9.0 ± 0.3	9,3 ± 0,3
12 kW Propane	10.0 ± 0.3	10.3 ± 0.3
24 kW Methane	9.0 ± 0.3	9,3 ± 0,3
24 kW Propane	10.0 ± 0.3	10.0 ± 0.3
28 kW Methane	9.0 ± 0.3	9,3 ± 0,3
28 kW Propane	10.0 ± 0.3	10.3 ± 0.3
32 kW Methane	9.0 ± 0.3	9,3 ± 0,3
32 kW Propane	10.0 ± 0.3	10.0 ± 0.3

Tab. 24 Flue CO₂ content

Model	Natural gas	Propane
12 kW	3,05	2,50
24 kW	3,70	3,00
28 kW	4,00	3,30
32 kW	4,45	3.55 + diaphragm Ø 7.2

Tab. 25 Diameter of nozzles - diaphragms (mm)

4. Testing the boiler

4.1 Preliminary checks

Before testing the boiler, it is recommended to check the following:

- the flue gas venting duct and the relative terminal are installed in conformity with the instructions: **there must be no leakage of combustion by-products from any of the gaskets.**
- the supply power to the boiler must be 230 V ~ 50 Hz;
- the system is correctly filled with water (pressure gauge reading 1 to 1.3 bar);
- any shut-off cocks in the system pipes are open;
- the mains gas type is correct for the boiler calibration: convert the boiler to the available gas when necessary; this operation must only be performed by qualified technical personnel;
- the gas supply cock is open;
- **there are no fuel gas leaks;**
- the main switch installed ahead of the boiler is turned on;
- the 3-bar safety valve is not stuck;
- there are no water leaks;
- the condensate trap installed on the boiler is discharging condensate correctly and is not stuck.



WARNING

Should the boiler not be installed in compliance with the prevailing laws and standards, notify the system supervisor and do not test the boiler.

4.2 Switching on and switching off

To switch the boiler on and off, refer to the “**Instructions for the User**”.

5. Maintenance



WARNING

Any maintenance (and repair) work must only be carried out by qualified personnel.



WARNING

A proper boiler routine maintenance is an essential requirement to ensure safety.

The user is strongly advised to have the product serviced and repaired by a service centre or qualified personnel.



WARNING

Appropriate boiler maintenance ensures efficient operation, environment preservation, and safety for people, animals and objects.

The boiler must be serviced at least once every year.



WARNING

Disconnect electric power supply before starting any maintenance procedure, involving replacement of components and/or cleaning inside parts of boiler.

5.1 Maintenance schedule

Maintenance operations include check and cleaning procedures. In particular:

Inspections and checks

- Check general integrity of the boiler.
- Check boiler and network gas supply for leakage.
- Check gas supply pressure to boiler.
- Check boiler ignition sequence.
- Check boiler combustion parameters by flue gas analysis.
- Check the condition and seal integrity of the flue gas venting pipes.
- Check the state of combustion fan.
- Check integrity of safety devices of the boiler in general.
- Check for water leaks and oxidised areas on the boiler's couplings.
- Check efficiency of the system safety valves.
- Check expansion vessel filling pressure.
- Check correct draining of condensate from the condensate trap installed on the boiler.

The following cleaning is to be done

- Clean the general interior of the boiler.
- Clean the gas nozzles.
- Clean the air intake and flue gas venting circuits.
- Clean the heat exchanger.
- Clean the condensate trap and discharge ducts.
- Cleaning system filters (if any).

When checking the boiler for the very first time, also verify:

- Boiler room suitability.
- Diameter and length of flue gas system ducts.
- Boiler installation in accordance to this "Installation use and maintenance" manual instructions.



WARNING

Should the device not operate correctly, while not posing danger to people, animals or property, or should you find any discrepancy with reference to prevailing standards and regulations, notify the system supervisor both verbally and in writing.



WARNING

The manufacturer shall not be held responsible for damage to people, animals, or property due to tampering with or improper intervention to the boiler or failed/insufficient maintenance.

5.2 Combustion analysis

The combustion parameters of the boiler, which have to be checked in order to determine efficiency and emissions, must be measured in compliance with applicable legislation and standards.

5.3 Extraordinary maintenance

Extraordinary maintenance includes changing equipment components that are worn out or broken.



WARNING

Strictly comply with the instructions below.

Gas valve

The seals between gas valve and gas pipes must be replaced. And then checked for sealing.

The tightening torque for gas pipe fittings must be 23 Nm.

Gas valve calibration is mandatory: for calibration operations please strictly follow the procedures in paragraphs *Gas valve setting* on page 86, for details on these topics.

The perfect sealing of valve pressure taps must be checked.

Flame electronic control board

It is mandatory to set up the electronic board according to the boiler model, based on the instructions supplied together with the valve. In case of loss or doubts, contact the boiler manufacturer.

It is mandatory to set up the spare electronic board based on the gas type for which boiler is preset and its power.

For configuration, carefully follow the procedures in paragraph *TSP parameters* on page 62, to set parameter P0.

Make sure that all wirings have been correctly connected according to the wiring diagrams in paragraph *Wiring diagrams* on page 71.

Air pressure switch

The code and the calibration values of the spare part must comply with the product model on which it has to be installed, according to technical specifications table.

After replacement, both silicone pipes sealing and connection must be checked.

Safety thermostats and temperature probes

Spare part must be perfectly fastened and adhere to the element whose temperature must be measured.

Combustion fan

It is mandatory to properly position the seals in their seats and change any old ones with the new ones supplied together with the spare part.

Fasten the fan plate using all screws and check sealing.

Heat exchanger

In case of operations involving removing and/or changing the heat exchanger, all affected seals must be changed and sealing checked and ensured.

Ignition electrode and flame detection, inspection glass

In case of operations involving removing and/or changing the ignition electrodes and/or inspection glass, all affected seals must be changed and sealing checked and ensured.

Hydraulic components

In case of operations involving removing and/or changing any hydraulic components, all affected seals must be changed and sealing checked and ensured to avoid water leakage.

6. Decommissioning, disassembly and disposal



WARNING

Gas boilers are electrical and electronic equipment (EEE) and when decommissioned they become waste electrical and electronic equipment (WEEE), therefore, they must be disposed of in compliance with the legislation in force in the country of installation.

Gas boilers are classified as domestic appliances and must be disposed of in the same way as washing machines, dish washers and tumble dryers (R2 WEEE waste).

The disassembly of gas boilers and their disposal is therefore forbidden through channels not specifically provided for by law.

Decommissioning, disassembly and disposal operations must be performed with boiler cold and disconnected from gas and power mains.



WARNING

The user is not authorised to carry out such operations.

7. Malfunctions, possible causes and solutions

7.1 Troubleshooting

BOILER STATUS	MALFUNCTION	PROBABLE CAUSE	USER'S TASKS	QUALIFIED PERSONNEL'S TASKS
E01*	Burner does not ignite.	Gas supply failure.	Check gas supply. Check gas supply cock or gas network safety valve intervention.	
		Gas valve is disconnected.	Contact qualified personnel	Reconnect it.
		Gas valve is faulty.	Contact qualified personnel	Replace it.
		The board is faulty.	Contact qualified personnel	Replace it.
	Burner does not ignite: no spark.	Ignition relay is faulty.	Contact qualified personnel	Replace the electrode.
		Ignition transformer is faulty	Contact qualified personnel	Replace the ignition transformer.
		Electronic board does not ignite. It is faulty.	Contact qualified personnel	Replace electronic board.
	Burner ignites for a few seconds and goes off.	Electronic board does not detect flame: inverted phase and neutral.	Contact qualified personnel	Verify correct neutral and phase connection.
		Detection electrode cable is interrupted.	Contact qualified personnel	Reconnect or replace wire.
		Detection electrode is faulty.	Contact qualified personnel	Replace the electrode.
		Electronic board does not detect flame: it is faulty.	Contact qualified personnel	Replace electronic board.
		Ignition heat input setting is too low.	Contact qualified personnel	Increase it.
Minimum heat input is not set correctly.		Contact qualified personnel	Check burner setting.	
E02*	Flow temperature exceeded the max. allowed value.	Circulation pump is faulty.	Contact qualified personnel	Replace it.
		Circulation pump is seized.	Contact qualified personnel	Check pump electrical connection.
E03*	Flue thermostat triggering.	Poor flue draught.	Contact qualified personnel	Check air intake or flue gas venting system and vent grilles in the boiler room.
		Flue vent / air intake duct is obstructed.	Contact qualified personnel	Check for any duct obstruction, and eliminate.
		Flue gas thermostat is faulty.	Contact qualified personnel	Replace it.

BOILER STATUS	MALFUNCTION	PROBABLE CAUSE	USER'S TASKS	QUALIFIED PERSONNEL'S TASKS
E04**	CH system water pressure is low.	The system has been recently bled.	Fill the system (see section Boiler block). If the error occurs again several times, contact a qualified Service Centre or qualified personnel.	
		The system is leaking.	Check system.	
		Pressure transducer is disconnected.	Contact qualified personnel	Reconnect it.
		Pressure transducer is faulty.	Contact qualified personnel	Replace it.
E05**	Flow probe failure.	Flow probe is electrically disconnected.	Contact qualified personnel	Reconnect it.
		Flow probe faulty.	Contact qualified personnel	Replace it.
E06**	DHW probe failure (KC).	DHW probe is electrically disconnected.	Contact qualified personnel	Reconnect it.
		DHW probe faulty.	Contact qualified personnel	Replace it.
E07**	Flue gas probe failure.	Flue probe is electrically disconnected.	Contact qualified personnel	Reconnect it.
		Flue probe is faulty.	Contact qualified personnel	Replace it.
E08	Automatic filling procedure failure.	System pressure is not enough for filling (not enough water inside the system or no water at all).	Contact qualified personnel	Restore system pressure.
		Solenoid valve is obstructed.	Contact qualified personnel	Remove any obstruction inside the solenoid valve.
		Solenoid valve is faulty.	Contact qualified personnel	Replace it.
E09	System pressure is too close to the max. limit.	During manual filling, a system pressure too close to the safety valve drain value has been restored.	Progressively drain the system until the error symbol disappears.	
E12**	DHW inlet probe failure (KC).	Probe is disconnected.	Contact qualified personnel	Reconnect it.
		Probe is faulty.	Contact qualified personnel	Replace it.
E12**	Water heater probe (KR/KRB with optional external water heater fitted with NTC probe)	Probe is disconnected.	Contact qualified personnel	Reconnect it.
		Probe is faulty.	Contact qualified personnel	Replace it.

BOILER STATUS	MALFUNCTION	PROBABLE CAUSE	USER'S TASKS	QUALIFIED PERSONNEL'S TASKS
E15**	Return probe failure.	Probe is disconnected.	Contact qualified personnel	Reconnect it.
		Probe is faulty.	Contact qualified personnel	Replace it.
E24**	Solar collector failure.	Probe is disconnected.	Contact qualified personnel	Reconnect it.
		Probe is faulty.	Contact qualified personnel	Replace it.
E27**	Solar valve probe failure.	Probe is disconnected.	Contact qualified personnel	Reconnect it.
		Probe is faulty.	Contact qualified personnel	Replace it.
E28**	Solar water heater probe failure.	Probe is disconnected.	Contact qualified personnel	Reconnect it.
		Probe is faulty.	Contact qualified personnel	Replace it.
E31**	Remote Control connection failure (only shown on Remote Control display).	The Remote Control is not connected to boiler board.	Contact qualified personnel	Reconnect it.
		Remote control faulty.	Contact qualified personnel	Replace it.
		Boiler board is faulty.	Contact qualified personnel	Replace it.
E35**	Safety Thermostat triggering to protect the mixed "zone 2" (with zone kit "OKITZONE05" installed, only).	Mixer valve is faulty.	Contact qualified personnel	Replace it.
		Thermostat is disconnected.	Contact qualified personnel	Reconnect it.
		Thermostat is faulty	Contact qualified personnel	Replace it.
E36**	Flow probe failure on one of the installed zones.	Probe is disconnected.	Contact qualified personnel	Reconnect it.
		Probe is faulty.	Contact qualified personnel	Replace it.
E40*	Fan failure.	Fan disconnected.	Contact qualified personnel	Reconnect it.
		Fan faulty.	Contact qualified personnel	Replace it.
E41**	No communication between board and peripheral devices (panel interface and/or zone/solar boards).	Interface display is disconnected.	Contact qualified personnel	Reconnect it.
		Zone/solar boards are disconnected.	Contact qualified personnel	Reconnect them.
		Interface display and/or zone/solar boards are faulty.	Contact qualified personnel	Replace them.

BOILER STATUS	MALFUNCTION	PROBABLE CAUSE	USER'S TASKS	QUALIFIED PERSONNEL'S TASKS
E42	Solar system setting error.	Wrong boiler board or solar board setting parameters.	Contact qualified personnel	Check that the P03 and P18 parameter set values match with those specified on the reference tables.
E43	Zone configuration error (optional, if connected: Remote Control and ambient thermostat).	Wrong boiler board setting parameters.	Contact qualified personnel	Check that the P61 parameter set values match with those specified on the reference tables.
E44**	Ambient probe 1 failure.	Ambient probe is disconnected.	Contact qualified personnel	Reconnect it.
		Ambient probe is faulty.	Contact qualified personnel	Replace it.
E45**	Ambient probe 2 failure.	Ambient probe is disconnected.	Contact qualified personnel	Reconnect it.
		Ambient probe is faulty.	Contact qualified personnel	Replace it.
E46	Pressure transducer failure.	Pressure transducer is disconnected.	Contact qualified personnel	Reconnect it.
		Pressure transducer is faulty.	Contact qualified personnel	Replace it.
E49	The interface does not work.	The interface is faulty.	Contact qualified personnel	Replace interface.
E80*	The ΔT between flow and return is not within the limits.	Flow and/or return probes are faulty.	Contact qualified personnel	Replace them.
		Obstructed bypass pipe.	Contact qualified personnel	Remove any obstructions, or replace the pipe.
		The bypass valve is not assembled or wrongly assembled.	Contact qualified personnel	Restore bypass valve correct assembling.
		Heat exchanger primary circuit is obstructed.	Contact qualified personnel	Clean or replace the exchanger.
E86*	Flow temperature increases too quickly.	Pump is seized.	Contact qualified personnel	Unseize the pump.
		Pump is faulty.	Contact qualified personnel	Replace it.
E87*	Return temperature increases too quickly.	Pump is seized.	Contact qualified personnel	Unseize the pump.
		Pump is faulty.	Contact qualified personnel	Replace it.
		Condensate trap is clogged.	Contact qualified personnel	Check and clear the condensate trap.
		Flue probe is faulty.	Contact qualified personnel	Replace it.

BOILER STATUS	MALFUNCTION	PROBABLE CAUSE	USER'S TASKS	QUALIFIED PERSONNEL'S TASKS
E89***	Faulty flue temperature value.	Flue probe on heat exchanger is faulty or damaged.	Contact qualified personnel	Replace it.
E98	The max. number of resets from the boiler interface has been reached.	Max. number of reset attempts from boiler reached.	To reset the interface, disconnect boiler from power mains.	
E99	The max. number of resets from the Remote Control has been reached.	The user has reached the max. number of resettable values from the Remote Control.	To reset the interface, disconnect boiler from power mains.	

* errors that can be reset by the user by keeping the **RESET** button pressed

** self-resettable errors, they automatically reset as soon as the failure is fixed

*** errors that can be reset only by the Technical Service personnel

In case errors **E51**, **E52**, **E53**, **E73**, **E85**, **E89**, **E90** and **E91** might occur, contact a qualified service centre or personnel.

Page left intentionally blank

Page left intentionally blank

Page left intentionally blank



OLIBMEEN34

Fondital S.p.A. - Società a unico socio
25079 VOBARNO (Brescia) Italy - Via Cerreto, 40
Tel. +39 0365 878 31
Fax +39 0365 878 304
e-mail: info@fondital.it
www.fondital.com

The manufacturer reserves the right to modify his/her products as deemed necessary, without altering the basic characteristics of the products themselves.

Uff. Pubblicità Fondital IST 03 C 860 - 03 | Maggio 2019 (05/2019)